



control solutions

TERACOM



TCG140 GPRS remote IO module

Version 1.11/June 2020

USER MANUAL

1. Short description

TCG140 is a GSM-GPRS remote IO controller. It has 2 digital inputs, 4 analog inputs, digital interfaces for external sensors and 4 relays. Two of analog inputs can be switched either in a current (0-20mA) or voltage modes. The relays can be activated either remotely (via SMS or HTTP API command) or locally - from the status of the monitored parameter.

TCG140 supports all digital sensors of Teracom.

All monitored parameters and status of relays can be periodically saved in the embedded data logger. It is also possible to arrange records on any alarm condition.

The controller supports HTTP API for easy M2M communication. The GSM-GPRS remote IO controller can periodically send data to a remote server or can be polled by the server if data card with public static IP is used.

2. Features

- Quad-bands connectivity;
- GPRS data logger with up to 70000 records;
- Setup via USB, SMS and HTTP API;
- 2 digital "dry contact" inputs;
- Up to 4 analog inputs with 0 to 10VDC range;
- Up to 2 current loop (4-20mA) inputs;
- Settable multiplier, offset, and dimension for analog inputs;
- 4 relays with NO and NC contacts;
- 1-Wire support for all Teracom sensors;
- MODBUS RTU sensors support;
- SMS alarm alerts for up to 5 numbers;
- Email alarm alerts for up to 5 email recipients;
- Single call relay control for up to 5 numbers;
- Periodical HTTP post with current status in XML or JSON file to remote server;
- Periodical HTTP post with logger data in CSV format to remote server;
- HTTP API commands;
- Firmware update over USB or GPRS.

3. Applications

TCG140 is suitable for industrial automation, data acquisition systems, environmental monitoring, local control of an electrical and non-electrical parameter, building automation etc.:

- SCADA systems
TCG140 be easily integrated into SCADA systems. The periodical HTTP post is suitable for client-server configurations.
- Stand-alone data logger
The device can be used as a standard data logger with minimum record time as low as 1 minute. The logged data can be periodically uploaded to a dedicated server as CSV file.
- Environmental monitoring and control

4. Specifications

- Physical characteristics
 - Dimensions: 158 x 119 x 32 mm
 - Weight: 470 g
 - Mounting: wall and DIN rail
- Environmental limits
 - Operating Temperature: -20 to 55°C
 - Storage Temperature: -25 to 60°C
 - Ambient Relative Humidity: 5 to 85% (non-condensing)
- Standards and Certifications
 - Safety: EN 60950-1:2006+A11:2009+A1:2010+A12:2011+A2:2013, EN 62311:2008
 - EMC: EN 55022:2010, EN 55024:2010, EN 61000-3-2:2014, EN 61000-3-3:2013
EN 301489-1 V1.9.2, EN 301489-7 V1.3.1
 - RFSU: EN 301511 V9.0.2
 - Green Product: RoHS
- Warranty
 - Warranty period: 3 years
- Power requirements
 - Input Voltage: 10 to 24 VDC
 - Input Current: 340 mA @ 12 VDC
- Cellular interface
 - Standards: GSM/GPRS
 - Bands: 850/900/1800/1900 MHz
 - GPRS multi-slot class: 12, 1~12 configurable
 - GPRS terminal device class: Class B
 - Compliant to GSM Phase 2/2+: Class 4 (2W@850/ 900MHz), Class 1 (1W@1800/1900MHz)
 - SIM card size: Micro
 - Antenna connector: SMA-F
- Analog inputs
 - Isolation: Non isolated
 - Type: Single ended
 - Resolution: 10 bits
 - Mode (Analog inputs 1 and 2): Voltage
 - Mode (Analog inputs 3 and 4): Voltage / Current (WEB interface selectable)
 - Input Range: 0 to 10 VDC, 0 to 20 mA
 - Accuracy: ±1%
 - Sampling Rate: 500mS per channel (averaged value of 250 samples)
 - Input Impedance: 1 mega-ohms (min.)
 - Built-in resistor for current mode: 410 ohms
- Digital inputs
 - Isolation: Non isolated
 - Type: Dry contact
 - Sampling rate: 10mS
 - Digital filtering time interval: 30mS
- Relay outputs
 - Type: Form C (N.O. and N.C. contacts)
 - Contact current rating: 3 A @ 24 VDC, 30 VAC (resistive load)

Initial insulation resistance: 100 mega-ohms (min.) @ 500 VDC

Mechanical endurance: 10 000 000 operations

Electrical endurance: 100 000 operations @ 3 A resistive load

Contact resistance: 50 milli-ohms max. (initial value)

Pulse output: 0.1 Hz at rated load

- Digital sensor interfaces (1-Wire and RS-485)

Output voltage: 5.0 ± 0.3 VDC

Maximum output current (for both interfaces): 200 mA

- Internal FLASH memory

Endurance: 100 000 cycles (Every relay status and settings change is a memory cycle.)

5. Installation

This device must be installed by qualified personnel. The installation consists of mounting the device, connecting the GSM antenna, connecting inputs and outputs, providing power and configuring via a web browser. This device must not be installed directly outdoors.

Attention! Before installing the SIM card in the card slot, please ensure that the PIN code is disabled.

5.1. Mounting

TCG140 should be mounted in a clean and dry location on a not flammable surface. Ventilation is recommended for installations where ambient air temperature is expected to be high.

Mount the device to a wall by using two plastic dowels 8x60mm (example Würth GmbH 0912 802 002) and two dowel screws 6x70mm (example Würth GmbH 0157 06 70). See Appendix C, fig. 1 for mechanical details.

Maintain spacing from adjacent equipment. Allow 50 mm of space on all sides, as shown in fig.2 in Appendix C, this provides ventilation and electrical isolation.

For DIN rail mounting, a DIN-RAIL-MOUNT-KIT should be used.

5.2. Connectors

Attention! Disconnect power supply before wiring.

The correct wiring procedure is as follows:

- Make sure power is turned off;
- Make wiring connections to the terminals;
- Apply power.

It is recommended to test and configure TCG140 without any controlled device.

Make sure that wires are properly attached to the terminals and that the terminals are tightened. Not proper wiring and configuration can cause permanent damage to the controller or the equipment to which it is connected or both. Inputs and outputs locations are shown below:

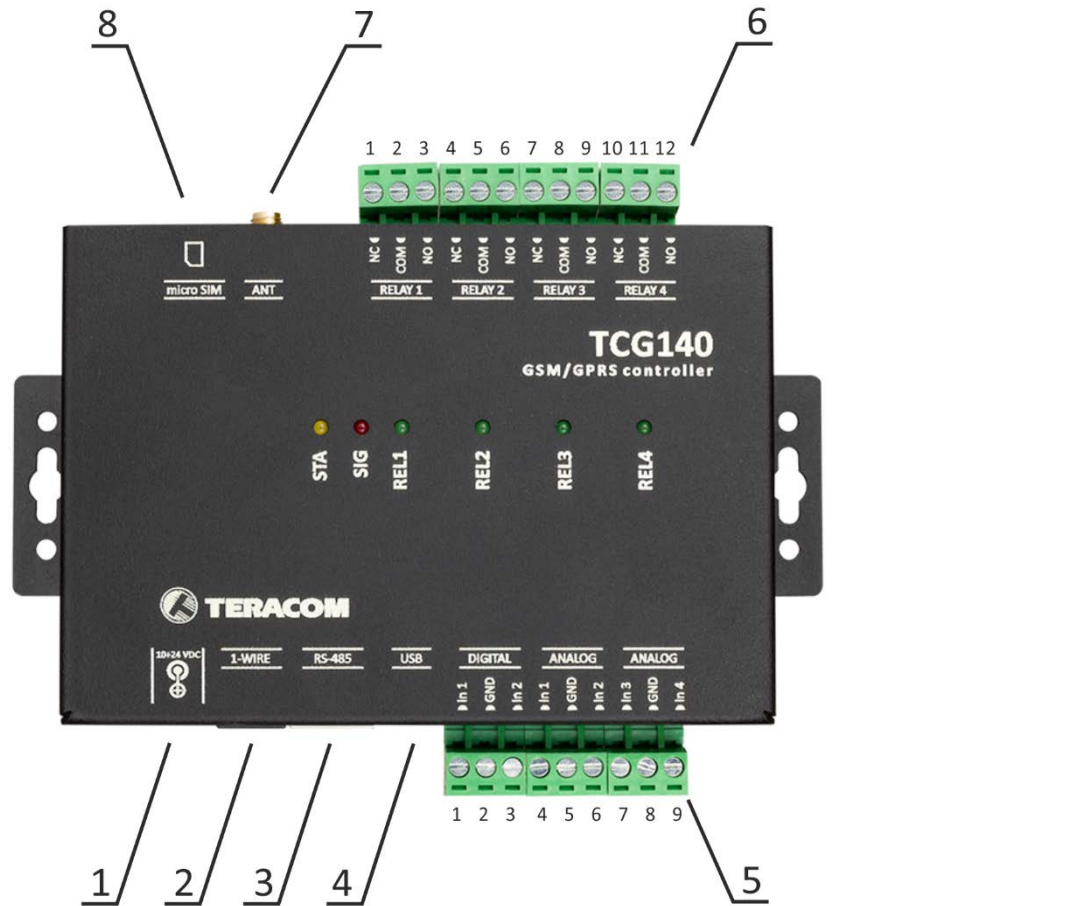

- | | |
|---|--|
| <p>Connector 1 Power - central positive</p> <p>Connector 2 Pin1 – GND(most left)
Pin2 – GND
Pin3 – 1-Wire data
Pin4 – 1-Wire GND
Pin5 – 1-Wire +VDD
Pin6 – 1-Wire +VDD(most right)</p> <p>Connector 3 RS-485
Pin1 – not connected (most left)
Pin2 – not connected
Pin3 – not connected
Pin4 – Line B-
Pin5 – Line A+
Pin6 – not connected
Pin7 – +VDD
Pin8 – GND</p> <p>Connector 4 mini USB</p> | <p>Connector 5 Pin1 – Digital In 1
Pin2 – Ground
Pin3 – Digital In 2
Pin4 – Analog In 1
Pin5 – Ground
Pin6 – Analog In 2
Pin7 – Analog In 3
Pin8 – Ground
Pin9 – Analog In 4</p> <p>Connector 6 Pin1 – NC Relay 1
Pin2 – COM Relay 1
Pin3 – NO Relay 1
Pin4 – NC Relay 2
Pin5 – COM Relay 2
Pin6 – NO Relay 2
Pin7 – NC Relay 3
Pin8 – COM Relay 3
Pin9 – NO Relay 3
Pin10 – NC Relay 4
Pin11 – COM Relay 4
Pin12 – NO Relay 4</p> <p>Connector 7 GSM Antenna</p> <p>Connector 8 SIM card holder</p> |
|---|--|

5.2.1. Power supply connection

TCG140 is designed to be supplied by adapter SYS1308-2412-W2E or similar, intended for use in the conditions of overvoltage category II. The power supply equipment shall be resistant to short circuit and overload in a secondary circuit.

When in use, do not position the equipment so that it is difficult to disconnect the device from the power supply.

5.2.2. 1-Wire interface

1-Wire is a registered trademark of Maxim Integrated Products, Inc. It is designed to connect several sensors over a short wiring. It is not suitable for long distances or environments with EMC interference.

The maximum number of sensors (1-Wire or RS-485) connected to TCG140 is 8.

The device supports temperature and humidity-temperature sensors. Connected sensors are automatically detected and appropriate dimension is assigned.

It is strongly recommended to use “daisy-chained” (linear topology) for multi-sensors systems:

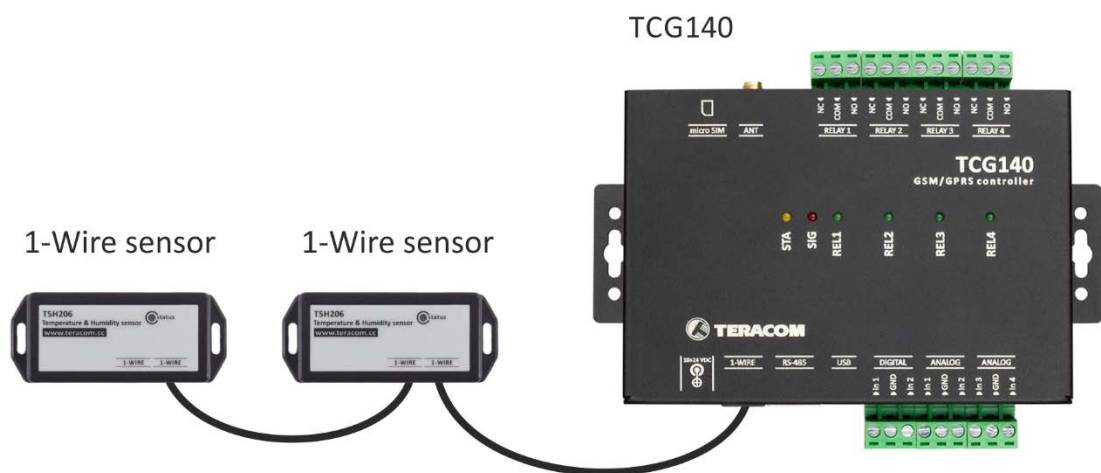

It is strongly recommended to use only UTP/FTP cables and keep total cable length up to 30m. Although functionality has been achieved in the longer distance, we cannot guarantee error-free operation over mentioned wiring length. We recommend reading Maxim’s 1-Wire tips at <http://www.maxim-ic.com/app-notes/index.mvp/id/148>.

We guarantee proper operation only with Teracom 1-Wire sensors.

5.2.3. RS-485 interface

RS-485 is a standard for serial communications systems defined by Telecommunications Industry Association (TIA) and Electronic Industries Alliance (EIA). Implementing the standard, communication systems can be used effectively over long distances and in electrically noisy (industrial) environments.

The maximum number of sensors (1-Wire or RS-485) connected to TCG140 is 8.

The device supports temperature and humidity-temperature sensors.

MODBUS RTU protocol specifies that address of the device should be between 1 and 247. The user should take care of appropriate address settings.

For multi-sensors systems “daisy-chained” (linear topology) should be used:

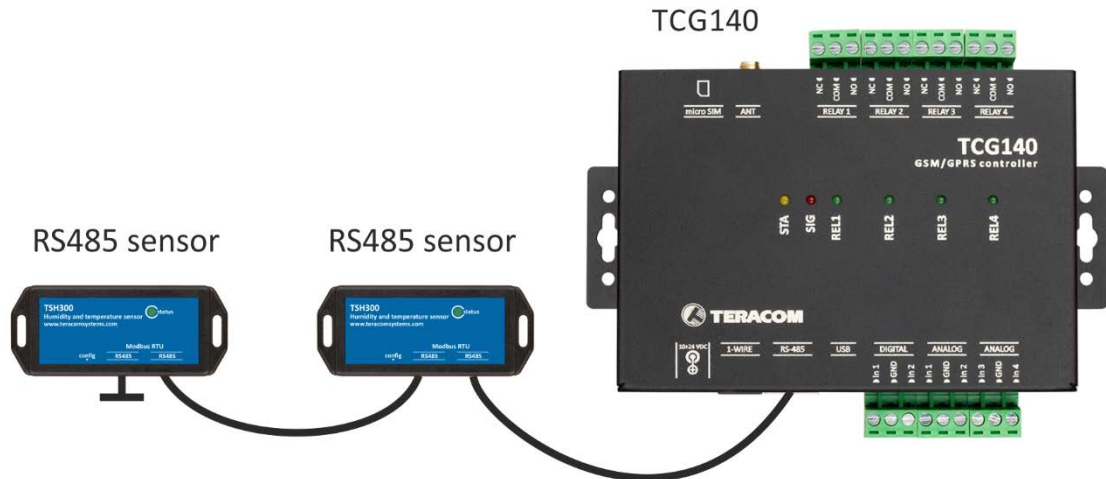

Interconnections are realized by UTP/FTP cables with RJ-45 connectors. The popular Ethernet wiring standard ANSI/TIA/EIA T568B is used:

It is recommended to use standard patch cables for LAN networks.

Special attention should be paid on termination of the bus in the last sensor.

We recommend keeping total cable length up to 30 m, although the RS-485 interface works over much longer distance.

Attention!

Special attention should be paid on termination of the bus.

The last sensor in the chain should have a terminator installed on the free RJ-45 socket.

5.2.4. Digital inputs connection

Attention! Digital inputs are NOT galvanic isolated.

The TCG140 digital inputs can be used as “dry contact” only.

The term “dry contact” means that to this input can be connected devices with an open drain or relay outputs - door contact switch, push button, PIR detector etc.

The following picture illustrates how an alarm button can be connected to a digital input of TCG140. One side of the contact is connected to “Digital In” while the other side is connected to “GND” terminal.

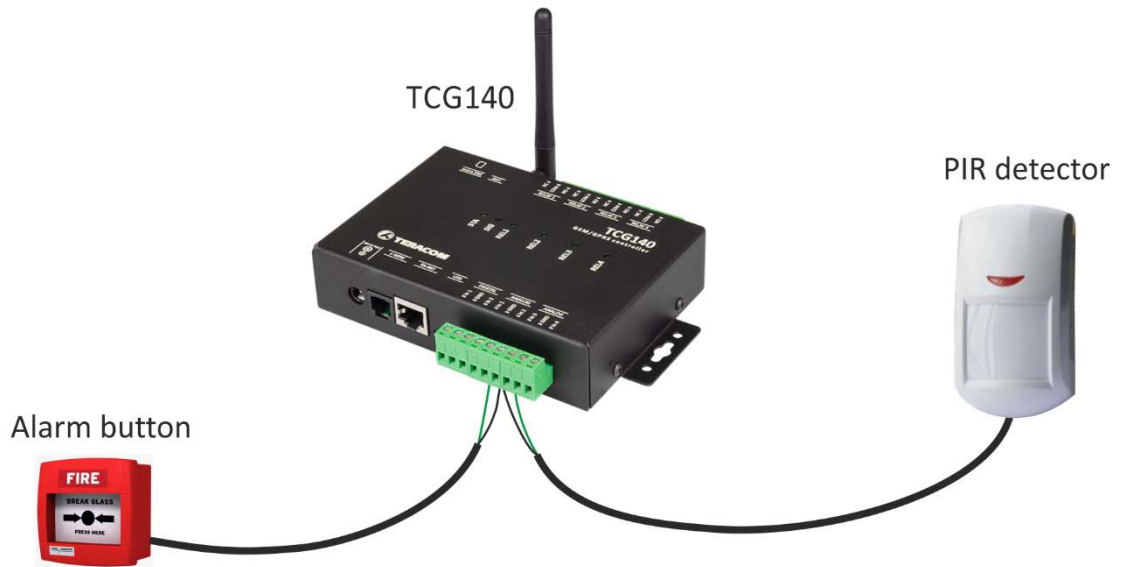

The maximum cable length for a digital input should be up to 30 meters.

5.2.5. Analog inputs connection

Attention! Analog inputs are NOT galvanic isolated.

Analog inputs of TCG140 can be used for monitoring of DC voltage up to 10VDC. They can be connected directly to sensors and transmitters with such analog output.

The “Multiplier”, “Offset” and “Dimension” for every analog input gives a possibility to monitor sensors with analog outputs and see directly the measured parameter.

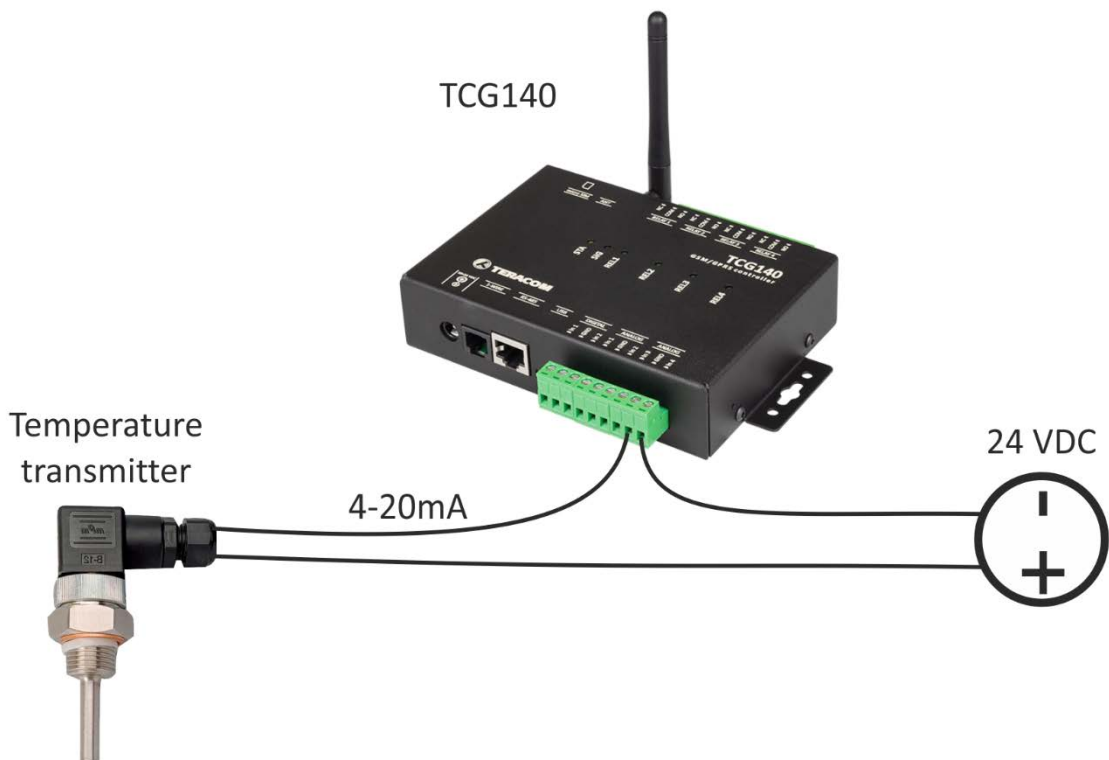

It is possible to monitor voltages bigger than 10VDC with adding an external resistor in series. For every 1 mega-ohm, the voltage will be extended with 5.893V. The external resistor should be with 1% or better accuracy.

To analog inputs 3 and 4 internally can be assigned 410-ohm resistor in parallel of the input. In this case, the input can accept directly 0-20mA current loop sensors and transmitters.

The switching of the resistor is done by the user interface.

The following picture illustrates how 0-10V analog sensor is connected to the analog input 1 and 0-20mA current loop transmitter is connected to analog input 3. The analog input 3 is in current mode.

The maximum cable length for an analog input should be up to 30 meters.

5.2.6. Sensors connection

Up to 8 1-Wire sensors can be connected to TCG140 controller. The device supports all Teracom 1-Wire sensors.

1-Wire is a registered trademark of Maxim Integrated Products, Inc. It is designed to connect several sensors over a short wiring. It is not suitable for long distances or environments with EMC interference. We recommend reading Maxim's 1-Wire tips at <http://www.maxim-ic.com/app-notes/index.mvp/id/148>.

The sensors have three wires – positive voltage (+VDD), ground (GND) and bidirectional data (Data). The colors of wires for every sensor are specified in its user manual.

It is strongly recommended to use “daisy-chained” (linear topology) for multiple sensors:

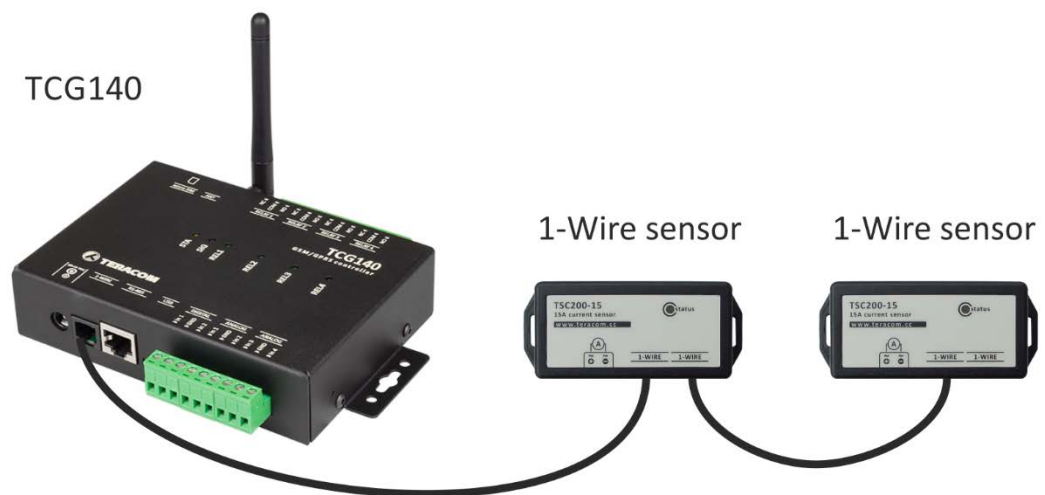

“Star” topology can be used only as a last resort for up to 4 sensors and total cable length up to 10 meters.

There are many parameters which determine the maximum length of the wires - type of cable, the number of sensors, ambient electromagnetic noise and sensor network topology.

It is strongly recommended to use only UTP/FTP cables and keep total cable length up to 30 m. Although functionality has been achieved in a longer distance, we cannot guarantee error-free operation over mentioned wiring length.

We guarantee proper operation only with Teracom 1-Wire sensors.

5.2.7. Relays connection

The relay contacts are internally connected directly to the terminal connectors. For all relays normally open, normally closed and common contacts are available. For loads with higher switchable current/voltage than specified, an external relay should be used.

When mechanical relays switch inductive loads such as motors, transformers, relays, etc., the current will arc across the relay contacts each time the contacts open. Over time, this cause wears on the relay contacts which shorten their life. When switching an inductive load, it is recommended that relay contact protection devices are used.

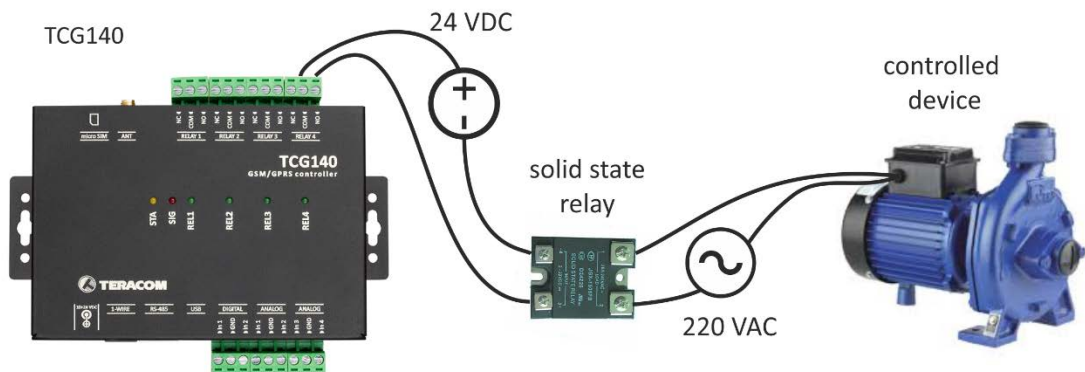

6. LED indicators

LED indicators show the status of the controller:

- **REL1 - REL4** (green) – the LED is ON when the corresponding relay is activated (the NO contact is connected to COM);
- **SIG** (red) – indicates the status of the device together with STA
- **STA** (yellow) – indicates the status of the device together with SIG.

The following states are displayed:

- **Controller initialization** – after power-on and firmware update SIG and STA turn ON for a second, after this turn OFF for another second.

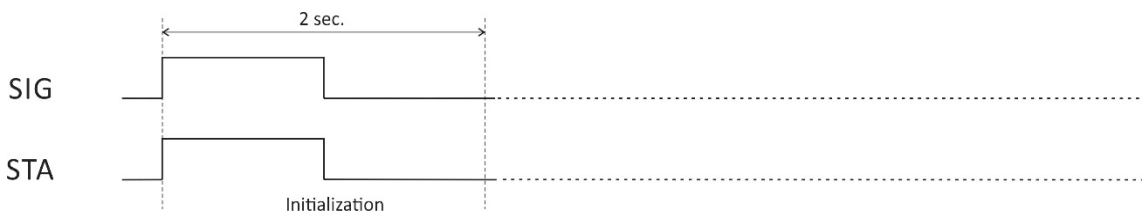

- **Searching for GSM network** – after initialization, SIG is OFF, STA flashes (flash length – 200ms)

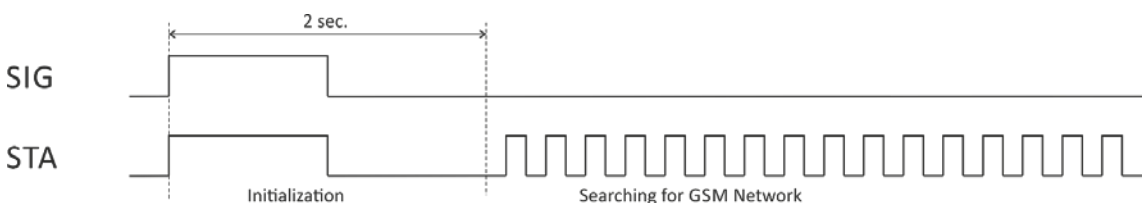

- **Connected to GSM network** – after successful connection to a mobile network, STA shows the type of connection, while SIG shows the signal strength.

STA flashes ones for 200mS in period of 2S – there is GSM connection only;

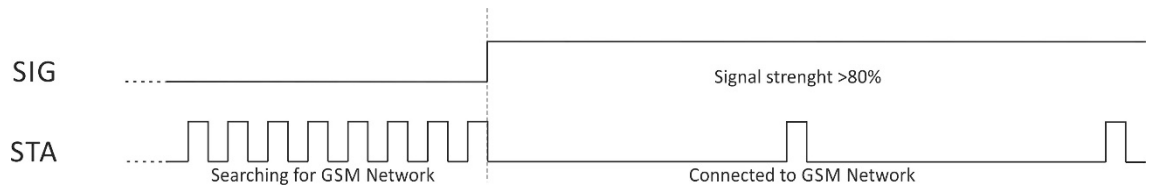

STA flashes twice for 200mS in a period of 2S – there is GSM and GPRS connection.

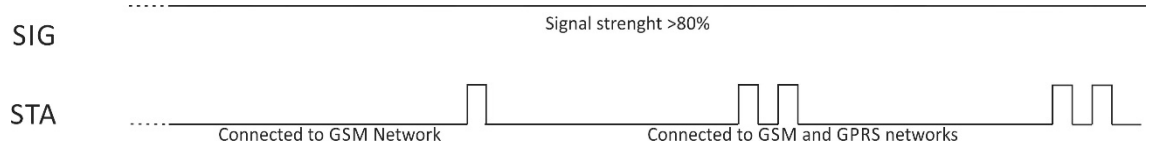

In the same time SIG has 5 states:

- SIG flashes 1 time in period of 2S – signal strength is between 0 and 20%;
- SIG flashes 2 times in period of 2S – signal strength is between 21 and 40%;
- SIG flashes 3 times in period of 2S – signal strength is between 41 and 60%;
- SIG flashes 4 times in period of 2S – signal strength is between 61 and 80%;
- SIG is solid ON – signal strength is between 81 and 100%;

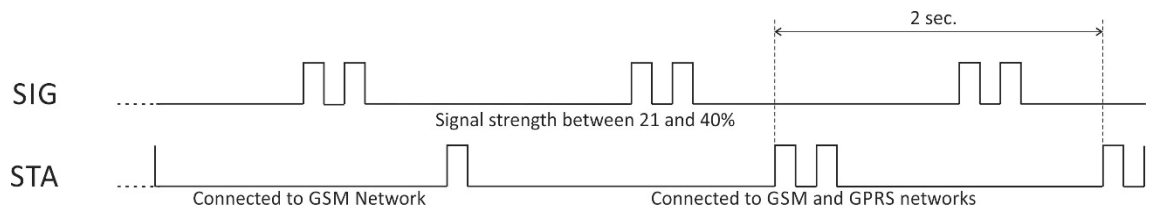
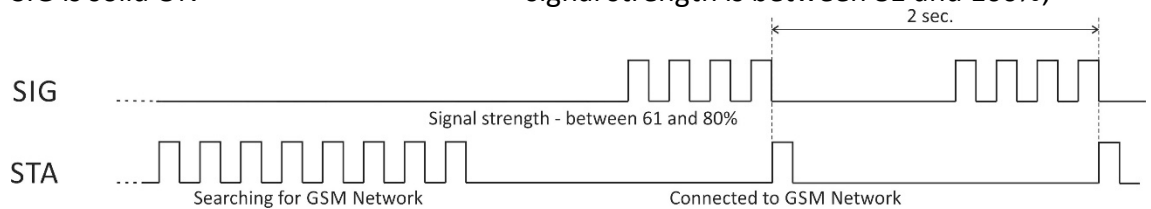

- **Error message** – in case of error after initialization, SIG will stay solid OFF, STA will flash showing the type of error.

- STA flashes ones for 1S – master phone number is not set;
- STA flashes permanently for 1S in a period of 2S – permanent hardware error.

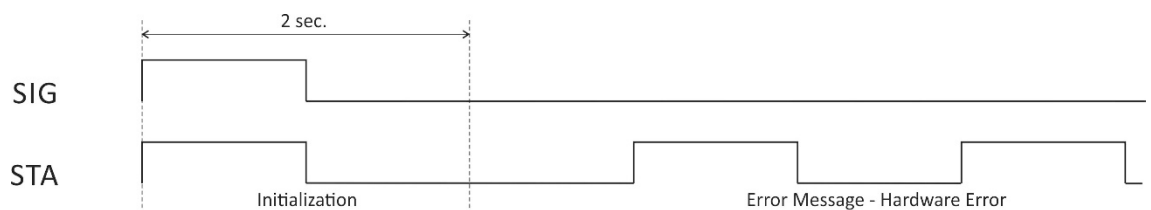
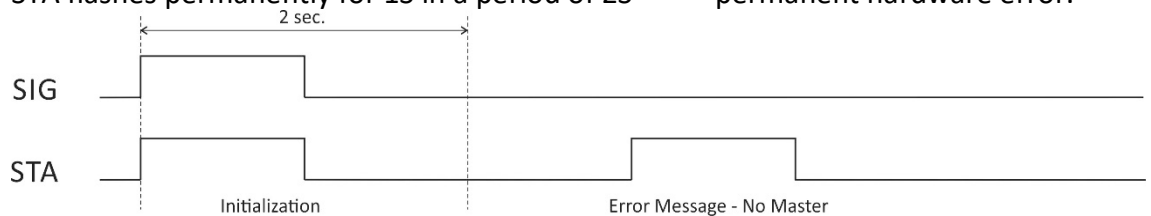

7. Initial setup via USB

The initial setup of TCG140 is done with a computer running Windows 7 or newer Microsoft Windows operating system. After power-up, the controller should be connected to the computer with USB cable. Once the USB cable is connected, the operating system automatically starts to install the drivers for the communication with the device. The following message appears:

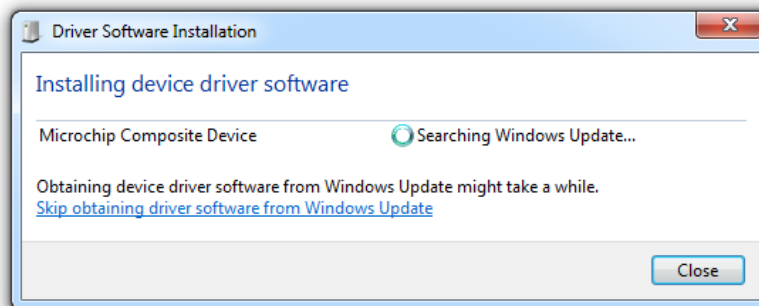

The following drivers will be installed:

- Microchip composite device
- USB serial port driver

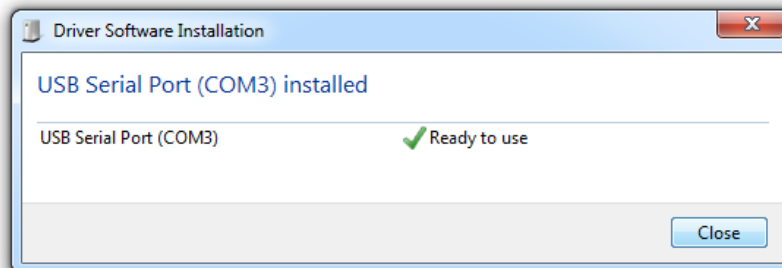

If for some reason the USB serial port driver cannot be installed automatically, it must be installed manually. The driver can be downloaded from the TCG140 product page at www.teracomsystems.com. After successful driver installation, the device will be recognized as Mass storage, the following window appears on the screen:

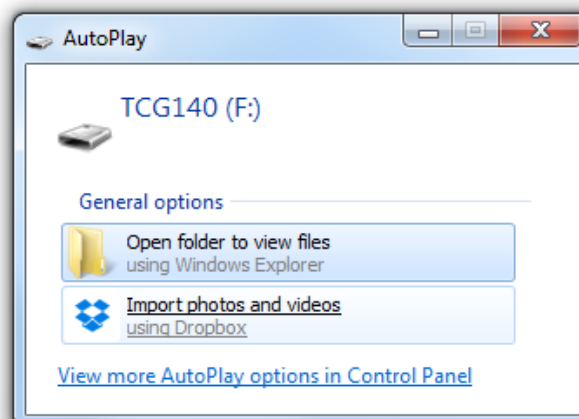

The only file stored on the mass storage is a tool called "TConfig". This tool enables the communication between the TCG140 and PC. After starting the TConfig tool, the following program will appear:

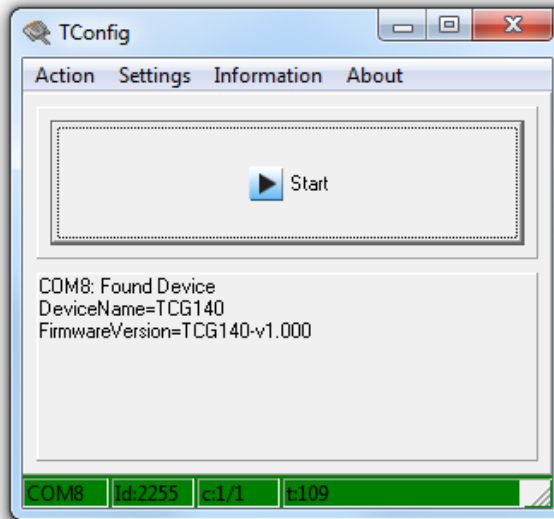

Pressing the “Start” button will start your web browser and display the Monitoring page of your TCG140.

7.1. Monitoring page

Monitoring page displays the current I/O state of TCG140. The page has 5 sections – “1-Wire sensors”, “Modbus sensors”, “Digital inputs”, “Analog inputs” and “Relays”.

For every parameter (sensor, input, relay) there is a description of up to 15 characters. The default descriptions can be changed in “Setup-Input/Output” menu.

The page can be automatically refreshed on an interval of 0 to 253 seconds. Zero means no automatic refresh. This parameter is set in section Setup->System->Monitoring page automatic refresh. By default, it is 1 second.

7.1.1. Sensors section

1-Wire sensors				
Pos	Description	Value 1	Value 2	ID
1	S1:TST1xx	24.2°C	-----	2867895F07000058
2	S2	-----	-----	0000000000000000
3	S3	-----	-----	0000000000000000
4	S4	-----	-----	0000000000000000

Modbus sensors					
Pos	Description	Value 1	Value 2	ID	Address
5	S5	24.0°C	-----	3300A118A1FFFF60	2
6	S6	23.9°C	47.8%RH	152DB379F9FFFF43	3
7	S7	-----	-----	0000000000000000	0
8	S8	-----	-----	0000000000000000	0

There are two sections on the page - one for 1-Wire sensors and one for MODBUS RTU sensors.

TCG140 supports up to eight sensors. They can be connected to both interfaces in a random ratio, settable in section “Sensors ratio setup” on Setup->Sensors page. By default, the number of MODBUS RTU sensors are 4.

All detected 1-Wire sensors are shown in “1-Wire sensors” section. The sensors should be setup in section “1-Wire sensors setup” on Setup->Sensors page.

All MODBUS RTU sensors are shown in “Modbus sensors” section. The sensors should be added and set up in section “Modbus RTU sensors” on Setup->Sensors page.

For every sensor, there are a description, value, ID and address information. The description length is up to 15 characters. Default descriptions can be changed in Setup->Conditions page.

Dual sensors (humidity-temperature) have the two parameters.

7.1.2. Digital inputs section

Digital input	Status	Digital input	Status
Digital Input 1	CLOSED	Digital Input 2	OPEN

Digital inputs can be used for monitoring the state of discrete devices – motion sensor, door contact, relay contact, alarm output etc.

Digital inputs are sampled every 10mS. The change of input status is considered valid if the same value is read in 3 consecutive samples (30mS).

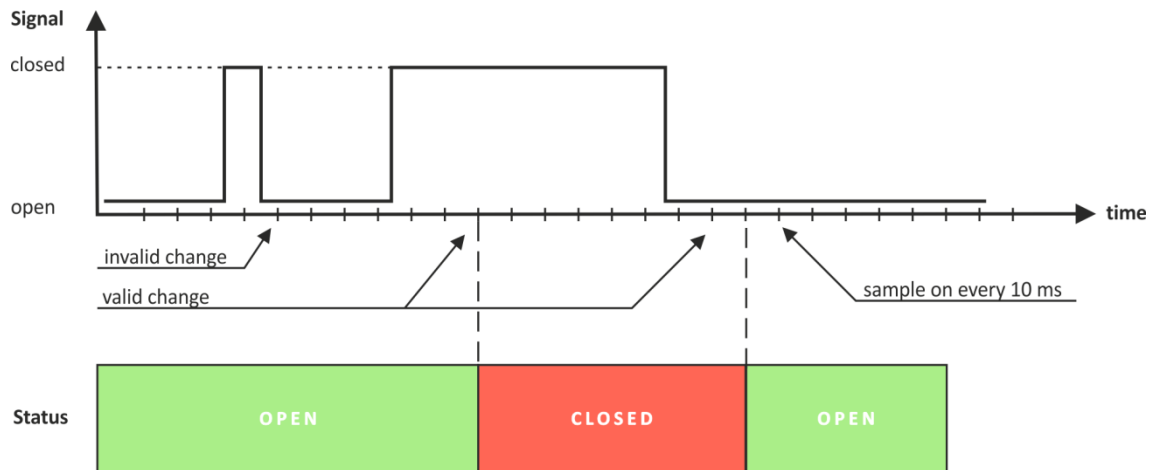

Status of every input is shown by text and by color.

The default descriptions and status names can be changed in “Setup-Input/Output”.

7.1.3. Analog inputs section

Analog input	Value	Analog input	Value
Analog Input 1	5.018V	Analog Input 2	0.021V
Analog Input 3	0.022V	Analog Input 4	0.031V

Analog inputs can be used for monitoring of DC voltage sources – analog sensors, batteries, power supplies, solar panels etc.

Analog inputs 3 and 4 can be also used for monitoring of 0-20mA current loop sensors/transmitters. The mode can be changed in “Setup-> Input/Output” section.

Analog inputs are sampled faster, but the new actual value is changed in 0.5 seconds. All 250 readings between the value changes are averaged.

For every analog input “Unit”, “Multiplier” and “Offset” can be set in “Setup-> Input/Output” section.

7.1.4. Relay section

Relay	Status	Control
Garage door	OFF	controlled by Phone call
Heating	OFF	controlled by S1:TST1xx Temperature
Relay 3	OFF	<input type="button" value="ON"/> <input type="button" value="OFF"/> <input type="button" value="Pulse"/>
Relay 4	OFF	<input type="button" value="ON"/> <input type="button" value="OFF"/> <input type="button" value="Pulse"/>
		<input type="button" value="All On"/> <input type="button" value="All Off"/> <input type="button" value="Pulse All"/>

The section displays the current state of relays. Each relay can be activated either remotely or locally from the status of a monitored parameter. For locally activated relays a text description of the controlling parameter is displayed rather than buttons.

Pulse duration and parameters for local relay activation can be set separately for each relay in "Setup->Input/Output->Relay outputs".

7.2. Setup

7.2.1. SMS/Call

SMS Setup		Alarm Notification	
Master	<input type="text" value="+359886224455"/>	<input type="checkbox"/>	Phone number format: [+][Country code][Network prefix][Number]
User 1	<input type="text"/>	<input type="checkbox"/>	
User 2	<input type="text"/>	<input type="checkbox"/>	
User 3	<input type="text"/>	<input type="checkbox"/>	
User 4	<input type="text"/>	<input type="checkbox"/>	
<input type="button" value="send test SMS"/>			

SMS alarm recipients can be set in this section.

The "Master" has special rights to change the device settings using SMS commands. This number always receive the SMS alarm messages.

The remaining 4 recipients can receive SMS messages if any of the parameters is in an alarm state. To receive the SMS messages for every number should be enabled with the checkbox "Alarm Notification". These 4 recipients can also ask by SMS for parameter state/value.

By pressing "send test SMS" button all SMS recipients will receive a test SMS.

All commands, their syntax, and answers are described in "Setup via SMS".

Phone call setup		
User 1	<input type="text" value="+359888112233"/>	Phone number format: [+][Country code][Network prefix][Number]
User 2	<input type="text"/>	
User 3	<input type="text"/>	
User 4	<input type="text"/>	
User 5	<input type="text"/>	

The relay outputs can be activated (pulse only) by a single call from an authorized number. The maximum number of the authorized numbers is five. These numbers can be set through the WEB interface or by sending an SMS from the Master.

7.2.2. Sensors

7.2.2.1. Sensors ratio setup

Sensors ratio setup

Number of 1Wire sensors

Number of Modbus sensors

The ratio between 1-Wire and MODBUS RTU sensors can be set here. By default, it is 4:4.

7.2.2.2. 1-Wire sensors setup

1-Wire sensors setup

Pos	Description	Value 1	Value 2	ID	Lock
1	S1:TST1xx	19.3°C	-----	2867895F07000058	<input type="checkbox"/>
2	S2	-----	-----	0000000000000000	<input type="checkbox"/>
3	S3	-----	-----	0000000000000000	<input type="checkbox"/>
4	S4	-----	-----	0000000000000000	<input type="checkbox"/>

Detection is made either after power on or by the button “Scan for new sensors”. All found sensors are shown in ascending order refer their unique ID number.

It is possible to lock a 1-Wire sensor in a specific position. To do this all sensors should be added one by one. After every addition, a new scan should be made and a newly found sensor should be locked in its position. If all sensors are locked, removing one “in the middle” will not change the positions of other sensors after reset. This option is very useful when TCG140 is used as a part of a monitoring and control system managed by HTTP API commands.

7.2.2.3. MODBUS RTU communication setup

Modbus RTU communication setup

Bit rate	<input type="text" value="19200"/>	Scan time-out for a sensor, ms	<input type="text" value="100"/>	Max scan time:	24700
Parity	<input type="text" value="even"/>	First address	<input type="text" value="1"/>		
Stop bits	<input type="text" value="1"/>	Last address	<input type="text" value="247"/>		

Found: 4 sensors with following addresses: 1,2,3,4

TCG140 supports MODBUS RTU over RS-485 interface. All sensors connected to this interface should work with the same communication settings.

By default, TCG140 works with the standard for MODBUS RTU settings – 19200, E, 1.

In the right part of the section, there is a tool for scan the MODBUS RTU interface. To optimize scan time, the appropriate address segment should be set up after this, the button “Save” on the bottom of the page should be pressed.

7.2.2.4. MODBUS RTU sensors

Modbus RTU sensors

Pos	Sensor address	Data type	Data order	Register 1		Register 2		Response time-out, ms (10-500) ms
				Address	Raw value	Address	Raw value	
5	<input type="text" value="2"/>	<input type="text" value="float"/>	<input type="text" value="MSW first"/>	<input type="text" value="100"/>	24.7	<input type="text" value=""/>	---	<input type="text" value="100"/>
6	<input type="text" value="3"/>	<input type="text" value="float"/>	<input type="text" value="MSW first"/>	<input type="text" value="100"/>	24.7	<input type="text" value="102"/>	46.7	<input type="text" value="100"/>
7	<input type="text" value="0"/>	<input type="text" value="float"/>	<input type="text" value="LSW first"/>	<input type="text" value=""/>	---	<input type="text" value=""/>	---	<input type="text" value=""/>
8	<input type="text" value="0"/>	<input type="text" value="float"/>	<input type="text" value="LSW first"/>	<input type="text" value=""/>	---	<input type="text" value=""/>	---	<input type="text" value=""/>

Max response time-out:

Polling time:

[Modbus sensors setup tool](#)

TCG140 supports Teracom and third-party MODBUS RTU sensors.

For every sensor, appropriate register addresses should be set. It is possible to change the multiplier, data order and data type for these sensors. Float and signed integer, with a multiplier, formats are supported.

All changes should be saved. If the settings are OK in the columns “Raw value” the right data will be shown.

TCG140 supports MODBUS RTU sensors with response time-out between 10 and 500mS. The response time-out for a new sensor is 100mS by default but it is recommended to use minimum response time guaranteed by the sensor’s manufacturer.

The sum of chosen response time-out for every sensor forms the maximum response time-out for the system.

The polling time is the time between two sequential readings of the same sensor. The chosen polling time determines the system's time of reaction. By default, it is 1 second.

Important: The maximum response time-out can’t be lower than the polling time.

7.2.2.5. Sensor setup tool

The link for the tool is available on the bottom of the Modbus RTU sensors paragraph. It can be used for sensor communication setup changes or just to read information from a register.

7.2.2.5.1. Communication setup

The section is similar to the general MODBUS RTU communication setup. The only new field is the sensor address.

The changes of settings in this section are not memorized and don’t change the general settings of TCG140.

The screenshot shows the 'Communication setup' interface. It includes fields for Bit rate (19200), Parity (even), Stop bits (1), Time-out (100), First address (1), Last address (20), and MB Address (1). A 'Scan' button is present, and the result shows 'Found: 4 sensors with following addresses: 1,2,3,4'.

7.2.2.5.2. Sensor communication register setup

This part of the tool is used for check and change the status of communication registers of the sensor.

The screenshot shows the 'Sensor communication register setup' interface. It includes fields for Bit rate register # (11), Parity, stop register # (12), Address register # (10), Value (19200), Value (1), and Value (1). There are 'Read' and 'Write' buttons, and a range indicator '(1 -- 247)'.

7.2.2.5.3. Sensor register check

The screenshot shows the 'Sensor register check' interface. It includes fields for Start address (100), Data type (float), Number of registers to read (2), Data order (MSW first), and Row value (23.882). There is a 'Read' button.

This part of the tool is used for general sensor register check.

7.2.3. Input/Output

7.2.3.1. Sensors

Sensors				
Sensor #	Description	Unit	Multiplier	Offset
S1	S1:TST1xx	°C	1.000	0.00
S2	S2	°C	1.000	0.00
S3	S3	%RH	1.000	0.00
S4	S4	°C	1.000	0.00
S5	S5	%RH	1.000	0.00
S6	S6	---		
S7	S7	---		
S8	S8	---		

For every sensor, a description, up to 15 symbols can be set. These descriptions will appear in the monitoring page, conditions page, XML/JSON data, SMS and e-mail alerts.

7.2.3.2. Digital inputs

Digital inputs			
Input #	Description	Low level	High level
DI1	Door	CLOSED	OPEN
DI2	Fuel	Empty	Full

For every digital input, a description, up to 15 symbols and states up to 15 symbols can be set. These descriptions will appear in the monitoring page, conditions page, XML/JSON data, SMS and e-mail alerts.

7.2.3.3. Analog inputs

Analog inputs					
Input #	Description	Unit	Multiplier	Offset	Type
AI1	Battery	VDC	1.000	0.0000	
AI2	Sensor	kg	1.600	0.0000	
AI3	Tank Level	mBar	50.000	0.0000	4-20ma
AI4	Analog Input 4	V	1.000	0.0000	voltage

For every analog input, a description, up to 15 symbols can be set. These descriptions will appear in the monitoring page, conditions page, XML/JSON data, SMS and e-mail alerts.

For every analog input, fields "Unit", "Multiplier" and "Offset" are available to convert the raw voltage/current into meaningful engineering units. The scaled value is calculated by:

$$SV[Un] = RV * MU + OF$$

Where:

SV – scaled (displayed) value;

Un – unit;

RV – raw voltage from the source;

MU – multiplier;

OF – offset.

Example:

For humidity sensor HIH-4000-003 following data (from the datasheet) is available:

VOUT = 0.826 at 0% RH

VOUT = 3.198 at 75.3% RH

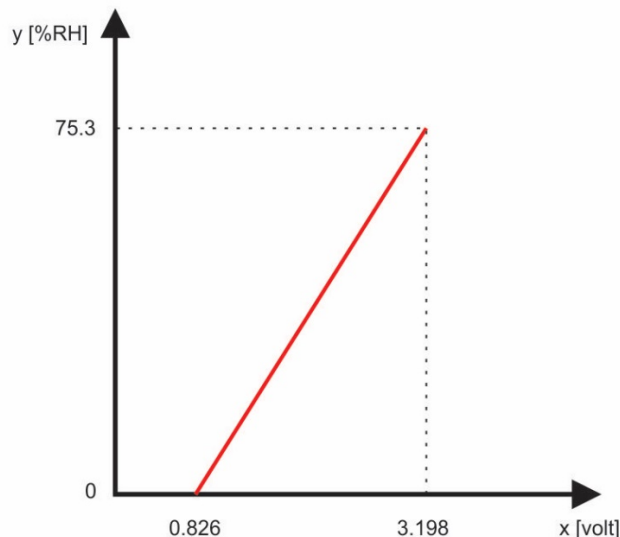

The raw values are voltages on the sensor's output. Actually, we need to know relative humidity (scaled value) not voltages. The two relations are enough to calculate multiplier and offset. When we know them we can calculate what relative humidity corresponds to every voltage in the working range.

The multiplier (MU) is calculated as $\Delta Y/\Delta X$, for this sensor $\Delta RH\%/\Delta V$:

$$MU = (75.3 - 0)/(3.198-0.826) = 75.3/2.372 = 31.745 \%RH/V$$

The offset is calculated from the already known multiplier and relation for one of the points:

$$OF = MU * (0 - VOUT1) + RH1 = 31.745*(0-0.826) + 0 = 31.745*(-0.826) = -26.22$$

The same result can be calculated for the second point:

$$OF = MU * (0 - VOUT2) + RH2 = 31.745*(0-3.198) + 75.3 = -101.52 + 75.3 = -26.22$$

For this sensor, the formula will look like:

$$SV = RV * 31.745 - 26.22$$

Check for $VOUT = 0.826 V (0\%RH)$:

$$SV = 0.826 * 31.745 - 26.22 = 26.22 - 26.22 = 0 \%RH$$

The same value is written in the datasheet.

7.2.3.4. Relay outputs

Relay outputs				
Relay #	Description	Pulse (seconds)	Activated from	Action on alarm/event
R1	Garage door	3.0	Phone call	Single pulse
R2	Heating	1.0	S1:TST1xx Temperat	Turn on
R3	Relay 3	1.0	SMS/HTTP API	Turn on
R4	Relay 4	1.0	SMS/HTTP API	Turn on

For every relay, a description, up to 15 characters can be set. These descriptions will appear in the monitoring page, XML/JSON data, SMS and e-mail alerts.

The pulse duration can be different for every relay. The resolution is 0.1 second, the maximum pulse value is 3600 seconds.

Both relays can be activated either remotely by SMS/single call/HTTP API or locally from the status of a monitored parameter. This setting is made from the "Activated from" drop-down menu, the possible options are:

- **SMS/HTTP** - by selecting this option the relay outputs can be activated by SMS from authorized number or by sending HTTP API commands;
- **Phone call** - by selecting this option the relay outputs can be activated (pulse only) by a single call from an authorized number.

For local activation, alarm conditions for different sources are used. They are set up in section “Setup->Conditions”. To assign a parameter to the relay, following choices are possible:

- **S?** – “S” stands for “Sensor 1-Wire”. The relay is activated from the value measured from specified 1-Wire sensor and rules for ranges specified in “Setup->Conditions”. Question mark masks a number from 1 to 8;
- **Analog input?**. The relay is activated from the value measured by specified analog input and rules for ranges specified in “Setup->Conditions”. Question mark masks a number from 1 to 4;
- **Digital input?**. The relay follows the state of the specified digital input. Question mark masks a number from 1 to 2;

All changes in above sections are saved by pressing the “Save” button.

7.2.4. Conditions

This section is used for parameterization of a trigger and alert conditions for sensors, analog, and digital inputs.

7.2.4.1. Sensors and analog inputs

Sensors							If out of range		
#	Description	Type	Parameter	Min.	Max.	Hys.	mail	sms	post
1	S1:TST1xx	1W	Temperature, °C	-40.0	85.0	8.5	<input checked="" type="checkbox"/>	<input checked="" type="checkbox"/>	<input type="checkbox"/>
			---	---	---	---	<input type="checkbox"/>	<input type="checkbox"/>	<input type="checkbox"/>
2	S2	MB	Temperature, °C	-40.0	85.0	8.5	<input type="checkbox"/>	<input type="checkbox"/>	<input type="checkbox"/>
			Humidity, %RH	0.0	100.0	10.0	<input type="checkbox"/>	<input type="checkbox"/>	<input type="checkbox"/>
3	S3	MB	Temperature, °C	-40.0	85.0	8.5	<input type="checkbox"/>	<input type="checkbox"/>	<input type="checkbox"/>
			Humidity, %RH	0.0	100.0	10.0	<input type="checkbox"/>	<input type="checkbox"/>	<input type="checkbox"/>
4	S4	MB	Temperature, °C	-40.0	85.0	8.5	<input type="checkbox"/>	<input type="checkbox"/>	<input type="checkbox"/>
			---	---	---	---	<input type="checkbox"/>	<input type="checkbox"/>	<input type="checkbox"/>
5	S5	MB	Temperature, °C	-40.0	85.0	8.5	<input type="checkbox"/>	<input type="checkbox"/>	<input type="checkbox"/>
			Humidity, %RH	0.0	100.0	10.0	<input type="checkbox"/>	<input type="checkbox"/>	<input type="checkbox"/>
6	S6	MB	---	---	---	---	<input type="checkbox"/>	<input type="checkbox"/>	<input type="checkbox"/>
			---	---	---	---	<input type="checkbox"/>	<input type="checkbox"/>	<input type="checkbox"/>
7	S7	MB	---	---	---	---	<input type="checkbox"/>	<input type="checkbox"/>	<input type="checkbox"/>
			---	---	---	---	<input type="checkbox"/>	<input type="checkbox"/>	<input type="checkbox"/>
8	S8	MB	---	---	---	---	<input type="checkbox"/>	<input type="checkbox"/>	<input type="checkbox"/>
			---	---	---	---	<input type="checkbox"/>	<input type="checkbox"/>	<input type="checkbox"/>
Return notification			<input type="checkbox"/>	Notification delay (seconds)			0	(0-3600)	

Analog inputs						If out of range			
#	Description	Dimension	Min.	Max.	Hys.	mail	sms	post	
1	Battery	VDC	4.500	6.000	0.100	<input checked="" type="checkbox"/>	<input type="checkbox"/>	<input type="checkbox"/>	
2	Sensor	kg	0.000	5.000	0.100	<input checked="" type="checkbox"/>	<input checked="" type="checkbox"/>	<input type="checkbox"/>	
3	Tank level	mBar	0.000	1000.000	1.000	<input checked="" type="checkbox"/>	<input checked="" type="checkbox"/>	<input checked="" type="checkbox"/>	
4	Analog Input 4	V	0.000	10.000	1.000	<input type="checkbox"/>	<input type="checkbox"/>	<input type="checkbox"/>	
Return notification			<input type="checkbox"/>	Notification delay (seconds)			0	(0-3600)	

For every sensor two type of fields are presented – one for the trigger conditions (“Min”, “Max” and “Hys.”) and another one for the wanted action.

“Min” and “Max” indicate the border of working range for the monitored parameter. A “Max” trigger condition occurs when the value exceeds the trigger set point. A “Min” trigger condition

occurs when the value is lower than the trigger set point. In both cases, the monitored parameter goes out of range.

Coming back in range for the observed parameter is considered when the value goes higher than (Min + Hys) or lower than (Max – Hys). Hysteresis (“Hys”) is used to prevent from excessively triggering when the value fluctuates around the trigger point.

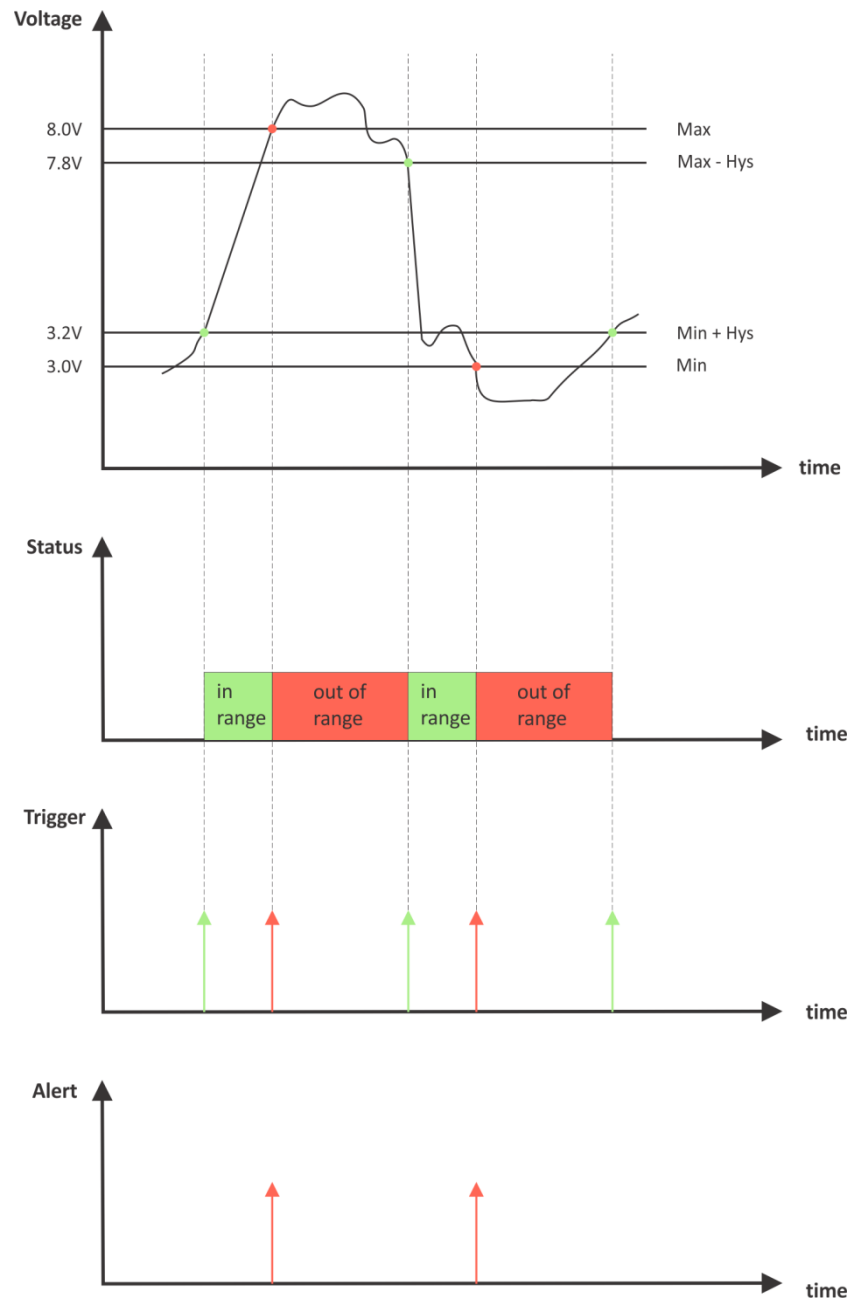

Example:

TCG140, TST100, and appropriate heater are used to control the room temperature. The wanted minimum temperature is 19°C. The initial temperature is 17°C.

TST100 is assigned on the first position for 1-Wire sensors.

For Relay1 local activation from Sensor1 is set.

Following parameters are set for Sensor1: Min=19, Max=100 and Hys=0.5.

#	Description	Type	Parameter	Min.	Max.	Hys.	mail	sms	post
1	S1:TST1xx	1W	Temperature, °C	19.0	100.0	0.5	<input checked="" type="checkbox"/>	<input checked="" type="checkbox"/>	<input type="checkbox"/>
			---	---	---	---	<input type="checkbox"/>	<input type="checkbox"/>	<input type="checkbox"/>

When the controller is switched on, Relay1 is immediately activated because the monitored temperature is out of range. This switches the heater on. The temperature is going higher.

When temperature reaches 19.5°C (19.0 + 0.5) it goes in range (trigger condition) and Relay1 is deactivated. The heater is switched off.

The temperature falls and when it reached 19°C it goes out of range (trigger and alert conditions). The relay is activated (heater is switched on) and e-mail is sent.

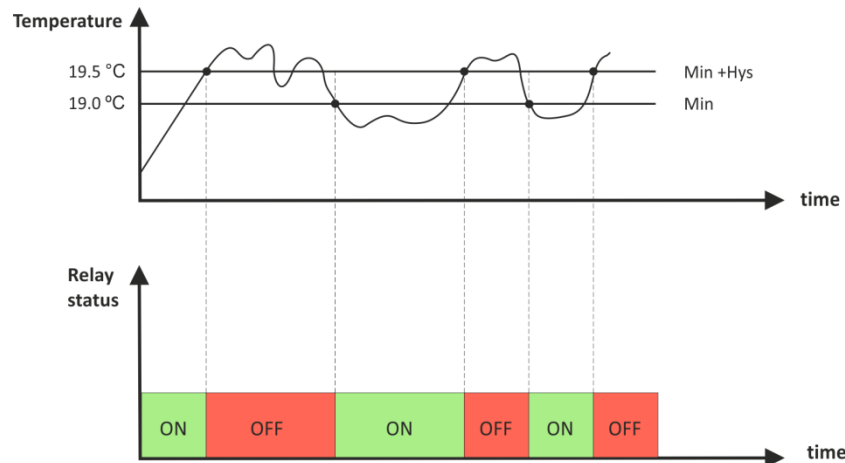

The “Max” value is set far enough from the wanted temperature to avoid trigger/alert conditions around it.

For every sensor or analog input, there are 3 independent ways of alert when there is an alarm condition – email, SMS, and post (HTTP post with XML/JSON file). Each alarm notification method is activated by a checkbox.

Globally for all sensors and for all analog inputs, there is a checkbox “Return notification”. If this option is chosen there will be notification also when parameter returns in range.

Globally for all sensors and for all analog inputs, there is a “Notification delay” parameter. It is very useful like a filter for short alarm conditions.

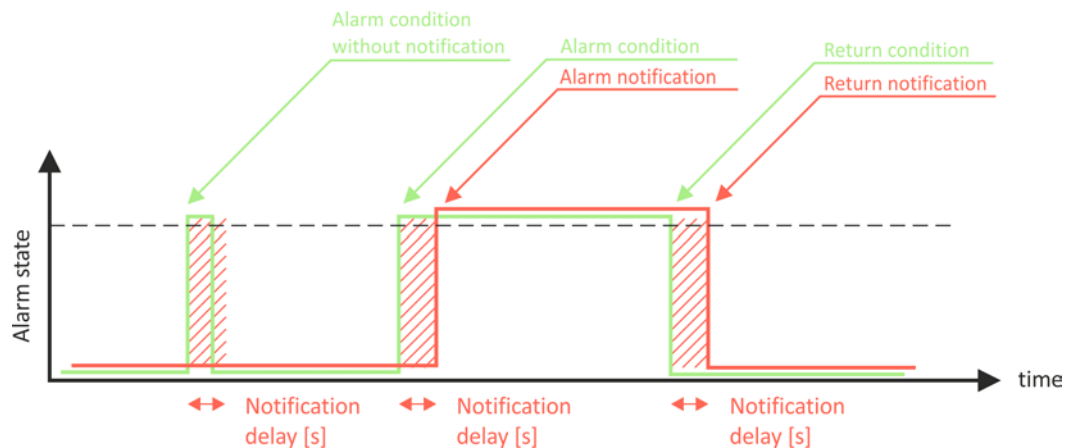

7.2.4.2. Digital inputs

Digital inputs						On active alarm		
#	Description	Current state	Select alarm state	Low to high delay	High to low delay	mail	sms	post
1	Door	OPEN	CLOSED ▼	0.0 (0-3600)	0.0 (0-3600)	<input checked="" type="checkbox"/>	<input checked="" type="checkbox"/>	<input type="checkbox"/>
2	Fuel	Full	Empty ▼	0.0 (0-3600)	0.0 (0-3600)	<input checked="" type="checkbox"/>	<input type="checkbox"/>	<input type="checkbox"/>
Return notification		<input type="checkbox"/>		Notification delay (seconds)		0 (0-3600)		

For every digital input, the alarm state should be chosen – Open or Close.

When the input goes in alarm state 3 independent way of alert are possible – email, SMS, and post (HTTP post with XML/JSON file). Each alarm notification method is activated by a checkbox.

Globally for all digital inputs, there is a checkbox “Return notification”. If this option is chosen there will be notification also when parameter returns in range.

Globally for all digital inputs, there is a “Notification delay” parameter. It is very useful like a filter for short alarm conditions.

In the time when the input is in an alarm state, on „Monitoring page“, the appropriate input will be colored in red.

There are two delays - low-to-high and high-to-low for digital input change. These delays are added to the standard delay of 30ms. They have 0.1-second resolution and by default are zero.

These options can be used for additional filtering.

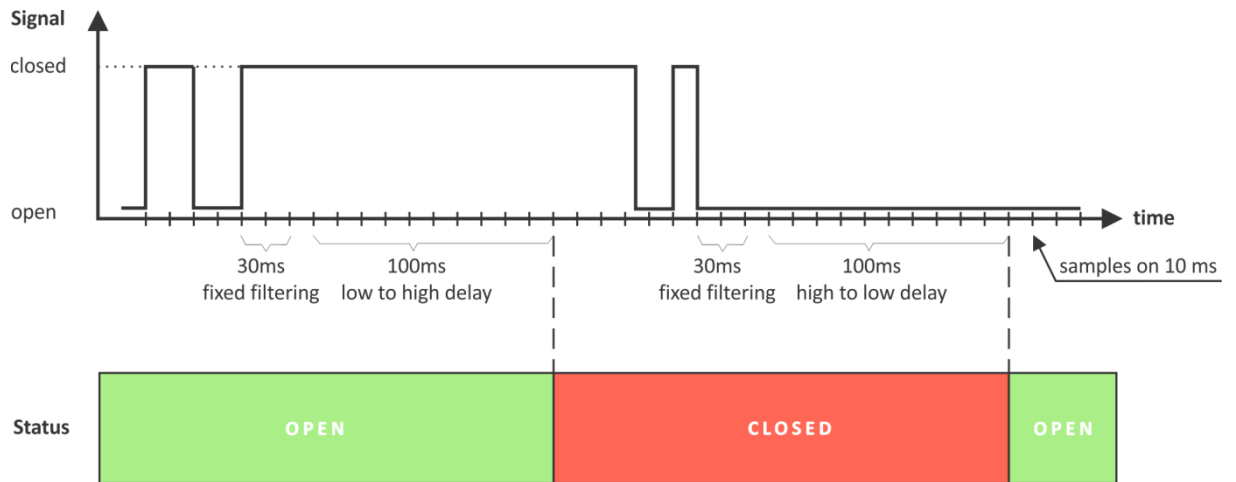

On the picture above low-to-high and high-to-low delays are set to 0.1 seconds.

7.2.5. System

The page for some general settings.

7.2.5.1. System status

System status			
GSM connection	Yes	Data in roaming	<input type="checkbox"/>
GPRS connection	Yes	GPRS in roaming	No
Signal strenght	-59dBm(87%)	Service	1
Service provider	Mobilitel EAD	IP address	10.65.198.129
Mobile Country Code(MCC)	284	Location Area Code(LAC)	28200
Mobile Network Code(MNC)	01	Cell ID(CID)	38212
IMEI	868597031584408	GSM FW version	M95FAR02A08

There is information about the general status of the controller here.

The only possible setting here is “Data in roaming” checkbox. By default, it is disabled to avoid extra charges for data transfer in roaming.

If you are using another operator's card, you must activate “Data in roaming”. Otherwise, you will not be able to use all GPRS services – emails, HTTP Post, NTP, etc.

7.2.5.2. GPRS setup

GPRS Setup	
APN	<input type="text" value="internet"/>
Username	<input type="text"/>
Password	<input type="text"/>

To set the GPRS connection it is necessary to enter the APN (Access Point Name). This setting can be different for each mobile operator. By default, it is set to “internet”. Some mobile operators may require also username and password.

7.2.5.3. Mobile network connection reset

For areas with low signal strength or where the mobile network frequently drop/block, automatic restarting of the network connection can be used. This could prevent permanently losing the connection with the device.

The automatic restart will be done once per day.

By default, the automatic restart is disabled.

Mobile network connection reset	
Automatic network connection reset	Disable
Time of the reset(hh:mm:ss)	00:00:00

7.2.5.4. General setup

General setup			
Temperature units	Celsius	1-Wire sensors	<input checked="" type="checkbox"/>
Pressure units	hPa	Modbus sensors	<input checked="" type="checkbox"/>
Host name	TCG140	Analog inputs	<input checked="" type="checkbox"/>
Writing mode	left-to-right	Digital inputs	<input checked="" type="checkbox"/>
System name	TCG140	Relay outputs	<input checked="" type="checkbox"/>
System location	Location		
System contact	info@teracomsystems.com		

The section for some general settings.

The temperature and pressure units can be changed with preferable ones.

Writing mode change the alignment in the WEB interface and SMS.

Hostname, System name, System location, and System contact are sent in XML/JSON files and can be used for flexible identification of the device. These parameters can be also included in the body of the e-mails.

The checkboxes on the right define what to see on the “Monitoring page”. By default, they all are enabled.

7.2.5.5. Device restart

In this section there are tools for full device restart and reset to factory default settings.

Device restart	
<input type="button" value="Reset to default"/>	<input type="button" value="Device restart"/>

7.2.6. NTP

Time setup	
Time configuration	NTP server
NTP server IP/URL	time.google.com:123
Time zone	+02:00
Interval (h)	12
If not found (h)	1
Set time	06.03.2018,16:19:54
Uptime	
Uptime	0days,00:10:02
<input type="button" value="Save and synchronize"/>	
Current time	06.03.2018,16:20:04
Last updated	06.03.2018,16:19:59
Status	OK

Internal RTC (real-time clock) of the controller can be set either manually or automatically.

For automatic clock synchronization, the controller supports NTP (Network Time Protocol) and all necessary parameters for automatic synchronization are available in this section.

The clock synchronization is made on “Interval” time. If the attempt was not successful, the next synchronization will be on “If not found” time.

Pressing the “Save and synchronize” button initiate time synchronization. The information for “Status” in the blue box is very useful for the availability of time server and Internet at all.

The current system time is sent in XML/JSON file when HTTP Post is enabled.

By default, NTP synchronization is disabled, server – time.google.com:123, Timezone 00.00 and interval of 12 hours.

7.2.7. Geolocation

The page contains information about MCC, MNC, LAC, CID, and RSSI for the serving cell and up to 6 neighboring cells.

Geolocation information							
	Serving Cell	Neighboring Cell 1	Neighboring Cell 2	Neighboring Cell 3	Neighboring Cell 4	Neighboring Cell 5	Neighboring Cell 6
MCC	284	284	284	284	284	284	284
MNC	01	01	01	01	01	01	01
LAC	28200	28200	28200	28200	28200	28200	28200
CID	38212	38208	38449	38214	38450	38159	38207
Signal strenght, dBm	-59	-63	-64	-71	-75	-76	-82

7.3. Services

7.3.1. SMTP

This page is used to enter valid SMTP settings for email alerts and recipients’ addresses.

7.3.1.1. SMTP setup

SMTP setup	
Mail server IP/URL	<input type="text" value="smtp.gmail.com"/>
Mail server port	<input type="text" value="465"/>
Type of encrypted connection	<input type="text" value="TLS"/>
Sender e-mail	<input type="text" value="tcw.test.mail@gmail.com"/>
Username	<input type="text" value="tcw.test.mail@gmail.com"/>
Password	<input type="password" value="*****"/>
<input type="button" value="Test server settings"/>	

Mail server address can be set either by hostname (smtp.gmail.com) or IP address.

The e-mails can be sent with or without an encrypted connection.

The default SMTP port without encryption is 25. Almost all ISP’s block this port to avoid hacker’s attacks. Ask your ISP for details.

The only supported method for encrypted connection from most of the public email servers is TLS. TCG140 supports TLS 1.0, TLS 1.1 and TLS 1.2 with RSA_WITH_AES_128_GCM_SHA256 and RSA_WITH_AES_128_CBC_SHA cipher suites. This ensures successful operation with almost all public servers.

Be careful with the terms SSL, TLS, and STARTTLS used in email server settings, supplied by the provider. Some providers as Gmail uses SSL instead of TLS and TLS instead of STARTTLS. This can provoke mismatches with the port number. The right settings for Gmail for the field “Mail server port” is 465.

Sender e-mail, username, and password are standard authentication details. For the most SMTP servers, sender's e-mail and username are the same.

There is a button for server settings test with a feedback. In this test sender and recipient of the e-mail is the same.

7.3.1.2. Alarm destination

Alarm destinations		
Recipient e-mail	<input type="text" value="JohnSmith@gmail.com"/>	<input checked="" type="checkbox"/>
Recipient e-mail	<input type="text" value="test@gmail.com"/>	<input checked="" type="checkbox"/>
Recipient e-mail	<input type="text"/>	<input type="checkbox"/>
Recipient e-mail	<input type="text"/>	<input type="checkbox"/>
Recipient e-mail	<input type="text"/>	<input type="checkbox"/>

Up to 5 email recipients can be set. Every recipient can be activated independently by a checkbox.

7.3.1.3. E-mail details

Email details	
Subject	<input type="text" value="Att. to #C"/>
Body header	<input type="text" value="From #N, located at #L"/>
Body	<input type="text" value="#S,#D=#V#U in #T"/>
Body footer	<input type="text" value="IP Address:#A, MAC Address:#M"/>
Subject, Header and Footer Variables	Body Variables
#N System Name	#D Sensor Description
#L System Location	#V Measured Value
#C System Contact	#U Unit of measured value
#A IP Address of device	#T Time stamp of message
#M MAC address of device	#S Status of parameter-ALARM/NORMAL
#H Host Name	#I ID of message
	#W LoW limit
	#G HiGh limit

The subject, body header, body and body footer can be customized. For this customization, a set of keys is used. All they are described on the page.

7.3.2. Logger

Logger setup	
Logger	<input type="text" value="Enable"/>
Logger mode	<input type="text" value="Time mode"/>
Logger record sync	<input type="text" value="Enable"/>
Log interval (seconds)	<input type="text" value="60"/> (10-3600)
Sync to the minute	<input type="text" value="0"/> (00-59)
Log interval (minutes)	<input type="text" value="15"/>
HTTP upload setup	
HTTP upload	<input type="text" value="Enable"/>
Server	http:// <input type="text" value="www.teracomsystems.com/temp/posttest.php"/>
Upload interval (h)	<input type="text" value="1h"/>
Sync time	<input type="text" value="00:00:00"/>
<input type="button" value="Upload test log"/>	
<input type="button" value="Force upload"/>	
<input type="button" value="Download full log"/>	

The logger works in three modes – Time, Alarm and Time&Alarm. The mode specifies what initiates a record in the logger’s memory.

In Time mode, records are made periodically on “Log interval” time. In Alarm mode, records are made on every alarm condition. In Time&Alarm mode, a mix of both conditions for records is used.

The log interval determines the time between two log entries. It is good to remember that by reducing the log interval, we increase the resolution, but we also reduce the past period for which we have records.

The logger records can be synchronized with a specific minute in an hour. Synchronization is very useful when monitoring electricity, water, gas meters, etc. The log interval can be chosen from a

drop-down menu between 1 and 60 minutes. The field „Sync to the minute“ determines which minute of every hour is used for synchronization. Although any minute can be selected, it is better to use the default value - 00.

Example:

The current settings are:

- Current time = 09:12
- Logger record sync = Enable;
- Sync to the minute = 00;
- Sync interval = 15 minutes.

The settings determine 4 records per hour in **HH:00**, HH:15, HH:30, and HH:45.

The device is powered up.

The first record will be immediately after power-up - 09:12. The next records will be in 09:15, 09:30, 09:45, 10:00, 10:15, etc.

There are two ways to reach the logger records:

- download of the full log file, using “Download full log” in the WEB interface;
- periodical upload the last unsent records to the dedicated HTTP server.

The records are uploaded in CSV file format. The period of the upload can be chosen from the menu between 1 and 24 hours. If you enable this service, take care of the real-time clock (NTP service).

The HTTP server for upload can be domain or IP address but take care about DNS settings.

“Sync time” is a moment in the day when a period of upload is synchronized.

Example:

Current time is 19:31, Upload period is 3 hours and Sync time is 9:00.

To synchronize the logger to 9:00 it means that time for uploads will be: 09:00, 12:00, 15:00, 18:00, 21:00, 24:00, 03:00 and 06:00. The first upload, after enabling the logger in 19:31, will be in 21:00.

The button “Force upload” initiates upload recorded information between previous periodical upload and now.

By default, the logger is disabled.

More about the logger can be found in the Data logger section.

7.3.3. HTTP Post

HTTP post setup

HTTP post: Enable

Data format: XML

Server 1: http://www.teracomsystems/temp/server1/posttest.php

Server 2: http://www.teracomsystems/temp/server2/posttest.php

Period (seconds): 300 (60-14400)

Connect on any alarm:

Key:

Process answer: No

Test Server 1

Test Server 2

HTTP Post is used for periodically upload an XML/JSON file to HTTP server by HTTP requests (POST method). The XML/JSON file contains current status of all monitored parameters and extra system information. The file format is chosen from the drop-down menu.

The HTTP servers can be addressed either by domain name or IP address.

The "Period" can be set between 60 and 14400 seconds. This parameter can be changed remotely also by HTTP API. The "Period" determines at what time the control software receives up-to-date information from TCG140 and can, therefore, make changes to some of the parameters. The shorter is "Period", the closer to the real-time operation is the system. On the other hand, as shorter is the "Period" as higher is the data traffic through the mobile network.

If the checkbox "Connect on any alarm" is selected, the HTTP Post request will be sent in an alarm condition.

The "Key" field is user defined. Its value is sent in XML/JSON file and can be used for device identification.

If "Process Answer" option is enabled, TCG140 will execute the commands, sent by the remote server as an answer of HTTP Post.

More about HTTP Post can be read in HTTP API section.

7.4. Administration

7.4.1. Backup/Restore

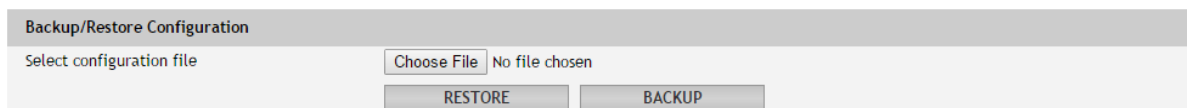

TCG140 supports backup and restore of all user setting. All settings are saved in XML backup file. This file can be used after this for restore on many devices. This is very useful for multiplying similar settings to a batch of controllers.

7.4.2. FW update

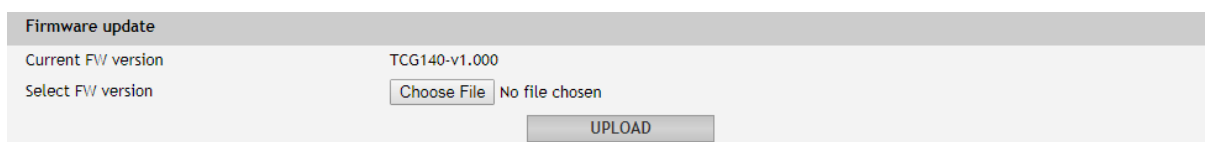

TCG140 supports firmware update over the WEB interface.

It is very simple. Download the latest firmware from www.teracomsystems.com, choose the file and press "upload" button.

Attention! Don't turn off the power supply during the update. Turning off the power supply will damage the device.

8. Setup via SMS

TCG140 supports SMS commands for parameters change and status reports, including firmware update over the air. The commands will be executed if they come from previous set 5 phone number. For every command needs different rights.

Below is a list of the supported SMS commands. Note that the underscore character "_" must be replaced by one space character.

- **Set new master number**

Rights: Master

Syntax: set_master_<number>

Where

<number> is a mobile number in the international format

Example

Command: set master +359885885885

Answer: You are the new master!

- **Set SMS users numbers** - this message is used to add/delete SMS users

Rights: Master
 Syntax: set_sms_user_<user>:<number>
 Where
 <number> is a mobile number in the international format
 <user> can be u1, u2, u3 or u4

Example

Command: set sms user u1:+359885887766
 Answer: u1:+359885887766,u2,u3,u4
 Command: set sms user u2:+359885999888
 Answer: u1:+359885887766, u2:+359885999888,u3,u4
 Command: set sms user u1:
 Answer: u1, u2:+359885999888,u3,u4

- **Display SMS users numbers**

Rights: Master, Users
 Syntax: display_sms_users

Example

Command: display sms users
 Answer: m:+359885885885,u1:+359885887766,u2:+359885999888,u3,u4

- **Set email users** - this message is used to add/delete email users

Rights: Master
 Syntax: set_email_user_<user>:<email>
 Where
 <email> - a valid email address
 <user> can be e1, e2, e3, e4 or e5

Example

Command: set email user e1:mail1@teracomsystems.com
 Answer: e1:mail1@teracomsystems.com
 Command: set email user e2:mail2@teracomsystems.com
 Answer: e2:mail2@teracomsystems.com
 Command: set email user e2:
 Answer: e2:

- **Display email users** - this message is used to request the email of a user

Rights: Master, Users
 Syntax: display_email_<user>
 Where
 <user> can be one of: e1, e2, e3, e4 or e5

Example

Command: display email e1
 Answer: e1:mail1@teracomsystems.com
 Command: display email e2
 Answer: e2:mail2@teracomsystems.com

- **Set call users numbers** - this message is used to add/delete call users

Rights: Master
 Syntax: set_call_user_<user>:<number>
 Where
 <number> is a mobile number in the international format
 <user> can be c1, c2, c3,c4 or c5

Example

Command: set call user c1:+359885887766
 Answer: c1:+359885887766, c2,c3,c4,c5
 Command: set call user c2:+359885999888
 Answer: c1:+359885887766,c2:+359885999888,c3,c4,c5
 Command: set call user c1:
 Answer: c1,c2:+359885999888,c3,c4,c5

- **Display call users** - this message is used to request a list of call users

Rights: Master, Users
 Syntax: display_call_users

Example

Command: display call users
 Answer: c1:+359885122112,c2:+359885322343,c3:+359885431276,
 c4:+359885128734,c5:+359888343434

- **Status of system** - requests main parameters of the device

Rights: Master, Users
 Syntax: status_system

Example

Command: status system
 Answer:
 27.06.2017,16:09:06,gprs=y,ss=80%,fw=1.00,call=2/5

- **Status of parameter** - requests status of digital input (di), analog input (ai), relay (r) and sensor(s)

Rights: Master, Users
 Syntax: status_<param>
 Where
 <param> is one of: di1, di2, ai1, ai2, ai3, ai4, r1, r2, r3, r4, s11,
 s12, s21, s22, s31, s32, s41, s42, s51, s52, s61,
 s62, s71, s72, s81, s82

Example

Command: status di1
 Answer: di1(Garage_door)=CLOSED
 Command: status s22
 Answer: s22(Office)=34.5%RH

- **Set a relay** - this message is used to switch on/off the selected relay output

Rights: Master, Users
 Syntax:set_<relay>=<state>_[option]
 Where
 <relay> is r1, r2, r3 or r4

<state> is on, off
[option] -w

Example

Command: set r1=on
Answer: r1=on,r2=off,r3=off,r4=off
Command: set r1=off
Answer: r1=off,r2=off,r3=off,r4=off
Command: set r1=off,r2=on,r3=on,r4=on
Answer: r1=off,r2=on,r3=on,r4=on
Command: set r1=on -w
Answer: no answer
Command: set r2=off,r4=off -w
Answer: no answer

- **Set pulse a relay** - this message is used to pulse the selected relay output

Rights: Master, Users
Syntax: set_<pulse relay>=<state>_[option]
Where
< pulse relay > is pl1, pl2, pl3 or pl4
<state> is on
[option] -w

Example

Command: set pl1=on
Answer: r1=on,r2=off,r3=off,r4=on
Command: set pl1=on,pl2=on,pl3=on,pl4=on
Answer: r1=on,r2=on,r3=on,r4=on

Command: set pl1=on -w
Answer: no answer
Command: set pl1=on,pl4=on -w
Answer: no answer

- **Post URL** – sets URL for HTTP Post

Rights: Master
Syntax: set_purl=<link> or set_purl2=<link>
Where
<link> is the address of remote server (domain or IP)

Example

Command: set purl=www.teracomsystems.com:8801/posttest.php
Answer: purl=www.teracomsystems.com:8801/posttest.php,post=on,
period=60
Command: set purl2=www.teracomsystems.com:8802/posttest.php
Answer: purl2=www.teracomsystems.com:8802/posttest.php,post=on,
period=60

- **Status URL** – status URL's for HTTP Post

Rights: Master, User
Syntax: status_purl or status_purl2

Example

Command: status_purl

Answer: `purl=www.teracomsystems.com:8801/posttest.php,
post=on,period=60`
Command: `status purl2`
Answer: `purl2=www.teracomsystems.com:8802/posttest.php,
post=on,period=60`

- **Post period** – sets HTTP Post period

Rights: Master
Syntax: `set_pper=<value>`
Where
<value> is a number between 60 and 14400 (seconds)

Example

Command: `set pper=120`
Answer: `post=off,period=120`

- **Post on** – sets HTTP Post on

Rights: Master
Syntax: `set_post=on`

Example

Command: `set post=on`
Answer: `post=on,period=120`

- **Post off** – sets HTTP Post off

Rights: Master
Syntax: `set post=off`

Example

Command: `set post=off`
Answer: `post=off,period=120`

- **Set a time server**

Rights: Master
Syntax: `set_ts=url:port`

Example

Command: `set ts=time.google.com:123`
Answer: `ts=time.google.com:123,tz=+02:00`

- **Set a time zone**

Rights: Master
Syntax: `set_tz=±hh:mm`

Example

Command: `set tz=+03:00`
Answer: `ts=time.google.com:123,tz=+03:00`

- **Restart** – restarts the device

Rights: Master
Syntax: restart

Example

Command: restart
Answer: Device is restarting!

- **Send test email** – a message for sending a test email to the email users

Rights: Master
Syntax: test_email

Example

Command: test email
Answer: Emails are sending!

- **Send test SMS** – a message for sending a test SMS to the authorized users

Rights: Master
Syntax: test_sms

Example

Command: test sms
Answer: This is a test SMS!

- **Update** – a message for update the device over the air (GPRS)

Rights: Master
Syntax: update_<URL>

Where

<URL> is a valid URL to public server, pointing update (.cod) file

Example

Command: update www.teracomsystems.com/docs/TCG140-v1.000-P-S.cod
Answer 1: Downloading firmware...
Answer 2: Firmware file downloaded. Updating...

Following answers are also possible in different situations:

Answer: File corrupt or wrong version!
Answer: Can't connect to server!
Answer: Download time out!
Answer: GPRS is not connected!
Answer: Connection lost!
Answer: Response timeout!
Answer: Socket error!

- **Status Mobile network connection reset**

Rights: Master, User
Syntax: status mncr

Example:

Command: status mncr
Answer: mncr=on,10:00:00

- **Set Mobile network connection reset**

Rights: Master
 Syntax: set mncr=<status>,hh:mm:ss
 Where
 <status> - “on” or “off”

Example: enable mobile network connection reset and set time

Command: set mncr=on,10:00:00

Answer: mncr=on,10:00:00

Example: disable mobile network connection reset

Command: set mncr=off

Answer: mncr=off,10:00:00

- **Set a sensor notification delay**

Rights: Master
 Syntax: set delsen=xxxx
 where
 xxxx – notification delay in seconds (0-3600)

Example:

Command: set delsen=5

Answer: delsen=5

- **Set a sensor limits**

Rights: Master
 Syntax: set lspt=**n**aaaa,**x**bbbb,**y**cccc
 where
p sensor number; valid values 1,2,3 or 4;
t parameter of the sensor; valid values 1 or 2;
n stands for “Min”
 aaaa value for limit “Min”;
x stands for “Max”
 bbbb value for limit “Max”
y stands for “Hys”
 cccc value for “Hys”.

Example: set of sensor 1 parameter 1 (temperature):

Command: set ls11=n25.0,x35.0,y1.0

Answer: ls11=n25.0,x35.0,y1.0

Command: set ls11=n31.0

Answer: ls11=n31.0,x35.0,y1.0

Example: set of sensor 1 parameter 2 (humidity):

Command: set ls12=n45.0,x60.0,y1.0

Answer: ls12=n45.0,x60.0,y1.0

9. Protocols and API

9.1. HTTP API

HTTP is a very popular protocol for implementation of remote monitoring and control SCADA systems. These systems are built on the client-server technology.

TCG140 supports client mode - HTTP Post. This makes the device compatible with all SCADA software running HTTP protocol.

9.2. HTTP Post

When this service is active, the controller periodically sends the HTTP Post to a server. This post contains an XML or JSON file with the current status of monitored parameters.

The post can be sent also on an alarm condition - as an analogy of the SNMP trap.

On every HTTP Post, the server returns command or FIN to terminate the connection.

A very important parameter in this communication is the HTTP Post period. With shorter time period the device generates more data traffic, but this keeps the information and possibility to control the device closer to "real-time".

The HTTP Post period can be changed by the server with appropriate HTTP command. This makes the communication very flexible.

9.2.1. Commands

The commands for TCG140 are sent in the answer's body of HTTP Post request. The structure of command is:

```
set yyy=xxx
```

Where:

yyy is the command;

xxx is the parameter.

Example:

```
set r1=on – will turn on the relay 1.
```

```
set FIN – will terminate the session.
```

The full list of the commands is available on 9.4.

9.2.2. Typical communication session

Below is a typical communication session between TCG140 and remote server:

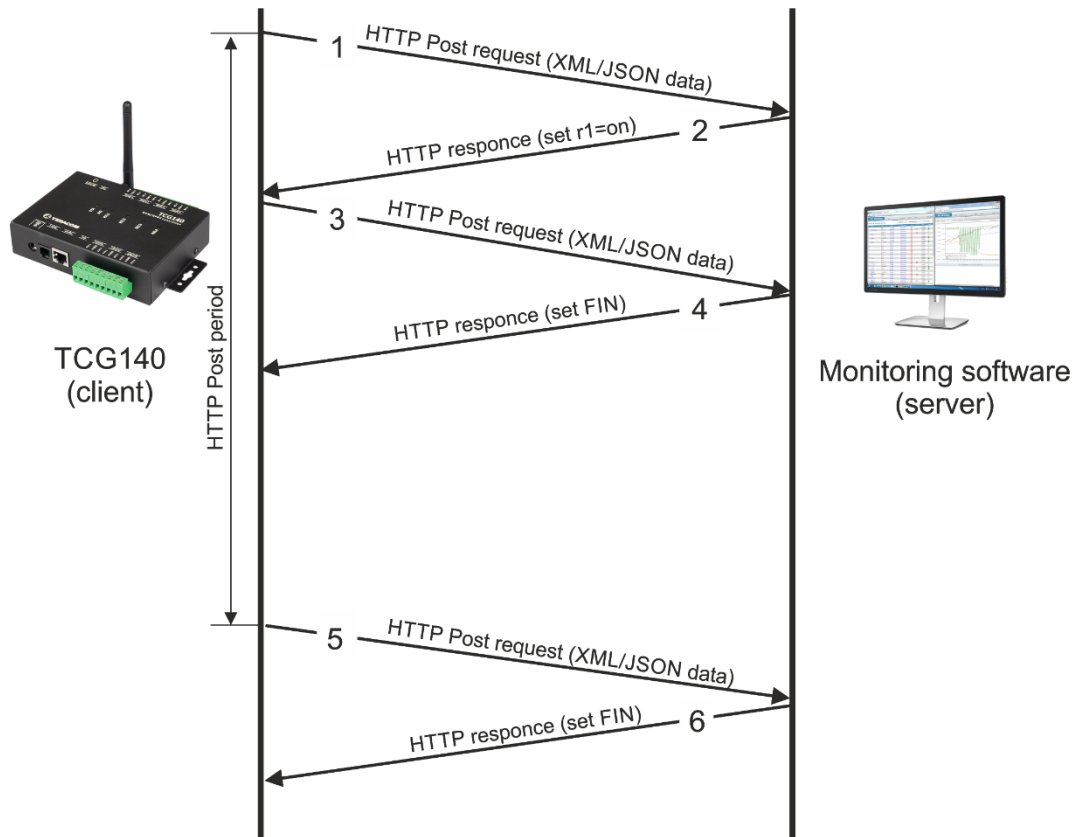

- The device sends HTTP Post request (1) with XML/JSON data to the remote server either on post period or on alarm condition;
- The server returns HTTP response (2), which contains “set r1=on” command as a brief text in the message body;
- The device sends a new HTTP Post request (3) with updated XML/JSON data, which confirms the execution of “set r1=on” command;
- The server returns a new HTTP response (4), which includes “set FIN” in the message body. This indicates that there are no pending commands and the session can be closed;
- On next HTTP Post period, TCG140 sends a new HTTP POST request (5) to the server;
- The server answers with “set FIN” (6) – there is no pending commands and the session can be closed.

A typical monitoring application is shown below:

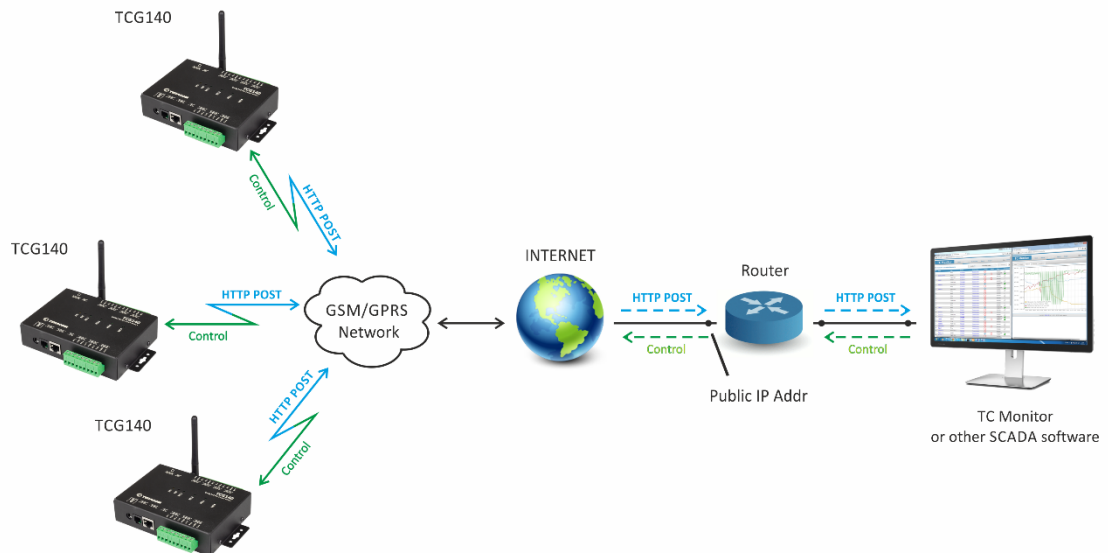

HTTP Post service can be test following the steps below:

- Save following code like post.php:

```
<?php
define("FILENAME", 'status.xml');
define("FOLDER", "");
define("SEPARATOR", "");
define("STR_SUCCESS", 'set FIN');
define("STR_ERROR", 'error');

if($_SERVER['REQUEST_METHOD'] == 'POST'){
    $datePrefix = date('YmdHis', strtotime('now'));
    $pathname = FOLDER.SEPARATOR.$datePrefix.'_' .FILENAME;
    $postdata = file_get_contents("php://input");
    $handle = fopen($pathname, 'w+');
    $content = var_export($postdata, true);
    fwrite($handle, substr($content, 1, strlen($content)-2));
    fclose($handle);
    echo (($handle === false) ? STR_ERROR : STR_SUCCESS)."\r\n";
}
else {
    echo "The PHP script is working!";
}
?>
```

- Copy the *post.php* file on a WEB server with PHP support. The server should have visibility from the Internet. The UniServer and XAMP are the most popular WEB servers for Windows.
- To verify that the script is working properly, type the URL (for example www.yourserverURL.com/post.php) in the WEB browser. If all is OK, a WEB page with “The PHP script is working!” will be shown.
- Activate HTTP Post service, setting www.yourserverURL.com/post.php in the URL field.
- Click on “Test HTTP Post” button.
- If the HTTP POST is received and processed, “OK” will be shown close to the button. Along with this, an XML file will be created in the same directory, where *post.php* is located. The file name will contain time information and looks as 20171020103318_status.xml.

9.3. List of HTTP API commands

TCG140 supports following HTTP commands, they are case sensitive:

Command	Description
rn=xxx	Turn relay n ON (xxx=on) or OFF (xxx=off) (n is 1,2,3 or 4 for the respective relay) r2=on - will turn ON relay 2 r4=off – will turn OFF relay 4
r1=on&r2=on&r3=on&r4=on	Turn four relays ON
r1=off&r2=off&r3=off&r4=off	Turn four relays OFF
rn=tg	Toggle relay n (n is 1,2,3 or 4 for the respective relay) r2= tg – will toggle relay 2
r1=tg&r2=tg&r3=tg&r4=tg	Toggle four relays
rn=pl	Pulse relay n (n is 1,2,3 or 4 for the respective relay) r3=pl – will pulse relay 3
r1=pl&r2=pl&r3=pl&r4=pl	Pulse four relays
vnf=10.0	Set Min of analog input to 10.0 (f is 1,2,3 or 4 for the respective input) vn1=10.0 will set Min for analog input 1
vxv=20.0	Set Max of analog input to 20.0 (f is 1,2,3 or 4 for the respective input) vx2=20.0 will set Max for analog input 2
vyf=1.0	Set Hys of analog input to 1.0 (f is 1,2,3 or 4 for the respective input) vy4=1.0 will set Hys for analog input 4
snpt=30.0	Set Min of sensor to 30.0 (p is 1,2,3,4,5,6,7 or 8 for the respective sensor t is 1 or 2 for the respective parameter of sensor) sn12=30.0 will set Min for sensor 1, parameter 2
sxpt=40.0	Set Max of sensor to 40.0 (p is 1,2,3,4,5,6,7 or 8 for the respective sensor t is 1 or 2 for the respective parameter of sensor) sx42=40.0 will set Min for sensor 4, parameter 2
sypt=2.0	Set Hys of sensor to 2.0 (p is 1,2,3,4,5,6,7 or 8 for the respective sensor t is 1 or 2 for the respective parameter of sensor) sy81=2.0 will set Hys for sensor 8, parameter 1
delsen=xxxx	Notification delay for sensors (xxxx is between 0 and 3600)
delanl=xxxx	Notification delay for analog inputs (xxxx is between 0 and 3600)
deldig=xxxx	Notification delay for digital inputs (xxxx is between 0 and 3600)
dda1=xxxx	Low to high delay for digital input 1 (xxxx is between 0 and 3600)
ddd1=xxxx	High to low delay for digital input 1 (xxxx is between 0 and 3600)

dda2=xxxx	Low to high delay for digital input 2 (xxxx is between 0 and 3600)
ddd2=xxxx	High to low delay for digital input 2 (xxxx is between 0 and 3600)
pmet=x	Enable/disable HTTP Post - 0 disable, 1 enable
dataf=x	Data format XML/JSON for HHTTP Post – 0 XML, 1 JSON
purl=yyy	URL for HTTP Post to Server 1, where yyy is a full path to php file Example: purl=212.25.45.120:30181/xampp/test/pushtest.php
purl2=yyy	URL for HTTP Post to Server 2, where yyy is a full path to php file Example: purl=212.25.45.120:30181/xampp/test/pushtest.php
pper=x	HTTP Post period in seconds (x is between 60 and 14400)
dk=xxx	HTTP Post key – xxx is up to 17 characters
pans=x	HTTP Post process answer – 0 No, 1 Yes
FIN	Terminate session (it makes sense only for HTTP Post)

9.4. File structures

For XML file structure please see the Appendix A.

For JSON file structure please see the Appendix B.

9.5. MODBUS RTU

9.5.1. Communication parameters

For MODBUS RTU, TCG140 supports the following communication parameters:

- Baud rate – 2400, 4800, 9600, 19200, 38400, or 57600;
- Data bits – 8;
- Stop bits – 1 or 2;
- Parity – Odd or Even;

As factory default communication parameters the device uses standard ones for MODBUS RTU:

- Baud rate – 19200;
- Data bits – 8;
- Stop bits – 1;
- Parity – Even;

9.5.2. Teracom sensors update tool

TCG140 supports Teracom sensor FW update tool.

The tool is available at <http://device.ip.address/teracom485.htm>.

Attention! To make any changes to MODBUS RTU sensor it should be alone on the RS-485 bus.

9.5.2.1 Sensor settings

Sensor settings	
Current address	1
Sensor info	TST3xx-v2.12
ID	[3300A118A1FFFF60]
<input type="button" value="Scan"/>	

The tool works with the current MODBUS RTU communication parameters.

To avoid collisions the good practice is to set TCG140 and the sensor with the factory default MODBUS RTU communication parameters. This will ensure smooth operation. The default MODBUS RTU communication parameters for TCG140 are described in 8.5.1. Communication parameters.

Before to make any changes it is strongly recommended to scan for sensor settings. This will inform about the current FW version of the sensor but also will check if the sensor is alone on the bus.

9.5.2.2 Sensor FW update

To arrange the FW update, the appropriate file should be uploaded to the sensor first and after this, the button “Update” should be pressed.

10. Data Logger

The logger utilizes circular buffer in FLASH memory. When it is full, the new data overwrites the oldest one. In this manner FLASH memory stores full log all the time. There isn’t a command to clear the log. A copy of the full log is always available for download.

The number of records depends on how long descriptions and what kind of characters are used. In the worst case (15 bytes description with characters from the highest part of UTF-8) a number of records are about 37000. This number is enough for 25 days with records on every 1 minute.

In most of the cases, the data logger can keep 53000 records, which is enough for 36 days with records on every 1 minute.

The new records can be periodically uploaded as a file to a dedicated HTTP server in time intervals – 1, 2, 3, 4, 6, 8, 12 and 24 hours. The file is in CSV format. A semicolon is used as a delimiter.

The first row of the log file is always header. All rows, including the header, start with record ID and time stamp.

The structure of one row (record) of the log is as follows:

ID	Time	Type of record	Inputs value	Relays	Alarm conditions
----	------	----------------	--------------	--------	------------------

ID	32-bit unique number for every row (record).
Time	a time stamp of record, in format yyyy.mm.dd, hh:mm:ss.
Type of record	following types of records are available: "Time" for periodical record; "Event" for record initiated by alarm condition; "Type" for header record; "Start" after power-up condition; "Restart" after reset condition; "Power Down" after power-down condition; "Bad" for a problematic record.
Inputs value	in orders – sensors, analog inputs and digital inputs.
Relays	the relays conditions.
Alarm conditions	show condition for every input, “1” means an active alarm.

An example of the log file:

```
1131901;15.10.2017,01:02:23;Type;S11/°C;S12;S21/°C;S22;S31/°C;S32;S41/°C;S42;S51/°C;S52;S61/°C;S62;S71/°C;S72;S81/°C;S82;A1/V;A2/V;D1;D2;R1;R2;S1
1/°C;S12;S21/°C;S22;S31/°C;S32;S41/°C;S42;S51/°C;S52;S61/°C;S62;S71/°C;S72;S81/°C;S82;A1/V;A2/V;D1;D2;
1131902;15.10.2017,01:02:23;Time;18.250;;18.375;;18.125;;18.500;;18.188;;18.125;;18.375;;18.375;;11.352;0.065;1;0;1;0;1;;1;;1;;1;;1;;1;0;1;0;
1131903;15.10.2017,01:02:23;Event;18.250;;18.438;;18.125;;18.500;;18.188;;18.125;;18.313;;18.375;;11.352;0.066;0;1;0;1;1;;1;;1;;1;;1;;1;0;0;1;
1131904;15.10.2017,01:02:24;Time;18.250;;18.438;;18.125;;18.500;;18.188;;18.125;;18.313;;18.375;;11.352;0.066;0;1;0;1;1;;1;;1;;1;;1;;1;0;0;1;
1131905;15.10.2017,01:02:25;Time;18.250;;18.375;;18.125;;18.500;;18.188;;18.125;;18.313;;18.375;;11.352;0.066;0;1;0;1;1;;1;;1;;1;;1;;1;0;0;1;
1131906;15.10.2017,01:02:26;Time;18.250;;18.375;;18.125;;18.500;;18.188;;18.125;;18.313;;18.313;;11.352;0.066;0;1;0;1;1;;1;;1;;1;;1;;1;0;0;1;
1131907;15.10.2017,01:02:27;Time;18.250;;18.375;;18.125;;18.438;;18.188;;18.125;;18.313;;18.313;;11.352;0.066;0;1;0;1;1;;1;;1;;1;;1;;1;0;0;1;
1131908;15.10.2017,01:02:27;Event;18.250;;18.375;;18.125;;18.438;;18.188;;18.125;;18.313;;18.313;;2.198;9.092;0;1;0;1;1;;1;;1;;1;;1;;1;0;0;0;1;
```

11. Firmware update

TCG140 supports firmware update over the WEB interface and over the air.

For firmware update over the WEB interface please see 7.4.2. FW update.

For firmware update over the air (GPRS) please follow the steps below:

- Upload the update file (.cod extension) on public HTTP server ;
- Send firmware update command (the syntax of the SMS message is described in 8. Setup via SMS).

Please note that only the Master can send this message.

The firmware will be downloaded and verified. The download via GPRS takes around 3 minutes. If the file is correct, the Master will receive confirmation SMS message. The update procedure takes around 2 minutes. Once the firmware update is complete (about 5 minutes), TCG140 will restart.

Attention! Don't turn off the power supply during the update. Turning off the power supply will damage the device.

12. Factory default settings

TCG140 can be restored to its original factory default settings by following the steps:

- Turn off the power supply;
- Press and hold the RESET button then turn on the power supply;
- STA and SIG LEDs will turn ON;
- Release the RESET button.

The controller will restore its default settings.



13. Environment information

This equipment is intended for use in a Pollution Degree 2 environment, at altitudes up to 2000 meters. When the controller is a part of a system, the other elements of the system shall comply with the EMC requirements and shall be intended for use in the same ambient conditions.

14. Safety

This device must not be used for medical, life-saving purposes or for any purpose where its failure could cause serious injury or the loss of life.

To reduce the risk of fire, only flexible stranded wire, with cross section 0.5mm² or larger for wiring of digital and analog inputs and relay output of the device should be used.

To avoid electric shock and fire hazard, do not expose this product to liquids, rain, or moisture. Objects filled with liquids, such as vases, should not be placed on this device.

There is a risk of overheating (damage) of controller, if recommended free spaces to adjacent devices are not ensured. Joint part with external component shall have space for attachment/removal of the cable after installation.

Teracom does not guarantee successful operation of the product if the product was used under conditions deviating from the product specifications.

15. Maintenance

Upon completion of any service or repairs to the device or once per year, safety check must be performed to determine that this product is in proper operating condition. Clean the device only with dry cloth. Do not use a liquid cleaner or an aerosol cleaner. Do not use a magnetic/static cleaning device (dust remover) or any kind of abrasive materials to clean the device.

16. Package content

The box contains:

- TCG140
- GSM antenna
- Quick start guide

Appendix A

The XML file (status.xml) structure:

```
<Monitor>
  <DeviceInfo>
    <DeviceName>TCG140</DeviceName>
    <HostName> TCG140</HostName>
    <ID>862462032599374</ID>
    <FwVer>TCG140-v1.005</FwVer>
    <MnflInfo>www.teracomsystems.com</MnflInfo>
    <SysContact>info@teracomsystems.com</SysContact>
    <SysName>Name</SysName>
    <SysLocation>Location</SysLocation>
  </DeviceInfo>
  <S>
    <S1>
      <description>S1:TST1xx</description>
      <id>28C4C109030000C5</id>
      <type>1W</type>
      <addr>1Wire</addr>
      <item1>
        <value>12.7</value>
        <unit>°C</unit>
        <alarm>0</alarm>
        <min>-40.0</min>
        <max>85.0</max>
        <hyst>8.5</hyst>
      </item1>
      <item2>
        <value>---</value>
        <unit>---</unit>
        <alarm>0</alarm>
        <min>---</min>
        <max>---</max>
        <hyst>---</hyst>
      </item2>
    </S1>
    <S2>
      <description>S2</description>
      <id>15AA3168E6FFFC6</id>
      <type>MB</type>
      <addr>2</addr>
      <item1>
        <value>23.5</value>
        <unit>°C</unit>
        <alarm>0</alarm>
        <min>-40.0</min>
        <max>85.0</max>
        <hyst>8.5</hyst>
      </item1>
      <item2>
        <value>34.9</value>
        <unit>%RH</unit>
        <alarm>0</alarm>
        <min>0.0</min>
        <max>100.0</max>
        <hyst>10.0</hyst>
      </item2>
    </S2>
    <S3>
      <description>S3</description>
      <id>152DB379F9FFFF43</id>
      <type>MB</type>
      <addr>3</addr>
      <item1>
        <value>23.5</value>
        <unit>°C</unit>
```

```

        <alarm>0</alarm>
        <min>-40.0</min>
        <min>85.0</min>
        <hyst>8.5</hyst>
    </item1>
    <item2>
        <value>35.7</value>
        <unit>%RH</unit>
        <alarm>0</alarm>
        <min>0.0</min>
        <max>100.0</max>
        <hyst>10.0</hyst>
    </item2>
</S3>
<S4>
    <description>S4 </description>
    <id>3300A118A1FFFF60</id>
    <type>MB</type>
    <addr>1</addr>
    <item1>
        <value>23.2</value>
        <unit>°C</unit>
        <alarm>0</alarm>
        <min>-40.0</min>
        <max>85.0</max>
        <hyst>8.5</hyst>
    </item1>
    <item2>
        <value>57.2</value>
        <unit>%RH</unit>
        <alarm>0</alarm>
        <min>0.0</min>
        <max>100.0</max>
        <hyst>1.0</hyst>
    </item2>
</S4>
<S5>
    <description>S5</description>
    <id>0000000000000000</id>
    <type>MB</type>
    <addr>0</addr>
    <item1>
        <value>---</value>
        <unit>---</unit>
        <alarm>0</alarm>
        <min>---</min>
        <max>---</max>
        <hyst>---</hyst>
    </item1>
    <item2>
        <value>---</value>
        <unit>---</unit>
        <alarm>0</alarm>
        <min>---</min>
        <max>---</max>
        <hyst>---</hyst>
    </item2>
</S5>
<S6>
    <description>S6</description>
    <id>0000000000000000</id>
    <type>MB</type>
    <addr>0</addr>
    <item1>
        <value>---</value>
        <unit>---</unit>
        <alarm>0</alarm>
        <min>---</min>

```



```

        <max>---</max>
        <hyst>---</hyst>
    </item1>
    <item2>
        <value>---</value>
        <unit>---</unit>
        <alarm>0</alarm>
        <min>---</min>
        <max>---</max>
        <hyst>---</hyst>
    </item2>
</S6>
<S7>
    <description>S7</description>
    <id>0000000000000000</id>
    <type>MB</type>
    <addr>0</addr>
    <item1>
        <value>---</value>
        <unit>---</unit>
        <alarm>0</alarm>
        <min>---</min>
        <max>---</max>
        <hyst>---</hyst>
    </item1>
    <item2>
        <value>---</value>
        <unit>---</unit>
        <alarm>0</alarm>
        <min>---</min>
        <max>---</max>
        <hyst>---</hyst>
    </item2>
</S7>
<S8>
    <description>S8</description>
    <id>0000000000000000</id>
    <item1>
        <value>---</value>
        <unit>---</unit>
        <alarm>0</alarm>
        <min>---</min>
        <max>---</max>
        <hyst>---</hyst>
    </item1>
    <item2>
        <value>---</value>
        <unit>---</unit>
        <alarm>0</alarm>
        <min>---</min>
        <max>---</max>
        <hyst>---</hyst>
    </item2>
</S8>
</S>
<AI>
    <AI1>
        <description>Analog Input 1</description>
        <value>9.300</value>
        <unit>V</unit>
        <multiplier>1.000</multiplier>
        <offset>0.000</offset>
        <alarm>0</alarm>
        <min>0.000</min>
        <max>10.000</max>
        <hyst>0.100</hyst>
    </AI1>
    <AI2>

```

```

<description>Analog Input 2</description>
<value>4.95</value>
<unit>V</unit>
<multiplier>1.000</multiplier>
<offset>0.000</offset>
<alarm>1</alarm>
<min>0.000</min>
<max>6.000</max>
<hyst>0.100</hyst>
</AI2>
<AI3>
<description>Analog Input 3</description>
<value>0.000</value>
<unit>V</unit>
<multiplier>1.000</multiplier>
<offset>0.000</offset>
<alarm>0</alarm>
<min>0.000</min>
<max>10.000</max>
<hyst>0.100</hyst>
</AI3>
<AI4>
<description>Analog Input 4</description>
<value>0.000</value>
<unit>V</unit>
<multiplier>1.000</multiplier>
<offset>0.000</offset>
<alarm>0</alarm>
<min>0.000</min>
<max>10.000</max>
<hyst>0.100</hyst>
</AI4>
</AI>
<DI>
<DI1>
<description>Digital Input 1</description>
<value>OPEN</value>
<valuebin>1</valuebin>
<alarmState>CLOSED</alarmState>
<alarm>0</alarm>
</DI1>
<DI2>
<description>Digital Input 2</description>
<value>OPEN</value>
<valuebin>1</valuebin>
<alarmState>CLOSED</alarmState>
<alarm>0</alarm>
</DI2>
</DI>
<R>
<R1>
<description>Relay 1</description>
<value>OFF</value>
<valuebin>0</valuebin>
<pulseWidth>1</pulseWidth>
<control>S1:TST1xx Temperature</control>
</R1>
<R2>
<description>Relay 2</description>
<value>OFF</value>
<valuebin>0</valuebin>
<pulseWidth>1</pulseWidth>
<control>0</control>
</R2>
<R3>
<description>Relay 3</description>
<value>OFF</value>
<valuebin>0</valuebin>

```

```

        <pulseWidth>1</pulseWidth>
        <control>0</control>
    </R3>
    <R4>
        <description>Relay 4</description>
        <value>OFF</value>
        <valuebin>0</valuebin>
        <pulseWidth>1</pulseWidth>
        <control>0</control>
    </R4>
</R>
<HTTPPush>
    <Key/>
    <PushPeriod>300</PushPeriod>
</HTTPPush>
<signalpercent>80</signalpercent>
<hwerr/>
<Alarmed>1</Alarmed>
<Scannig/>
<Time>
    <Date>29.01.2019</Date>
    <Time>09:41:14</Time>
</Time>
<NetworkInfo>
    <Name>Mobitel EAD</Name>
    <SC>
        <MCC>284</MCC>
        <MNC>01</MNC>
        <LAC>28200</LAC>
        <CID>38212</CID>
        <SQ>-57</SQ>
    </SC>
    <NC1>
        <MCC>284</MCC>
        <MNC>01</MNC>
        <LAC>28200</LAC>
        <CID>38208</CID>
        <SQ>-60</SQ>
    </NC1>
    <NC2>
        <MCC>284</MCC>
        <MNC>01</MNC>
        <LAC>28200</LAC>
        <CID>38449</CID>
        <SQ>-63</SQ>
    </NC2>
    <NC3>
        <MCC>284</MCC>
        <MNC>01</MNC>
        <LAC>28200</LAC>
        <CID>38214</CID>
        <SQ>-70</SQ>
    </NC3>
    <NC4>
        <MCC>284</MCC>
        <MNC>01</MNC>
        <LAC>28200</LAC>
        <CID>38159</CID>
        <SQ>-75</SQ>
    </NC4>
    <NC5>
        <MCC>284</MCC>
        <MNC>01</MNC>
        <LAC>28200</LAC>
        <CID>38450</CID>
        <SQ>-76</SQ>
    </NC5>
</NC6>

```

```
<MCC>284</MCC>  
<MNC>01</MNC>  
<LAC>28200</LAC>  
<CID>38213</CID>  
<SQ>-78</SQ>  
</NC6>  
<NetworkInfo>  
</Monitor>
```

Where:

*<value>--- </value> and <unit>--- </unit> means no 1-Wire sensor on this position;
<alarm>1</alarm> means there is a trigger condition.*

The JSON file (status.json)structure:

```
{
  "Monitor": {
    "DeviceInfo": {
      "DeviceName": "TCG140",
      "HostName": " TCG140",
      "ID": "862462032599374",
      "FwVer": " TCG140-v1.005",
      "Mnflnfo": "www.teracomsystems.com",
      "SysContact": "info@teracomsystems.com",
      "SysName": "Name",
      "SysLocation": "Location"
    },
    "S": {
      "S1": {
        "description": "S1:TST1xx",
        "id": "28C4C109030000C5",
        "type": "1W",
        "addr": "1Wire",
        "item1": {
          "value": "14.9",
          "unit": "B°C",
          "alarm": "0",
          "min": "-40.0",
          "max": "85.0",
          "hyst": "8.5"
        },
        "item2": {
          "value": "---",
          "unit": "---",
          "alarm": "0",
          "min": "---",
          "max": "---",
          "hyst": "---"
        }
      },
      "S2": {
        "description": "S2",
        "id": "15AA3168E6FFFFC6",
        "type": "MB",
        "addr": "2",
        "item1": {
          "value": "23.7",
          "unit": "°C",
          "alarm": "0",
          "min": "-40.0",
          "max": "85.0",
          "hyst": "8.5"
        },
        "item2": {
          "value": "34.2",
          "unit": "%RH",
          "alarm": "0",
          "min": "0.0",
          "max": "100.0",
          "hys": "10.0"
        }
      },
      "S3": {
        "description": "S3",
        "id": "152DB379F9FFFF43",
        "type": "MB",
        "addr": "3",
        "item1": {
```

```

        "value": "23.1",
        "unit": "°C",
        "alarm": "0",
        "min": "-40.0",
        "max": "85.0",
        "hys": "8.5"
    },
    "item2": {
        "value": "35.9",
        "unit": "%RH",
        "alarm": "0",
        "min": "0.0",
        "max": "100.0",
        "hys": "10.0"
    }
},
"S4": {
    "description": "S4",
    "id": "3300A118A1FFFF60",
    "type": "MB",
    "addr": "1",
    "item1": {
        "value": "22.9",
        "unit": "°C",
        "alarm": "0",
        "min": "-40.0",
        "max": "85.0",
        "hys": "8.5"
    },
    "item2": {
        "value": "---",
        "unit": "---",
        "alarm": "0",
        "min": "---",
        "max": "---",
        "hys": "---"
    }
},
"S5": {
    "description": "S5",
    "id": "0000000000000000",
    "type": "MB",
    "addr": "0",
    "item1": {
        "value": "---",
        "unit": "---",
        "alarm": "0",
        "min": "---",
        "max": "---",
        "hyst": "---"
    },
    "item2": {
        "value": "---",
        "unit": "---",
        "alarm": "0",
        "min": "---",
        "max": "---",
        "hyst": "---"
    }
},
"S6": {
    "description": "S6",
    "id": "0000000000000000",
    "type": "MB",
    "addr": "0",
    "item1": {
        "value": "---",
        "unit": "---",

```

```

        "alarm": "0",
        "min": "---",
        "max": "---",
        "hyst": "---"
    },
    "item2": {
        "value": "---",
        "unit": "---",
        "alarm": "0",
        "min": "---",
        "max": "---",
        "hyst": "---"
    }
},
"S7": {
    "description": "S7",
    "id": "0000000000000000",
    "type": "MB",
    "addr": "0",
    "item1": {
        "value": "---",
        "unit": "---",
        "alarm": "0",
        "min": "---",
        "max": "---",
        "hyst": "---"
    },
    "item2": {
        "value": "---",
        "unit": "---",
        "alarm": "0",
        "min": "---",
        "max": "---",
        "hyst": "---"
    }
},
"S8": {
    "description": "S8",
    "id": "0000000000000000",
    "type": "MB",
    "addr": "0",
    "item1": {
        "value": "---",
        "unit": "---",
        "alarm": "0",
        "min": "---",
        "max": "---",
        "hyst": "---"
    },
    "item2": {
        "value": "---",
        "unit": "---",
        "alarm": "0",
        "min": "---",
        "max": "---",
        "hyst": "---"
    }
},
"AI": {
    "AI1": {
        "description": "Analog Input 1",
        "value": "9.300",
        "unit": "V",
        "multiplier": "1.000",
        "offset": "0.000",
        "alarm": "0",

```



```

        "min": "0.000",
        "max": "9.500",
        "hyst": "0.100"
    },
    "AI2": {
        "description": "Analog Input 2",
        "value": "4.950",
        "unit": "V",
        "multiplier": "1.000",
        "offset": "0.000",
        "alarm": "1",
        "min": "4.500",
        "max": "6.000",
        "hyst": "0.100"
    },
    "AI3": {
        "description": "Analog Input 3",
        "value": "0.000",
        "unit": "V",
        "multiplier": "1.000",
        "offset": "0.000",
        "alarm": "1",
        "min": "0.000",
        "max": "10.000",
        "hyst": "1.000"
    },
    "AI4": {
        "description": "Analog Input 4",
        "value": "0.000",
        "unit": "V",
        "multiplier": "1.000",
        "offset": "0.000",
        "alarm": "1",
        "min": "0.000",
        "max": "10.000",
        "hyst": "1.000"
    }
},
"DI": {
    "DI1": {
        "description": "Digital Input 1",
        "value": "OPEN",
        "valuebin": "1",
        "alarmState": "CLOSED",
        "alarm": "0"
    },
    "DI2": {
        "description": "Digital Input 2",
        "value": "OPEN",
        "valuebin": "1",
        "alarmState": "CLOSED",
        "alarm": "0"
    }
},
"R": {
    "R1": {
        "description": "Relay 1",
        "value": "OFF",
        "valuebin": "0",
        "pulseWidth": "1",
        "control": "S1:TST1xx Temperature"
    },
    "R2": {
        "description": "Relay 2",
        "value": "OFF",
        "valuebin": "0",
        "pulseWidth": "1",
        "control": "0"
    }
}

```

```

    },
    "R3": {
      "description": "Relay 3",
      "value": "OFF",
      "valuebin": "0",
      "pulseWidth": "1",
      "control": "0"
    },
    "R4": {
      "description": "Relay 4",
      "value": "OFF",
      "valuebin": "0",
      "pulseWidth": "1",
      "control": "0"
    }
  },
  "HTTTPush": {
    "Key": "",
    "PushPeriod": "300"
  },
  "signalpercent": "80",
  "hwerr": "",
  "Alarmed": "1",
  "Scannig": "",
  "Time": {
    "Date": "29.01.2019",
    "Time": "09:05:52"
  },
  "NetworkInfo": {
    "Name": "Mobilitel EAD",
    "SC": {
      "MCC": "284",
      "MNC": "01",
      "LAC": "28200",
      "CID": "38208",
      "SQ": "-53"
    },
    "NC1": {
      "MCC": "284",
      "MNC": "01",
      "LAC": "28200",
      "CID": "38212",
      "SQ": "-62"
    },
    "NC2": {
      "MCC": "284",
      "MNC": "01",
      "LAC": "28200",
      "CID": "38449",
      "SQ": "-68"
    },
    "NC3": {
      "MCC": "284",
      "MNC": "01",
      "LAC": "28200",
      "CID": "38214",
      "SQ": "-70"
    },
    "NC4": {
      "MCC": "284",
      "MNC": "01",
      "LAC": "28200",
      "CID": "38159",
      "SQ": "-78"
    },
    "NC5": {
      "MCC": "284",
      "MNC": "01",

```

```
"LAC": "28200",  
"CID": "38450",  
"SQ": "-78"  
},  
"NC6": {  
  "MCC": "284",  
  "MNC": "01",  
  "LAC": "28200",  
  "CID": "38207",  
  "SQ": "-82"  
}  
}  
}  
}
```

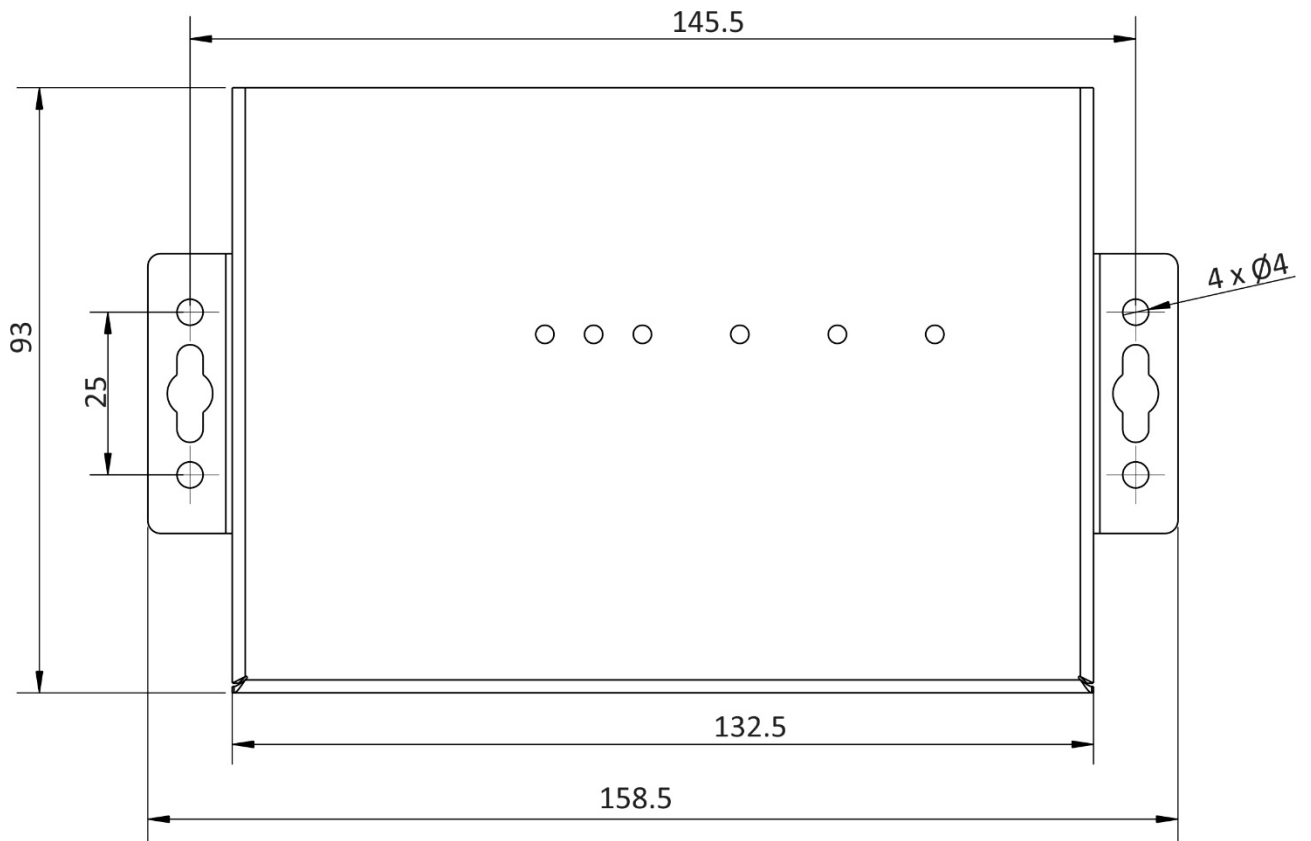

Fig.1

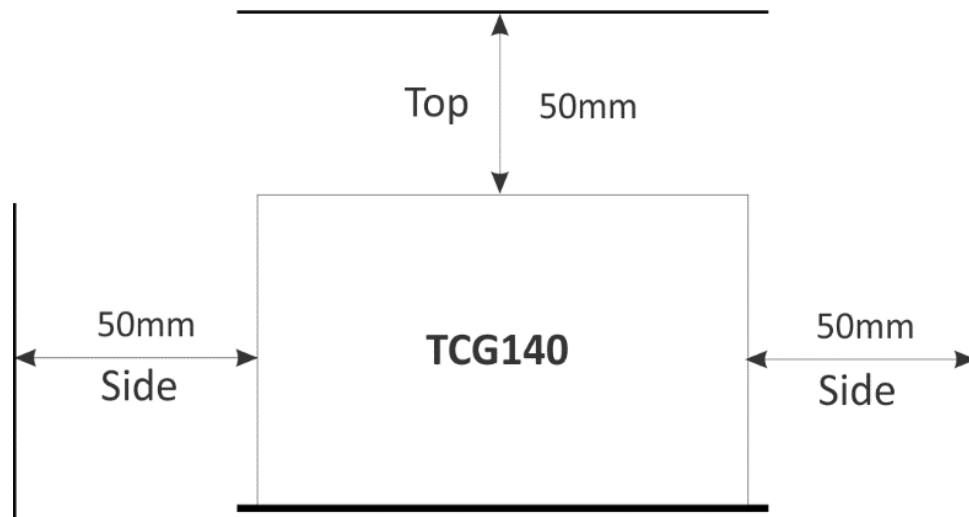

Fig.2