



RAS

Machine Access Box

USER GUIDE

The Machine Access Boxes family (RAS) is manufactured by

ETIC TELECOM
13 Chemin du vieux chêne
38240 MEYLAN
FRANCE

TEL: + (33) (0)4-76-04-20-05
E-mail: hotline@etictelecom.com
web: www.etictelecom.com

UE DECLARATION OF CONFORMITY

The manufacturer, ETIC Telecom – 13 chemin du vieux chêne – 38240 Meylan – France, Hereby declares under sole responsibility that the listed devices conform to

- the Radio Equipment Directive (RED) 2014/53/UE,
- the Restriction of the use of certain Hazardous Substances (RoHS) Directive 2011/65/UE.

Type of device: Machine Access Box - RAS

Models:

RAS-E-400, RAS-E-2XX, RAS-EW-400, RAS-EW-2XX, RAS-EC-400, RAS-EC-2XX, RAS-ECW-400, RAS-ECW-2XX, RAS-E-100, RAS-EW-100, RAS-C-100

The harmonized standards to which these devices comply are:

Standard	Title
EN 61000-6-2 2006	Immunity: EN61000-4-2 Electrostatic Discharge EN61000-4-3 RF Radiated Immunity EN61000-4-4 EFT/Burst Immunity EN61000-4-5 Surge Immunity EN61000-4-6 RF Conducted Immunity EN61000-4-8 Power Frequency Magnetic Field Immunity
EN 61000-6-4 2007 A1/2011	Emission: EN55032 Radiated and conducted emission
EN 301 489-1 V1.9.2 EN 301 489-3 V1.6.1 EN 301 489-7 V1.3.1 EN 301 489-17 V2.2.1 EN 301 489-24 V1.5.1	Radio - EMC
EN 301 511 V9.0.2 EN 301 908-1 V6.2.1 EN 301 908-2 V6.2.1 EN 300 328 V1.9.1 EN 301893 V1.8.1	Radio - Spectrum
EN 62368-1 2014 EN 62311 2008	Safety and Health

Date: 7th February 2019

Philippe Duchesne
Technical Director



FCC/IC Regulatory notices (RAS-X-100 models)

This device complies with Part 15 of the FCC. Operation is subject to the following two conditions: (1) this device may not cause interference, and (2) this device must accept any interference, including interference that may cause undesired operation of the device.

This equipment has been tested and found to comply with the limits for a Class A digital device, pursuant to Part 15 of the FCC Rules. These limits are designed to provide reasonable protection against harmful interference when the equipment is operated in a commercial environment. This equipment generates, uses, and can radiate radio frequency energy and, if not installed and used in accordance with the instruction manual, may cause harmful interference to radio communications. Operation of this equipment in a residential area is likely to cause harmful interference in which case the user will be required to correct the interference at his own expense.

Caution: ETIC Telecom has not approved any changes or modifications to this device by the user. Any changes or modifications could void the user's authority to operate the equipment.

OVERVIEW	7
1 Purpose of this manual	7
2 Products Identification	7
3 Specifications.....	8
4 Product overview	12
4.1 Main functions of the RAS	12
4.2 RAS organization	13
4.3 The M2Me_Connect connection.....	14
4.4 Benefits of the M2Me_Connect service	15
5 Use cases	16
INSTALLATION	17
1 Description	17
1.1 Dimensions	17
1.2 Connectors.....	18
1.3 Push-buttons.....	23
1.4 LED indicators.....	24
2 Safety instructions.....	25
3 DIN rail mounting	26
4 Cooling.....	26
5 Power supply.....	27
6 Earthing	27
7 RS232 serial connection.....	27
8 RS485 serial connexion	27
9 Digital input and output	28
10 Connecting the RAS to the cellular network	28
10.1 Controls before installing the RAS.....	28
10.2 Cellular antenna	29
10.3 Coaxial cable.....	29
10.4 Cellular service subscription	29
10.5 Installing the SIM card.....	30
10.6 Controlling the conformance of the connection	31
PREPARING THE SETUP	33
1 Connecting a PC for configuration	33
1.1 Overview.....	33
1.2 First configuration	34
1.3 Changing the configuration later	34
2 Access to the administration server through the WAN interface	35
3 Working with HTTPS.....	35
4 Temporary return to the factory settings	36
5 Restoring the factory settings.....	36
6 Protecting the access to the administration server.....	37
USING THE WIZARD	39
1 Use cases	39
2 Use case 1	40

TABLE OF CONTENTS

3	Use case 2	41
4	Use case 3	42
5	Use case 4	43
6	Use case 5	44
7	Use case 6	45
8	Example: Access to the Internet via the Ethernet WAN network	46
	ADVANCED SETUP	51

OVERVIEW

1 Purpose of this manual

The present user guide describes the features and the installation of the Machine Access Boxes family (RAS).

In this document, these products are named « RAS ».

2 Products Identification

This family of Machine Access Boxes consists of these models:

RAS-E-400, RAS-E-2XX,
 RAS-EW-400, RAS-EW-2XX,
 RAS-EC-400, RAS-EC-2XX,
 RAS-ECW-400, RAS-ECW-2XX,
 RAS-E-100, RAS-EW-100, RAS-C-100

The main features are summarized below:

	Models											
	RAS-	E-100	EW-100	C-100	E-400	E-220	EW-400	EW-220	EC-400	EC-220	ECW-400	ECW-220
WAN Ethernet		•	•		•	•	•	•	•	•	•	•
WAN Cellular (-HG, -HW : 3G+, -LE : 4G)				•					•	•	•	•
Wi-Fi 2.4 and 5 GHz			•				•	•			•	•
LAN Ethernet 10-100 Mb/s		1	1	1	4	2	4	2	4	2	4	2
Serial link RS232 /RS485						•		•		•		•
USB					•	•	•	•	•	•	•	•
GPS option (with ANT405)					•	•	•	•	•	•	•	•
2 power inputs					•	•	•	•	•	•	•	•
Power supply VDC		12-24	12-24	12-24	12-48	12-48	12-48	12-48	12-48	12-48	12-48	12-48
2 SIM readers									•	•	•	•
Digital input					1	1	1	1	1	1	1	1
Digital output					1	1	1	1	1	1	1	1

In the remainder of this document the term RAS-X is used indifferently for RAS-C, RAS-E, RAS-EC, RAS-EW and RAS-ECW.

OVERVIEW

3 Specifications

General characteristics	
Dimensions	RAS-X-100: 120 x 37 x 88 mm (h,w,d) Other RAS: 135 x 47 x 115 mm (h,w,d)
Weight	Max 0.65 kg
Casing	Metallic RAS- X-100: IP41 – IEC60529 Other RAS: IP20 – IEC60529 DIN rail mounting
Temperature	Non-operating: -40°/ + 85°C Operating: -20°/ + 70°C
Humidity	5 to 95 % relative (non-condensing)
Power supply	Protected against reverse polarity RAS-X-100: Nominal: 12-24 VDC (min 10 VDC - max 30 VDC) Other RAS: Nominal: 12-48 VDC (min 10 VDC - max 60 VDC) 2 points Phoenix connector
Consumption	RAS-E: 2W RAS-EC et RAS-EW: 5W RAS-ECW: 8W
EMC	Immunity EN61000-6-2: EN61000-4-2 : ESD : 4 kV contact – 8kV air EN61000-4-3 : RF - radiated: 10V/m < 2 GHz EN61000-4-4 : Burst EN61000-4-5 : Surge EN61000-4-6 : RF - conducted EN61000-4-8 : Magnetic fields Emission EN61000-6-4: EN 55032: RF - conducted and radiated FCC: RAS-X-100 : FCC Part 15
Electrical safety	IEC/EN 62368-1 RAS-X-100 : CB FR_704843
Hazardous substances	2011/65/UE (RoHS) REACH

WAN network	
Ethernet	RJ45 Auto: 10/100 full & half duplex MDI/MDI-X
4G/3G+	-LE : 4G LTE Europe LTE bands: B1, B2, B3, B4, B5, B7, B8, B20 UMTS bands: B1, B2, B5, B8 GSM bands: 850/900/1800/1900 -CH : 4G LTE China LTE bands: B1, B3, B8, B38, B39, B40, B41 UMTS bands: B1, B5, B8, B9 GSM bands: 900/1800 -HG : 3G+ HSPA worldwide (except. North America) UMTS bands: B1, B2, B5, B8 GSM bands: 850/900/1800/1900 -HW : 3G+ HSPA worldwide UMTS bands: B1, B2, B4, B5, B6, B8, B19 GSM bands: 850/900/1800/1900 Max data rate 4G: UL @ 50 Mbps and DL @ 100Mbps Max data rate 3G+: UL @ 5,7 Mbps and DL @ 21 Mbps Max data rate 2G: UL @ 237 Kbps and DL @ 237 Kbps Antenna connector female SMA
Wi-Fi	Client 2.4 and 5 GHz 802.11 a/b/g/n Antenna connector female RP-SMA

LAN network	
Ethernet	RJ45: 1 to 4 ports depending on model Auto: 10/100 full & half duplex MDI/MDI-X
Wi-Fi	Access point 2,4 and 5 GHz 802.11 a/b/g/n Antenna connector female RP-SMA

Routing / @IP	
IP Routing	Routing tables Static routes RIP or OSPF Address translation (DNAT, SNAT, NAT 1:1)
IP@ assignment	WAN interface: DHCP client or fixed IP LAN interface: DHCP server
DNS	WAN interface: compatible with DYNDNS, No-IP or ETIC DNS LAN interface: DNS relay & server
Redundancy	VRRP RFC 3768 protocol Multi WAN for backup on some RAS models

OVERVIEW

Security	
VPN tunnel	OpenVPN (TLS/SSL), IPSEC, L2TP/IPSEC, PPTP Shared key or X509 certificate Encryption 3DES & AES 128-192-256 Authentication: MD5 & SHA-1 Up to 10 VPN tunnels (mix OpenVPN IPSEC allowed)
Firewall	Statefull packet inspection (SPI: 50 rules) IP@ and ports filtering
Log	Timestamped Events: connection, restart, alarms
Alarms	Digital input: email, SMS, SNMP trap Digital output: Power supply failure, user connection...

Serial gateways	
Gateways	Raw TCP client Raw TCP server Raw UDP Raw Multicast Modbus TCP client to Modbus RTU/ASCII slave (for master PLC) Modbus TCP server to Modbus RTU/ASCII master (for slave PLC) Telway/XIP to Unitelway slave (for master PLC) Telnet RFC 2217
RS232/RS485	Data rate : 1200 to 115200 kb/s, 10 or 11 bits, parity N / E / O RS232 : RJ45 RS485 : 2 points Phoenix connector
USB	1 port USB host PPP client

Misc.	
SNMP	Supported MIBs: RFC1213-MIB (MIB-2) ETIC-TELECOM-MIB-1 SNMP traps
Configuration	Web server
Management	Save and restore configurations Reset product to return to factory configuration

M2Me solution	
Users	Up to 100 remote users
Alarms	Compatible with «EticDisplay» solution
Security	RAS access: Login & Password and Certificate (optional) Single RAS product key required for the remote user Customizable LAN machine network access rights
Communication	Secured connection on to the M2Me_Connect service OpenVPN
Management	« Collect & Alert » Recording on USB flash drive, µSD card or internal memory Email and SMS alarms « Pack SMS » Options managed from the client area of the WEB site
M2Me client	PC: All OS versions up to W10 Smartphone and Tablet: Android et iOS
M2Me_Connect	VPN Tunnel Secure interconnection service
RAS Manager	RAS fleet management centralised (option)

4 Product overview

4.1 Main functions of the RAS

Remote maintenance of machines using the M2Me_Connect service

The RAS family allows to connect easily and safely a machine to a remote PC, through the M2Me_Connect Internet cloud service, for operation like remote maintenance.

When the remote PC is connected, the remote user can exchange any kind of data with each device of the machine network as if his PC was directly connected to the machine network.

Ethernet or serial devices

The machine can consist of one or several devices connected through an Ethernet machine network or connected through a serial RS232-RS485 interface.

The RAS can be connected to the Internet through a cellular network, a Wi-Fi network or a factory network

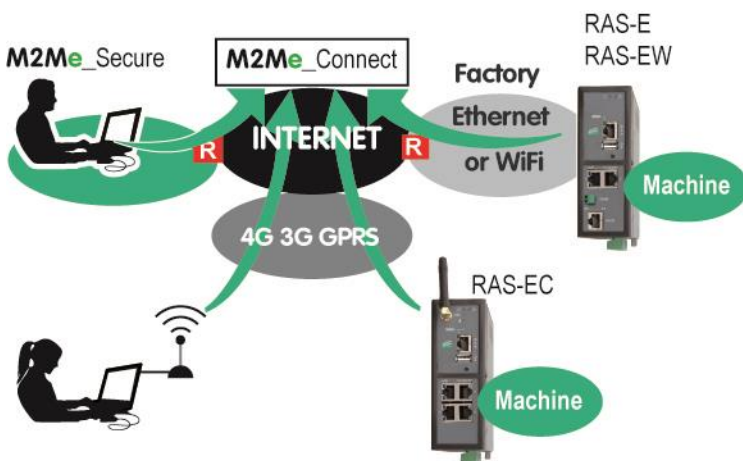

An Up-to-date IP router for particular situations

When using the Expert mode set-up, the RAS becomes a powerful IP router-RAS-firewall for industrial IP networks applications.

4.2 RAS organization

The RAS connects to the devices network (called machine) and on the other hand to the Internet.

The RAS provides two IP interfaces: The WAN interface to reach the Internet and the LAN interface to connect the machine.

WAN interface:

Depending on the model, the RAS provides the following interfaces to reach the Internet:

	WAN interfaces				
	RAS-E	RAS-EW	RAS-C	RAS-EC	RAS-ECW
Ethernet	●	●		●	●
Wi-Fi		●			●
Cellular			●	●	●

The network connected to the WAN interface is called the WAN network or factory network.

LAN interface:

Depending on the model, the RAS provides 1 to 4 switched Ethernet ports to connect the devices of the machine.

That network is called the machine network.

1 serial RS232 and 1 serial RS485 interfaces are provided optionally.

Firewall

The firewall filters data between the WAN interface or any VPN interface on one hand, and the LAN interface on the other hand.

The firewall filters source and destination IP addresses, but also remote users according to their identity.

OVERVIEW

4.3 The M2Me_Connect connection

Connecting a remote PC to a machine in any situation

M2Me Connect service is an ideal solution when a « machine », made of a set of devices connected to the same LAN, is located in a private network (such as a Factory network).

Let's take the example of a « machine » made of a set of connected devices and connected to the Factory Network via a RAS-E.

Assuming that an expert is willing to remotely have access to the machine for breakdown diagnosis, technical data acquisition, Web page display, file or program refreshment, M2Me Connect service enables the remote operator to have access to the machine even if the machine does not have any public IP address.

Operation

When it is powered on or if the digital input is enabled, the RAS settles a secured VPN connection onto the M2Me Connect cloud service.

The remote PC is authenticated by the M2Me Cloud service.

If the RAS provides two WAN connections (cellular and Ethernet, for example), it establishes the most favorable connection as defined in the configuration of the RAS (In principle Ethernet with cellular backup).

On the other hand, the remote user launches its M2Me secure software and settles a secured VPN connection to the M2Me Cloud.

The directory offered by M2Me_Secure is helping the user to point the remote machine onto which he wants to be connected.

The RAS verifies then after that the remote user is allowed to be connected by checking its login & password and as an option the certificate of the remote PC.

The RAS grants to the remote user access rights according to its identity.

In order to warrant the level of security requested by industrial application, connection from PC to RAS is fully encrypted and cannot be recovered even in case of intrusion onto the M2Me Connect cloud service.

4.4 Benefits of the M2Me_Connect service

Outgoing connection

M2Me connection onto the Internet is powered from the RAS. This non-intrusive solution is better admitted than an incoming connection from the Internet onto the Machine.

Private & dynamic IP address

The machine connected into a factory network or connected to the Internet via a cellular network does not have a public IP address. M2Me solution does not require a public IP address to settle a connection onto the machine.

Access to each device of the machine

M2Me teleport your PC onto the machine network enabling you to have access to each device of the machine as if you were in front of the machine.

Machine with Ethernet or serial connection

The family of RAS enables you to set up a connection to any type of PLC offering an Ethernet or a serial connectivity.

Simple configuration

Html configuration Server is delivered with a Wizard which gives an intuitive way of configuring the device.

Simple Operation

M2Me Secure software offers a set of directories for the remote machines. One click is enough to be connected.

Security of customer network (Factory or WAN network)

RAS enables the remote operator to have access only to the machine network protecting the factory network from any intrusion.

Machine & Device Access protection

A remote user can access to the machine if and only if its identification (login & password) has been preregistered in the RAS.

An extra security option is offered. RAS can also demand the certificate installed in the PC of the remote user.

The RAS can also give restricted access to the machine network giving access only to certain devices of the machine and not to all.

Internet & Security

The flow of information passing through the M2Me connection is fully encrypted and requires authentication to the M2Me server of both the PC of the remote user and the RAS. A third party cannot consequently have access to the machine preserving the integrity of the industrial process to be remote maintained.

OVERVIEW

5 Use cases

There are different ways to connect the RAS to the Internet and to the machine depending on the situation which is encountered and also on the RAS model.

At the setup time, the wizard proposes all or part of these situations according to the model; just select the appropriate situation and be guided to implement the Internet connection and the list of users.

The other functions can be configured with the Expert mode.

Use case	Internet access	Description	
1 Any models	Factory network	The Machine is connected to the Internet via the Factory network through the RAS.	
2 Any models	Factory network	The machine belongs to the Factory network.	
3 RAS-EC RAS-ECW	Cellular network	The machine is connected to the Internet via a cellular network.	
4 RAS-EW RAS-ECW	Wi-Fi	The machine is connected to the Internet via a Wi-Fi network.	
5 RAS-EC RAS-ECW	Factory network + cellular network	The machine is connected to the Internet via the Factory network and, if it is not available, via a cellular network.	
6 RAS-ECW	Wi-Fi + cellular network	The machine is connected to the Internet via the Wi-Fi network and, if it is not available, via a cellular network.	

INSTALLATION

1 Description

1.1 Dimensions

All models except RAS-X-100

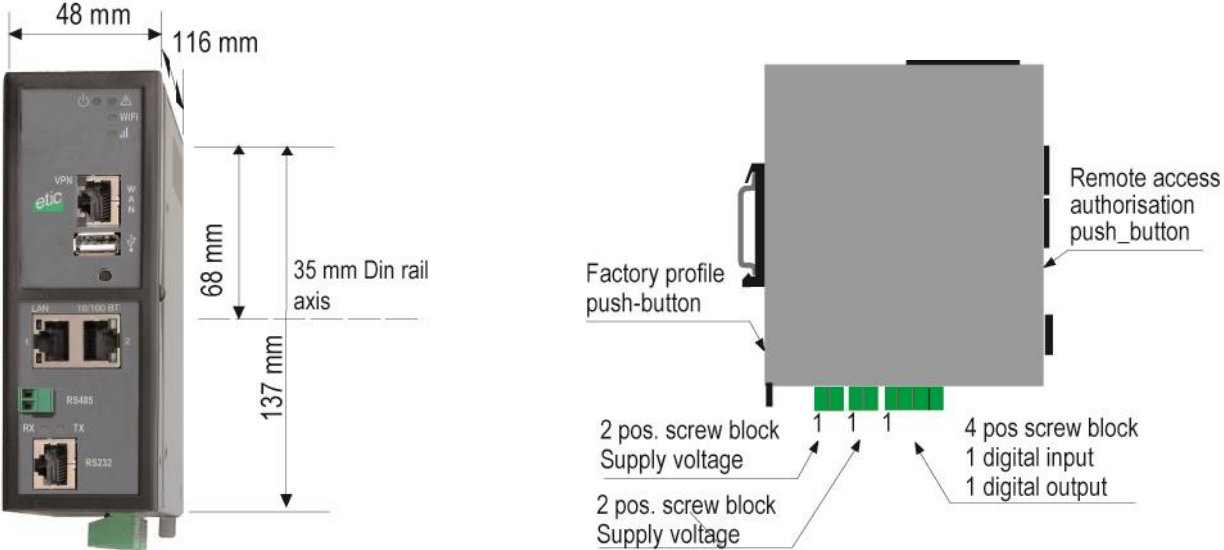

RAS-X-100

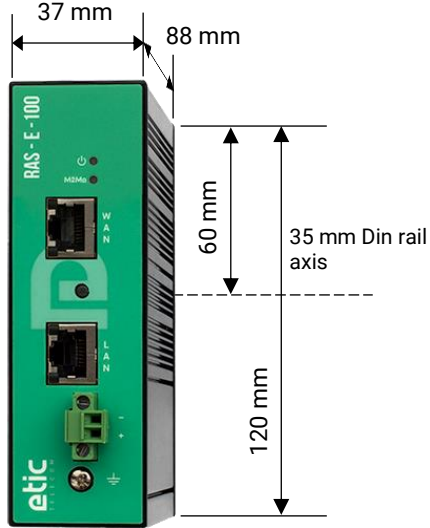

INSTALLATION

1.2 Connectors

RAS-E-400

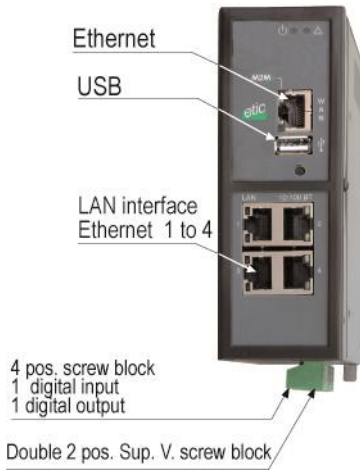

RAS-EW-400

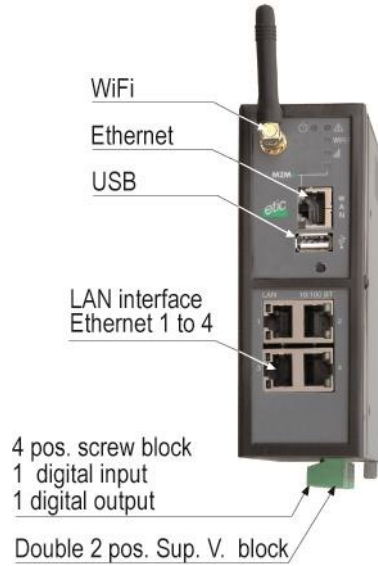

RAS-E-220

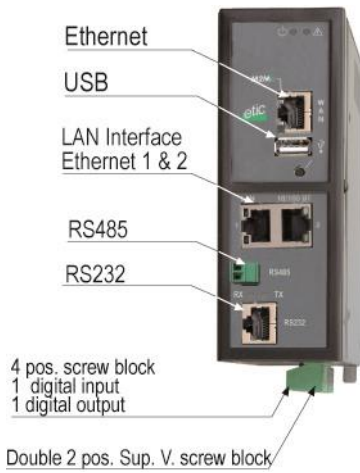

RAS-EW-220

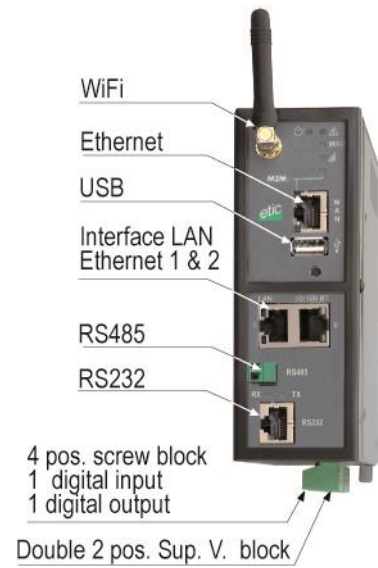

RAS-EC-400

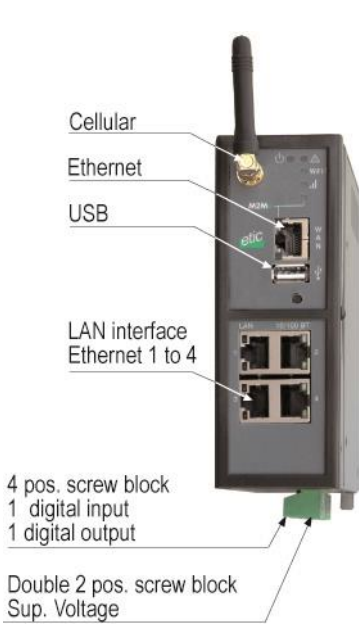

RAS-ECW-400

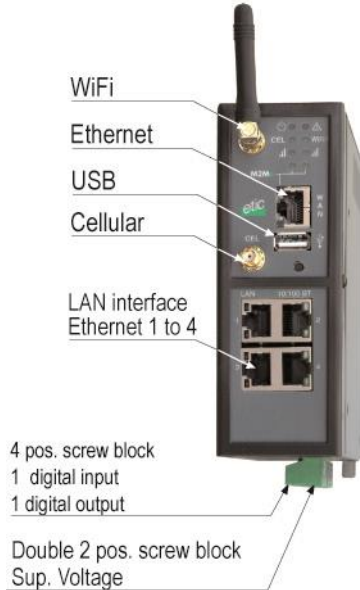

RAS-EC-220

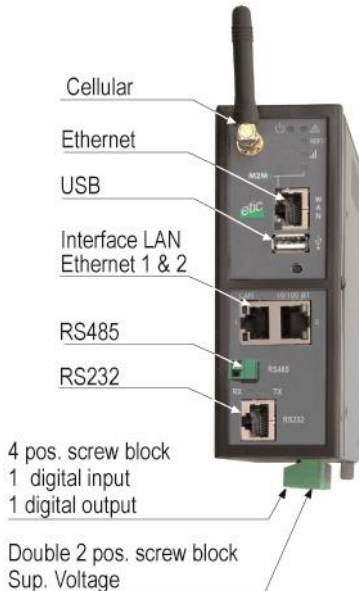

RAS-ECW-220

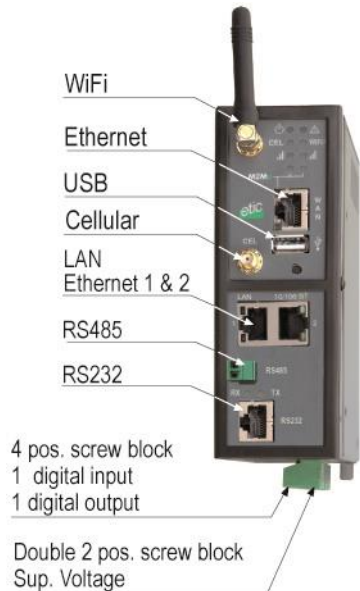

INSTALLATION

RAS-E-100

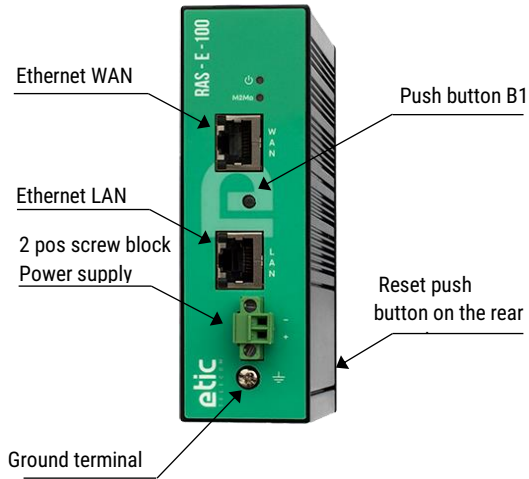

RAS-EW-100

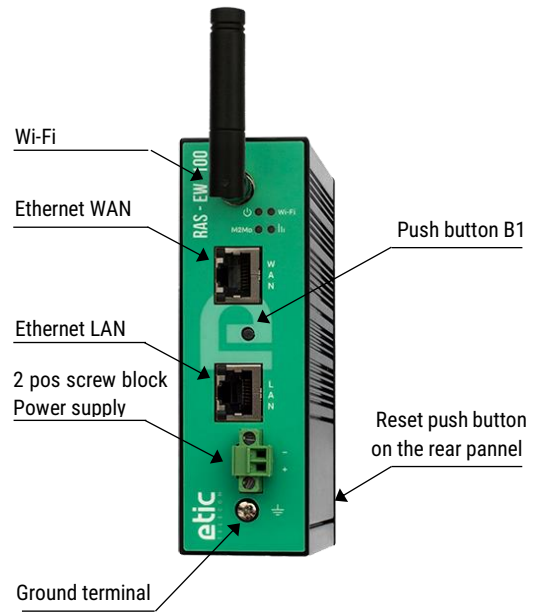

RAS-C-100

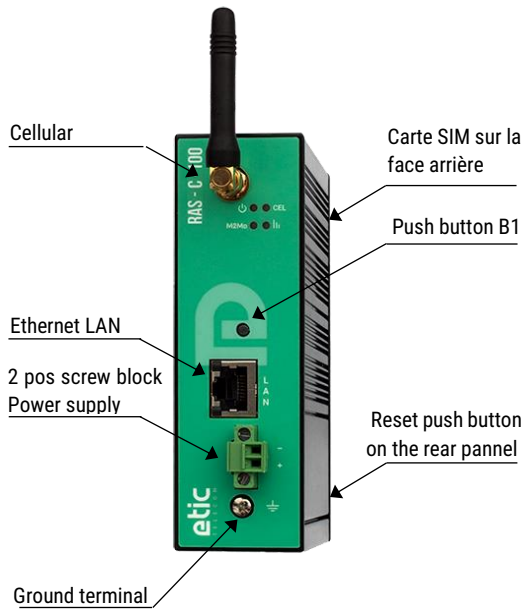

All models except RAS-X-100 Ground terminal	
Symbol	Description
	FASTON male lug 6.35 mm

Ground terminal	
Symbol	Description
	M4 screw terminal

All models except RAS-X-100 2 positions screw terminal: Supply voltage 1 Position 1 at back – Protected against reverse polarity		
Position	Signal	Function
1	Power 1 +	12 - 48 VDC
2	Power 1 -	0V

All models except RAS-X-100 2 positions screw terminal: Supply voltage 2 Position 1 at back – Protected against reverse polarity		
Position	Signal	Function
1	Power 1 +	12 - 48 VDC
2	Power 1 -	0V

RAS-X-100 2 positions screw terminal: Supply voltage Protected against reverse polarity		
Position	Signal	Function
1	Power 1 +	12 - 24 VDC
2	Power 1 -	0V

All models except RAS-X-100 4 positions screw terminal: Digital input and output Position 1 at back		
Position	Signal	Function
1	0V	Digital input 0V
2	In	Digital input
3	F +	Digital output + (max 50Vdc - 0,1A)
4	F -	Digital output -

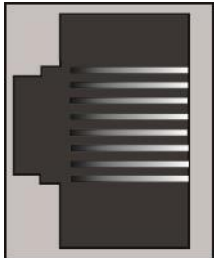
Ethernet RJ45 connector			RJ45 
Position	Signal	Function	
1	Tx +	Emission polarity +	1 8
2	Tx -	Emission polarity -	
3	Rx +	Reception polarity +	
4	N.C.	-	
5	N.C.	-	
6	Rx -	Reception polarity -	
7	N.C.	-	
8	N.C.	-	

INSTALLATION

Antenna connectors			
Antenna	Network	Type	Observation
CEL	Cellular	SMA female	3G et 4G
AUX	Cellular	SMA female	To improve the 4G transmission data rate, 2 antennas can be connected (RAS-EC-400 -LE and RAS-EC-220-LE only)
Wi-Fi	Wi-Fi	RP-SMA female	Reverse polarity connector compliant with Wi-Fi antennas.

RAS-X-220 2 positions screw terminal : RS485		
Position	Signal	Function
1	A	RS485 polarity A
2	B	RS485 polarity B

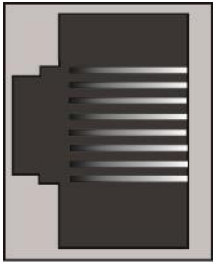
RAS-X-220 RJ45 connector : RS232 To connect a DCE				
Position	Signal	Direction	Function	RJ45
1	DTR - 108	OUT	Data terminal ready	
2	TD - 103	OUT	Data Emission	
3	RD - 104	IN	Data Reception	
4	DSR - 107	IN	Data set ready	
5	SG - 102	-	Ground	
6	Not used	OUT	-	
7	CTS - 106	IN	Clear to send	
8	RTS - 105	OUT	Request to send	

OUT = Signal supplied by the RAS.

IN = Signal supplied by the external device.

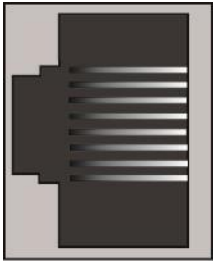
RAS-X-220 RJ45 connector : RS232 To connect a DTE				
Position	Signal	Direction	Function	RJ45
1	CD - 109	OUT	Carrier detect	
2	RD - 104	OUT	Data Reception	
3	TD - 103	IN	Data Emission	
4	DTR - 108	IN	Data terminal ready	
5	SG - 102	-	Ground	
6	DSR - 107	OUT	Data set ready	
7	RTS - 105	IN	Request to send	
8	CTS - 106	OUT	Clear to send	

OUT = Signal supplied by the RAS.

IN = Signal supplied by the external device.





1.3 Push-buttons

Rear panel push-button		
Pressing the PB	LED 	Function
During operation	Flashing red	Temporary return to the factory configuration. (IP address 192.168.0.128) The current configuration is not lost.
During power-up	Flashing red	Return to the factory configuration. The current configuration is deleted except if it has been saved into a file.

Front panel push-button		
Pressing the PB	LED 	Function
10 seconds	5 flashes	The hotline of ETICTELECOM is authorized to connect remotely to the router administration server within a 1 hour delay.

INSTALLATION

1.4 LED indicators

LED indicators Depending on models		
Function	LED	Description
Operation		Off Power off Steady green The unit is ready Slow blinking green The unit is busy Steady red Startup (30s) – Hardware or software failure or SIM card missing or memory flash drive missing Fast blinking red Firmware download in progress
Application alarm		See Alert & Display application
Cellular connection	CEL	Off SIM card missing - wrong PIN code – Cellular interface disable Flashing every 4 s Interface enable - not connected Blinking slowly - 2 s Connection in progress (first step) Blinking fast - 0,5 s Connection in progress (password and IP@) Steady green Connected / Brief flashing when traffic on link
Cellular signal quality		Off No signal measured 1 flash Not sufficient signal 2 flashes Sufficient signal 3 flashes Strong signal
M2Me connection	M2Me	Off Not connected to M2Me_Connect service Blinking slowly - 2 s Connection in progress Steady green Connected
Ethernet WAN	Lower LED	Off Not connected or interface disable Green Connected / Brief flashing when traffic on link
Wi-Fi connection	Wi-Fi	Off Interface disable or enable as an access point Flashing every 4 s Interface enable - not connected Blinking fast - 0,5 s Connection in progress Steady green Connected / Brief flashing when traffic on link
Wi-Fi signal quality		Off Wi-Fi not enabled or enabled as an access point 1 flash Faint not sufficient signal 2 flashes Sufficient signal 3 flashes Strong signal
Ethernet LAN 1 to 4	Lower LED	Off Not connected or interface disable Green Connected / Brief flashing when traffic on link
RAS-EC-220 RAS–ECW-220		
RS232/RS485	Rx	Characters received from the RS232 or RS485 serial interface
	Tx	Characters transmitted to the RS232 or RS485 serial interface

2 Safety instructions

The product shall be installed in a fire electrical resistant cabinet by a qualified operator.

The product must be connected only to equipment that complies with the IEC60950-1 or IEC62368-1 standards and that meets the following classifications:

- IEC60950-1 : Limited power circuits and SELV type – §2.2 and 2.5
- IEC62368-1 : ES1 & PS2



The RAS-X-100 contain a non-replaceable lithium-metal battery. To avoid any risk of explosion or leakage of flammable liquid or gas, make sure to:

- not exceed the max temperatures specified during use, storage or transportation.
- not subject the product to a low pressure below 116mBar (15 000 m).
- not put this product into a fire or hot oven or cause mechanical cuts or crushing when disposing.



To avoid any risk of burns, it is strongly recommended to wear gloves to handle the product in operation when the ambient temperature exceeds 30 °C.

Cellular or Wi-Fi models:

- The antenna should be installed and operated with minimum distance of 20 cm between the radiator and your body.
- The antenna must not be co-located or operating in conjunction with any other antenna or transmitter.

INSTALLATION

3 DIN rail mounting

Mounting the unit on the 35 mm horizontal DIN rail

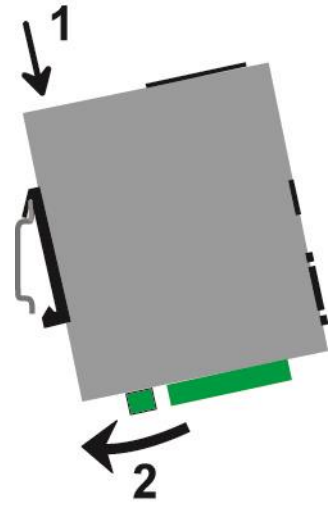

Removing the unit from the DIN rail

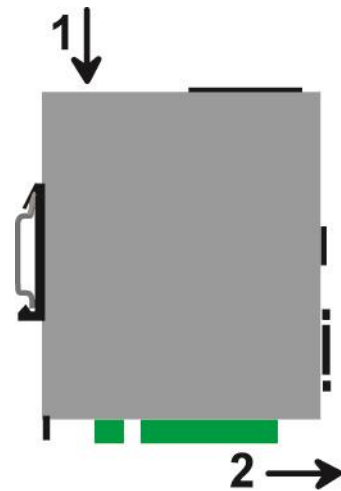

4 Cooling

The product is designed to be mounted on a 35mm DIN rail. To avoid obstructing the airflow around the unit, the spacing must be at least 25 mm above and below, and 10 mm left and right.

5 Power supply

All models except RAS-X-100 :

These products provide a dual power inputs allowing a redundancy power supply.
The supply voltage must be regulated and strictly between 10 and 60 Volt DC (nominal: 12 – 48 VDC).
At power up the inrush current can reach 20 A for 100 μ s.

RAS-X-100 :

These products provide a single power input.
The supply voltage must be regulated and strictly between 10 and 30 Volt DC (nominal: 12 – 24 VDC).
At power up the inrush current can reach 20 A for 100 μ s.

6 Earthing

For EMC reasons, the ground terminal must be connected to the functional (or protective) earth of the installation.

7 RS232 serial connection

Cables can be provided to connect the product to DTE and DCE as follows:

RS232 cables		
Reference	Connector	Function
CAB592	SubD 9 male	To connect a DCE to the product
CAB593	SubD 9 female	To connect a DTE to the product
CAB609	Wires	To connect a device providing a specific connector

The RS232 cable must be shorter than 10 meters.

8 RS485 serial connexion

The RS485 interface is not isolated.

Two 10 KOhm bus polarization resistors are included inside the product.

If the RS485 line is longer than 10 meters or if the data rate is greater than 19200 b/s, it is necessary to connect one 120 Ohm matching resistor at each end of the line and two 390 Ohm polarization resistors at one of the two extremities of the line.

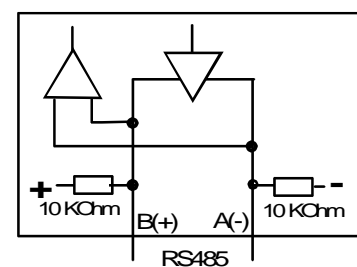

INSTALLATION

9 Digital input and output

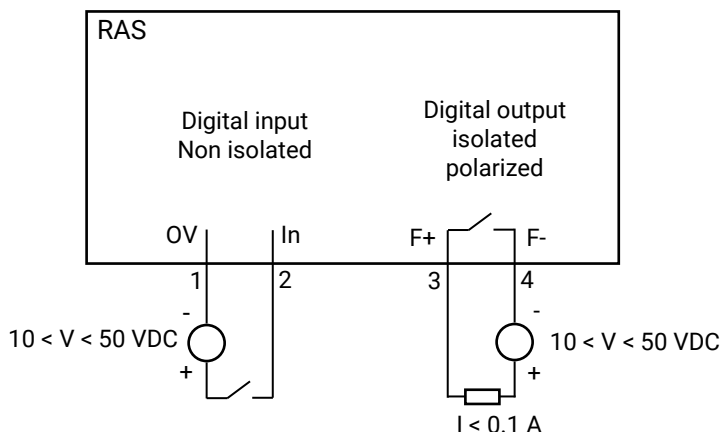

To check that the input and the output are correctly wired :

In the menu, select **Diagnostics > Hardware > Input/Output**

The status of the input is displayed and the output can be switched ON or OFF.

10 Connecting the RAS to the cellular network

10.1 Controls before installing the RAS

Authorization to use a cellular connection

Check the cellular connection is authorized at the location where the RAS is supposed to be installed.

Control of the reception level before installing the machine

Before installing the RAS, refer to a cell map over the Internet to check that the cellular reception signal is strong enough at the location where the machine is supposed to be installed.

Select the right mobile service provider.

Reception level confirmation

If the reception seems possible, confirm with a control on site.

The reception level can be measured with a smartphone.

Most smartphones provide the reception level information (parameters or diagnostic menu).

To carry-out that control, use mandatorily a SIM card subscribed with the mobile service provider selected for the RAS.

Remark:

The RAS itself provides the reception level information in two ways:

- A reception level led indicator

- The diagnostic menu of the administration web server

10.2 Cellular antenna

The antenna shall not be installed inside metal cases.

The antenna is supplied separately. Use only an approved antenna.

We provide a complete catalog of cellular antennas.

10.3 Coaxial cable

If necessary, the antenna can be connected to the RAS through a coaxial cable.

The signal attenuation in a usual coaxial cable is 0.2 to 0.4 dB / m, that is to say 2 to 4 dB for a 10 meters long cable.

If a coaxial cable must be used to connect the antenna to the RAS, the attenuation in the cable has to be taken into account to calculate the effective RF signal received by the RAS.

Refer to our cables and antennas catalogue.

10.4 Cellular service subscription

The RAS is designed to connect to the LTE-UMTS-GPRS data transmission service like the one used by the tablets.

The subscription should also provide the SMS service if SMS alarms are required.

A telephone service subscription is not needed.

One will take care to subscribe to a service authorizing the right volume of data per month (MB/month) and to check the price of the MB exceeding the limit of the subscription plan, if it exists.

The subscription must be preferably signed in the country where the machine is supposed to be installed to avoid roaming costs.

INSTALLATION

10.5 Installing the SIM card

All cellular IPL models except RAS-C-100

These models provide two SIM card holders. If you use only one SIM card, use the SIM card holder Nr 1 (at left on the pictures).

Installing the SIM card:

- Power off the RAS.
- Remove the anti-steal lid at the top of the product
- Insert the SIM card according to the drawing.
- Push the card until it locks.



Removing the SIM card:

- Power off the RAS.
- Remove the anti-steal lid at the top of the product.
- Push on the SIM card to unlock it.
- Remove the SIM card.



RAS-C-100

Installing the SIM card:

- Power off the RAS.
- With a small tool, push on the button to release the SIM card holder on the back.
- Insert the SIM card into the card holder as shown in the picture.
- Position the card holder in the slides le.
- Push the card until it locks.

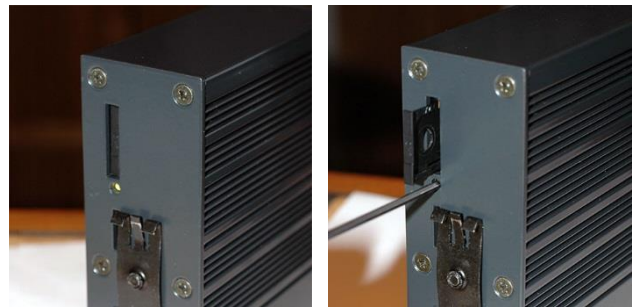

Removing the SIM card:

- Power off the RAS
- With a small tool, push on the button to release the SIM card holder on the back.
- Remove the SIM card from the card holder and put it back in place.

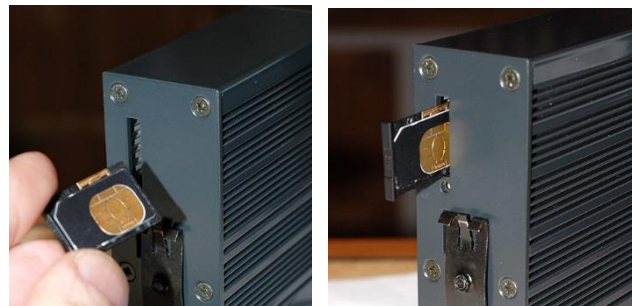

10.6 Controlling the conformance of the connection

After installing and setting up the RAS, control the conformance of the connection:

Reception level

The reception level must be better than -90 dBm (two flashes of the reception level led indicator). See the table below.

PING error rate

Each PING request must receive an answer.

Network response delay to a PING request

The response delay must be better than 500 ms.

If the delay is longer than one second, it means the network is overloaded or that the signal level is weak.

If the connection is not conform, change the position of the antenna or select an alternative service like UMTS instead of LTE for instance.

 Cellular network reception level LED		
State	Description	Reception level dBm
3 flashes	<u>Strong signal</u>	-50 à - 80
2 flashes	<u>Sufficient signal</u> The connection is reliable but the data rate may be reduced due to transmission errors.	-81 à -90
1 flash	<u>No sufficient signal</u> Connection drops and errors may append. Try to improve the reception level.	-91 à -110
Off	<u>No signal</u> Check the antenna connector and the presence of the SIM card.	< -111

To control the signal level with the html server:

- In the menu, select **Diagnostics > Network status > Interfaces**.

PREPARING THE SETUP

1 Connecting a PC for configuration

1.1 Overview

The RAS is configured using a PC with an HTML browser. No additional software is required.

Online help:

For most pages of the administration server an help page is available by clicking [?](#) located at the top right of the page.

Administration server address:

When the product is delivered, the IP address of the administration web server is 192.168.0.128.

First setup:

For the first configuration, we advise to connect the PC directly to the LAN interface of the RAS. Subsequent changes can be made remotely.

Restoring the factory IP address:

The factory IP address 192.168.0.128 can be restored (see the User guide of the product).

Restricted access to the administration server:

If you do not have access to the administration server, it is probably that access has been restricted for security reasons or for other reasons.

Network IP address:

Later in the text, we often speak of "network IP address". We mean the lowest value of the addresses of the network.

For instance, if the netmask of a network is 255.255.255.0, the network IP address of that network is terminated by a zero (X.Y.Z.0.).

Characters allowed

Accented characters are not supported.

PREPARING THE SETUP

1.2 First configuration

Step 1: Create or modify the PC TCP/IP connection

Assign to the PC an IP address different but consistent with the factory IP address of the RAS. For the first configuration, assign for instance 192.168.0.1 to the PC.

Step 2: Connect the PC to the RAS

Connect the PC directly to the RAS with any Ethernet cable (straight or cross-wired);

Step 3: Launch the web browser

Launch the web browser and then enter the IP address of the RAS : 192.168.0.128

The Home page of the administration server is displayed.

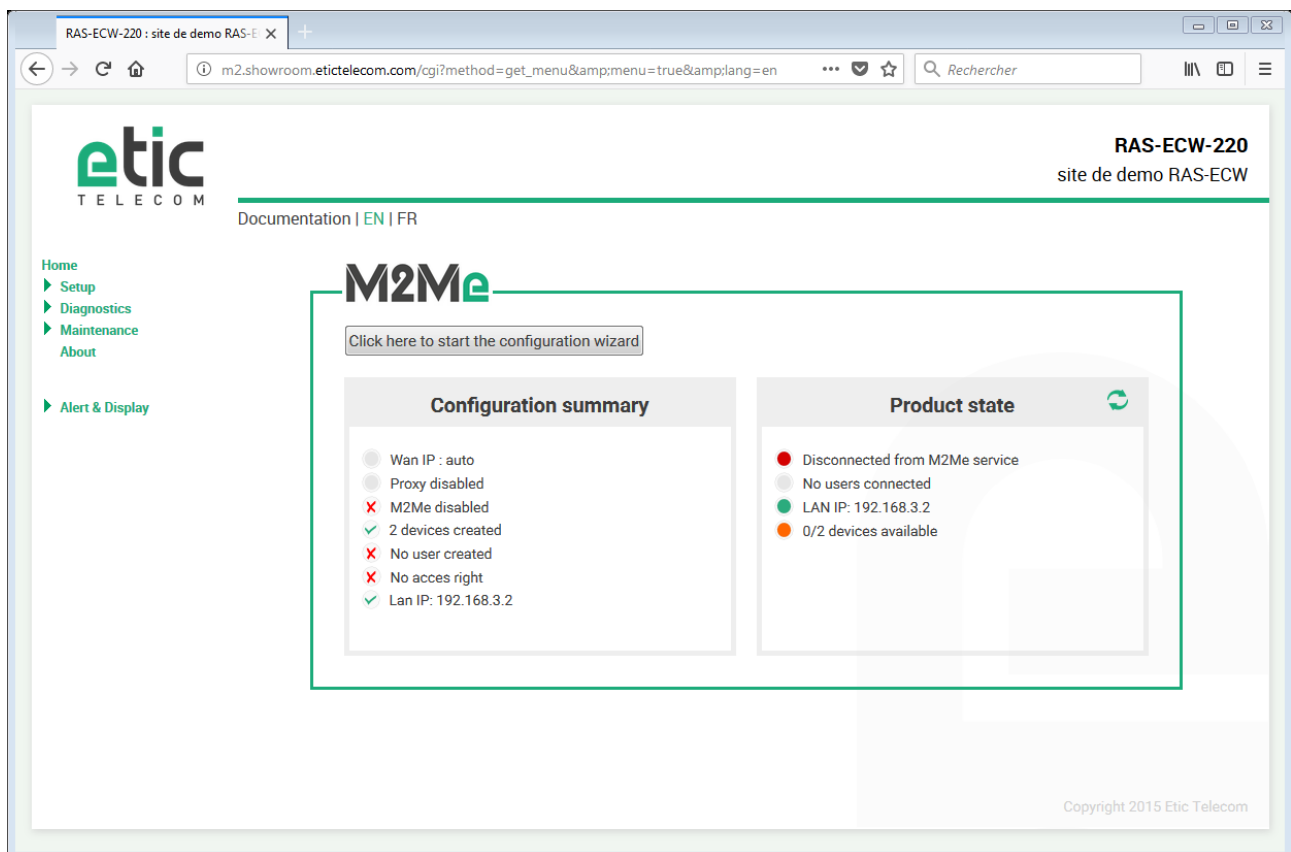

Note: Access to the administration server is not protected when configuring the RAS for the first time.

1.3 Changing the configuration later

Thereafter, the RAS administration server is accessible from the local Ethernet interface or remotely through a remote connection at the IP address assigned to the product.

By default, the access to the administration web server is not allowed through the WAN interface.

2 Access to the administration server through the WAN interface

To allow the access to the administration server through the WAN interface:

- In the menu, choose **Setup > Security > Administration rights**.
- Enter the username and the password.
- Select the protocol to use for configuration **HTTPS only** or **HTTP and HTTPS**.
- Tick the **Enable access from the WAN(s)** checkbox.

The administration server is accessible with HTTPS through the WAN or the LAN interface.

3 Working with HTTPS

Once HTTPS has been selected, proceed as follows:

The port 4433 is assigned to administration server.

- Open the web browser and enter the IP address of the RAS administration server:
Example: <https://192.168.38.191:4433>.
- Click **Next** when a warning message is displayed
- Enter the user name and password that have been set to protect access to the administration server.

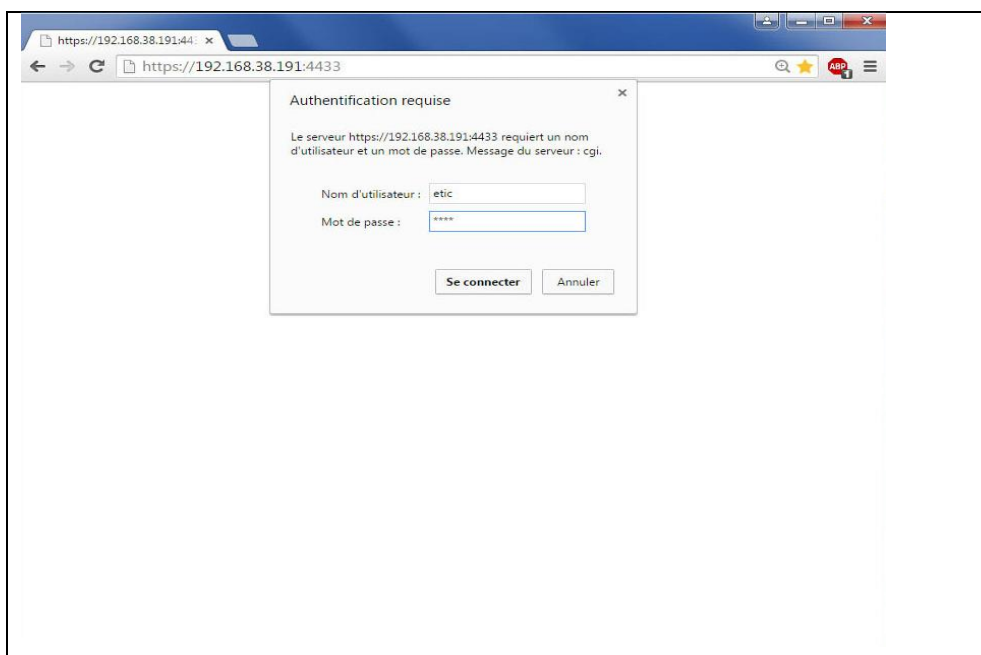

The home page of the administration server is displayed.

PREPARING THE SETUP

4 Temporary return to the factory settings

If the IP address of the RAS could not be founded, or if it is impossible to access the administration server, for example, following a configuration error, it is possible to restore the factory settings without losing the current configuration.

- Press the push-button located on the back, for example with a small screwdriver
- Keep the push-button pressed for about 3 seconds;
- The LED  blinks red rapidly
- The administration server becomes accessible at the factory IP address (192.168.0.128) ; The factory configuration is temporarily running.
The administration server is accessible without a password in HTTP.
However, the current configuration is not lost and it is the one that is still displayed in the pages of the Administration Server.
- After reading the IP address or changing some parameters, press again the push button or reboot the product.
The product can be reached at the registered IP address.

Note:

If the IP address of the RAS is unknown, the software tool [EticFinder](#) can be used.

This software detects all ETIC branded products on a local network. After starting the software, click on the "Search" button, and when the product list is displayed, double-click on the product address to access the html server.

5 Restoring the factory settings

It is possible to restore the factory configuration permanently using the push button on the rear panel, or by using the administration server. In this case, the current configuration will be lost unless it has been saved to a file.

To restore the factory settings using the push button,

- Power off the RAS,
- Press the push-button located on the back, for example with a small screwdriver,
- Power on the RAS, while keeping the push-button pressed at least 10 s.

The LED  turns red; the RAS boots and the factory configuration is restored.

Note: The factory configuration can also be restored via the menu [Maintenance > Configurations management](#) of the administration server.

6 Protecting the access to the administration server

- In the menu, choose **Setup > Security > Administration rights**
- Enter a user name and password to protect the administration server.
- Tick the **Password protect the web site access** checkbox

If the username and password to access the administration server are lost, you have to [temporarily return to the factory settings](#); access to the administration server is then free.

USING THE WIZARD

1 Use cases

The Wizard simplifies set-up of the RAS.

6 use cases can be selected. Each case corresponds to the situations that can be encountered. It takes place in 5 stages:

- 1. Use case selection
- 2. M2Me connection
- 3. Machine network
- 4. Remote users
- 5. Summary

The choice of the outgoing access to Internet defines the use case. Then simply be guided by the wizard until the final summary to verify that everything has been configured correctly.

To setup the RAS using the wizard,

- Launch the administration web server and click **Start the configuration wizard**.

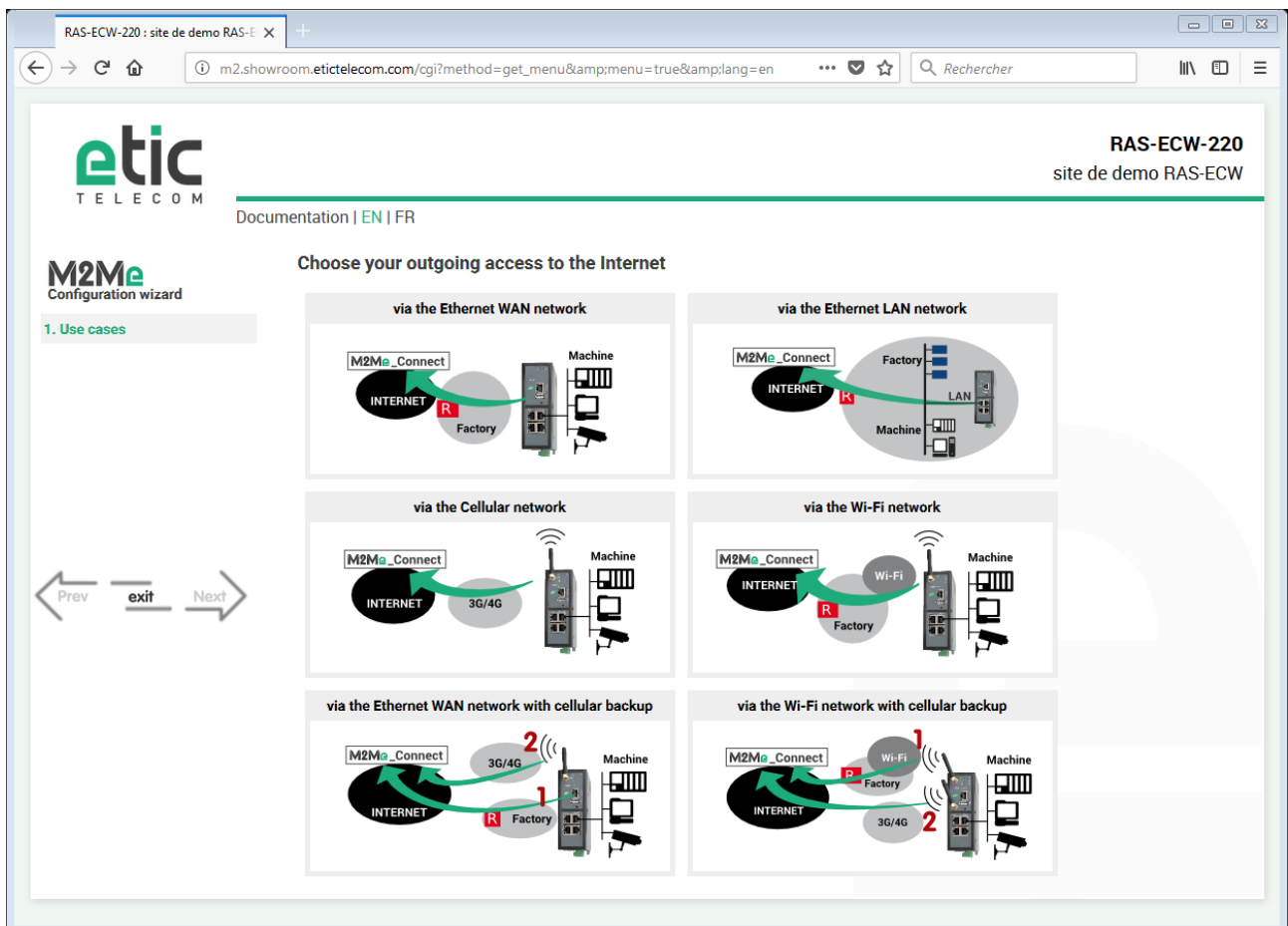

USING THE WIZARD

2 Use case 1

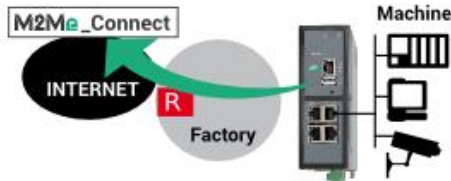
<p>The Machine is connected to the Internet via the Factory network through the RAS. The RAS is installed between the Factory network and the Machine network. The machine devices are separated from the Factory network by the RAS.</p>	
---	--

Models	Internet access	Internet interface	Machine interface
Any models	Factory or company network	Ethernet WAN	Depending on models : Ethernet LAN Serial interface

Rules for assigning IP addresses:

The network IP address of the Machine and the network IP address of the Factory must be different.
 If both network IP address are identical, the devices IP address of the machine must be modified.

The network IP address of the Machine and the network IP address of remote PC must be different.
 If both network IP address are identical, the devices IP address of the machine must be modified or a network address translation is needed to avoid conflicts.

For instance if the LAN network is translated from 192.168.0.0/24 to 192.168.147.0/24, the device with the address 192.168.0.3 can be reached by the remote maintenance PC at 192.168.147.3.

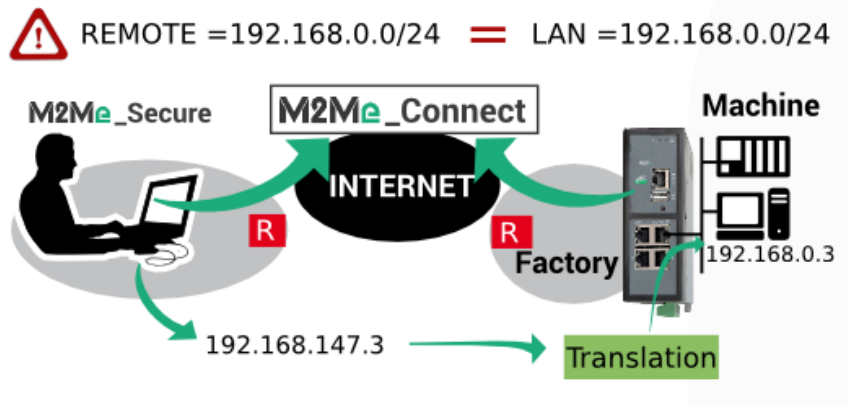

Security

The Factory network and the Machine network are separated by the RAS; the firewall can operate to filter exchanges between these two networks.

By default, the Machine devices are protected from unexpected exchanges initiated by any equipment connected to the Factory network. Exchanges initiated by a Machine device are allowed. This situation can be modified by setting up the firewall.

The remote user can only access the explicitly declared devices.

Warning: a user without access rights will not be able to access anything.

3 Use case 2

<p>The machine belongs to the Factory network. All the Machine devices belong to the Factory IP network. The machine is connected to the Internet via the Factory network. <u>The RAS is also connected to the Factory network through its LAN interface.</u></p>	<p>The diagram illustrates a network configuration. On the left, a black oval labeled 'INTERNET' is connected to a box labeled 'M2Me_Connect'. A green arrow points from the 'INTERNET' area towards a central grey oval representing the local network. Inside this oval, there is a 'Factory' section with three blue server icons and a 'Machine' section with a computer icon. A 'LAN' switch is shown connecting the Factory and Machine sections. A red 'R' icon is placed near the connection point between the Internet and the local network.</p>
---	--

Models	Internet access	Internet interface	Machine interface
Any models	Factory or company network	Ethernet LAN	Depending on models : Directly to the Factory switch Serial interface

Rules for assigning IP addresses:

The network IP address of the Machine and the network IP address of remote PC must be different.
 If both network IP address are identical, a network address translation is needed to avoid conflicts.

Security



The IP Factory network and the Machine network are merged; as a result, all devices connected to the local network are remotely accessible. This is why it is important to define strictly the authorized devices and the access rights. Do not give the user access right to **All the devices**.

Warning: a user without access rights will not be able to access anything.

USING THE WIZARD

4 Use case 3

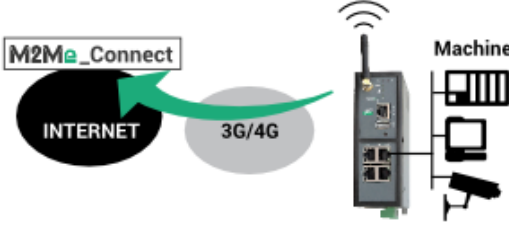
<p>The machine is connected to the Internet via a cellular network. Depending on models, 4G, 3G+ or GPRS connections are supported.</p>	 <p>The diagram illustrates the network architecture. On the left, a black circle labeled 'INTERNET' is connected to a grey circle labeled '3G/4G'. A green arrow labeled 'M2Me_Connect' points from the '3G/4G' network to the 'INTERNET'. On the right, a 'Machine' is shown with a cellular antenna and a computer monitor, connected to the '3G/4G' network.</p>
--	--

Models	Internet access	Internet interface	Machine interface
RAS-EC RAS-ECW	Cellular network	Cellular antenna	Depending on models : Ethernet LAN Serial interface

Rules for assigning IP addresses:

The network IP address of the Machine and the network IP address of remote PC must be different.
If both network IP address are identical, the devices IP address of the machine must be modified or a network address translation is needed to avoid conflicts.

Security:

The remote user can only access the explicitly declared devices.

The availability and the quality of a cellular network is sometimes lower than a company network internet access. It is important to check this situation will not provoke any kind of danger for people on the machine site or of any other kind.

Warning: a user without access rights will not be able to access anything.

5 Use case 4

<p>The machine is connected to the Internet via a Wi-Fi network. The Wi-Fi interface of the RAS is used to access Internet (Wi-Fi client), it cannot be used at the same time as an access point (for example to connect a tablet).</p>	
---	--

Models	Internet access	Internet interface	Machine interface
RAS-EW RAS-ECW	Factory Wi-Fi network	Wi-Fi antenna	Depending on models : Ethernet LAN Serial interface

Rules for assigning IP addresses:

The network IP address of the Machine and the network IP address of the Factory Wi-Fi must be different.
 If both network IP address are identical, the devices IP address of the machine must be modified.

The network IP address of the Machine and the network IP address of remote PC must be different.
 If both network IP address are identical, the devices IP address of the machine must be modified or a network address translation is needed to avoid conflicts.

Security

The Factory Wi-Fi network and the Machine network are separated by the RAS; the firewall can operate to filter exchanges between these two networks.

By default, the Machine devices are protected from unexpected exchanges initiated by any equipment connected to the Factory network. Exchanges initiated by a Machine device are allowed. This situation can be modified by setting up the firewall.

The remote user can only access the explicitly declared devices.

Warning: a user without access rights will not be able to access anything.

6 Use case 5

<p>The machine is connected to the Internet via the Factory network and, if it is not available, via a cellular network. Reaching the Internet through the Factory network may not be immediately authorized or available at the machine installation time; it is the reason why, the RAS is able to select the available way to the Internet; the Factory network is selected as a priority and the cellular network is used as a backup solution. The RAS switches automatically between that both ways.</p>	
--	--

Models	Internet access	Internet interface	Machine interface
RAS-EC RAS-ECW	Factory or company network	Ethernet WAN	Depending on models : Ethernet LAN
	Cellular network	Cellular antenna	Serial interface

Rules for assigning IP addresses:

The network IP address of the Machine and the network IP address of the Factory must be different.
 If both network IP address are identical, the devices IP address of the machine must be modified.

The network IP address of the Machine and the network IP address of remote PC must be different.
 If both network IP address are identical, the devices IP address of the machine must be modified or a network address translation is needed to avoid conflicts.

Security

The Factory network and the Machine network are separated by the RAS; the firewall can operate to filter exchanges between these two networks.

By default, the Machine devices are protected from unexpected exchanges initiated by any equipment connected to the Factory network. Exchanges initiated by a Machine device are allowed. This situation can be modified by setting up the firewall.

The remote user can only access the explicitly declared devices.

Warning: a user without access rights will not be able to access anything.

7 Use case 6

The machine is connected to the Internet via the Wi-Fi network and, if it is not available, via a cellular network.
 Reaching the Internet through the Factory network may not be immediately authorized or available at the machine installation time; it is the reason why, the RAS is able to select the available way to the Internet; the Wi-Fi Factory network is selected as a priority and the cellular network is used as a backup solution. The RAS switches automatically between that both ways.

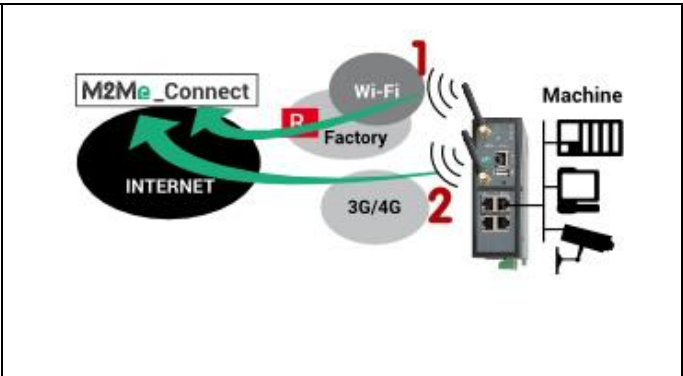

Models	Internet access	Internet interface	Machine interface
RAS-ECW	Factory Wi-Fi network	Wi-Fi antenna	Depending on models : Ethernet LAN Serial interface
	Cellular network	Cellular antenna	

Rules for assigning IP addresses:
The network IP address of the Machine and the network IP address of the Factory Wi-Fi must be different.
 If both network IP address are identical, the devices IP address of the machine must be modified.

The network IP address of the Machine and the network IP address of remote PC must be different.
 If both network IP address are identical, the devices IP address of the machine must be modified or a network address translation is needed to avoid conflicts.

Security

The Factory Wi-Fi network and the Machine network are separated by the RAS; the firewall can operate to filter exchanges between these two networks.
 By default, the Machine devices are protected from unexpected exchanges initiated by any equipment connected to the Factory network. Exchanges initiated by a Machine device are allowed. This situation can be modified by setting up the firewall.
 The remote user can only access the explicitly declared devices.
 Warning: a user without access rights will not be able to access anything.

8 Example: Access to the Internet via the Ethernet WAN network

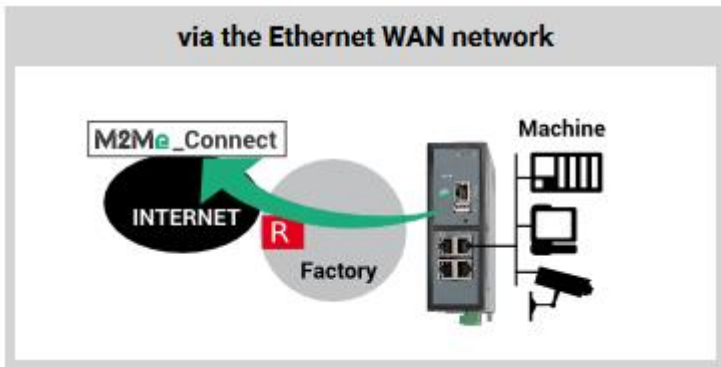

etic
TELECOM

RAS-ECW-220
site de demo RAS-ECW

Documentation | EN | FR

M2Me
Configuration wizard

- 1. Use cases
- 2. **M2Me connection**
- 3. Machine network
- 4. Remote users
- 5. Summary

Ethernet WAN IP settings

- Obtain an IP address automatically
- Obtain DNS servers addresses automatically

← Prev exit Next →

etic
TELECOM

RAS-ECW-220
site de demo RAS-ECW

Documentation | EN | FR

M2Me
Configuration wizard

- 1. Use cases
- 2. **M2Me connection**
- 3. Machine network
- 4. Remote users
- 5. Summary

Proxy server for Internet access

- Direct access to the Internet (no proxy)

← Prev exit Next →



RAS-ECW-220
site de demo RAS-ECW

Documentation | EN | FR

M2Me
Configuration wizard

1. Use cases
2. M2Me connection
- 3. Machine network**
4. Remote users
5. Summary

LAN IP settings

⚠ LAN and WAN IP networks must be different.

	IP address	192.168.3.2
	Netmask	255.255.255.0

⚠ Are the LAN and the remote maintenance PC IP networks identical ? No

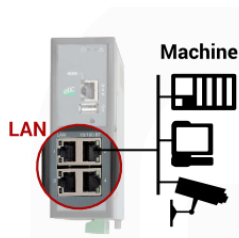

← Prev
exit
Next →



RAS-ECW-220
site de demo RAS-ECW

Documentation | EN | FR

M2Me
Configuration wizard

1. Use cases
2. M2Me connection
- 3. Machine network**
4. Remote users
5. Summary

Devices list

Devices creation is not mandatory.

Nevertheless it is required for:

- restrictive access rights definition
- device presence diagnostic
- WEB portal generation

Devices list

	Name	IP Address
<input checked="" type="radio"/>	PLC	192.168.3.55
<input type="radio"/>	HMI Panel	192.168.3.56

← Prev
exit
Next →



RAS-ECW-220
site de demo RAS-ECW

Documentation | EN | FR

M2Me
Configuration wizard

1. Use cases
2. M2Me connection
- 3. Machine network**
4. Remote users
5. Summary

> Add a new device / subnet

Enter an IP address as xxx.xxx.xxx.xxx for one device or as xxx.xxx.xxx.xxx/yy (IP/Netmask) for a subnet

	Name	
	IP Address	

← Prev
exit
Next →



RAS-ECW-220
 site de demo RAS-ECW

Documentation | EN | FR

M2Me
Configuration wizard

1. Use cases
2. M2Me connection
3. Machine network
4. Remote users
5. Summary

Remote users list

⚠ Creation of at least one remote user is required

Users list

Active	Full name	E-mail adress	Company	Phone number (International format : +33611223344)
Show Edit Delete Add ... Copy and edit ⌵ ⌶				

← Prev exit Next →



RAS-ECW-220
 site de demo RAS-ECW

Documentation | EN | FR

M2Me
Configuration wizard

1. Use cases
2. M2Me connection
3. Machine network
4. Remote users
5. Summary

> User Configuration

User information

Active	<input checked="" type="checkbox"/>
Full name	<input type="text" value="Pierre DUPONT"/>
Company	<input type="text"/>
E-mail adress	<input type="text"/>
Phone number (International format : +33611223344)	<input type="text"/>
User name	<input type="text" value="dupont"/>
Password	<input type="password"/> <input type="password"/> Passwords match
Password strength	too short

For security reasons, choose a password longer than 8 characters with uppercase and lowercase letters, numbers and special characters

Access rights

Select on the table below the devices and services the user will be authorized to access.

Authorize	Device	Services
<input type="checkbox"/>	All the devices	+ All
<input type="checkbox"/>	All devices on the LAN	+ All
<input type="checkbox"/>	All devices on the additional LAN	+ All
<input checked="" type="checkbox"/>	This device	+ All
<input checked="" type="checkbox"/>	PLC	+ All
<input checked="" type="checkbox"/>	HMI Panel	+ All

← Prev exit Next →



RAS-ECW-220
site de demo RAS-ECW

Documentation | EN | FR

M2Me
Configuration wizard

1. Use cases
2. M2Me connection
3. Machine network
4. Remote users
5. Summary

Remote users list

Creation of at least one remote user is required

Users list

	Active	Full name	E-mail adress	Company	Phone number (International format : +33611223344)
<input checked="" type="radio"/>	Yes	Pierre DUPONT			

← Prev
exit
Next →



RAS-ECW-220
site de demo RAS-ECW

Documentation | EN | FR

M2Me
Configuration wizard

1. Use cases
2. M2Me connection
3. Machine network
4. Remote users
5. Summary

Configuration summary

The configuration wizard is finished. Click on "Apply configuration" to validate the modifications or on "exit" to discard it.

- Wan IP : auto
- Proxy disabled
- 2 devices created
- 1 user created
- Lan IP: 192.168.3.2

Apply configuration

← Prev
exit
Next →

ADVANCED SETUP

The main purpose of the wizard is to facilitate the connection of the RAS to the Internet. The advanced setup mode is used to implement both basic functions (usually setup by the wizard) and additional functions if necessary.

The access to the advanced setup is via the menu on the left side of the home page.

Function	Menu
Internet connection set-up Ethernet WAN Cellular network Wi-Fi network (the RAS is a Wi-Fi client)	WAN interfaces
LAN interface set-up The Ethernet & IP setup of the RAS LAN interface The IP addresses of the devices of the machine	LAN Interface
Remote access set-up The M2Me connection The remote users Their access rights	Remote access
IP routing VPNs Static routes RIP Address translation Port forwarding DynDNS or NoIP	Network
Filtering the data-flow between the LAN interface on one hand and the WAN and VPN interfaces on the other hand	Security > Firewall
Serial gateway set-up	Serial gateways
Email or SM Alarm	System > SMS/e-mail
Administration web server access	Security > Administration rights

For details about the advanced setup, refer to the Routing Setup Guide:
 Reference: DOC_DEV_Router Setup Guide



13, Chemin du Vieux Chêne
38240 Meylan - France

Tel : +33 (0)4 76 04 20 00
contact@etictelecom.com

www.etictelecom.com