

GW-R4513 User Manual

File Version: V1.0.1



Contents

GW-R4513 User Manual	1
1. Get Start	4
1.1. Hardware Test	4
1.2. Net Connection.....	4
1.3. Router Initial Value	4
2. Product Overview.....	5
2.1. Product Introduction.....	5
2.2. Function.....	5
2.3. Basic Function.....	6
2.4. Product Dimensions.....	8
3. Produce Function	10
3.1. Configuration Process	11
3.2. Interconnection of GW-R4513	12
3.2.1. WAN+4G.....	12
3.2.2. Double LAN+4G.....	13
3.3. Basic Function.....	14
3.3.1. Network Diagnostic Function	14
3.3.2. Host Name and Time Zone.....	15
3.3.3. Password Setting	16
3.3.4. Reset to Default.....	16
3.3.5. Indicator Light.....	17
3.3.6. Firmware Upgrade.....	18
3.3.7. Reboot	19
3.4. Advanced Function	19
3.4.1. Supported Services.....	19
3.4.2. WiFiDog.....	20
3.4.3. LAN Interface	23
3.4.4. DHCP Function	25
3.4.5. WAN Interface.....	26
3.4.6. Wi-Fi Wireless Interface.....	26
3.4.7. 4G Interface.....	29
3.4.8. APN Setting	31
3.4.9. VPN Client(PPTP/LTP/GRE/OPENVPN).....	32
3.4.9.1. PPTP Client	32
3.4.9.2. L2TP Client	34
3.4.9.3. IPSEC.....	36
3.4.9.4. OPENVPN	37
3.4.9.5. GRE.....	41
3.4.9.6. SSTP Client	43
3.4.10. Static Router.....	44
3.4.11. NAT Function.....	44
3.4.11.1. MASQ	44

3.4.11.2.	SNAT	44
3.4.11.3.	DNAT	46
3.4.12.	Access Restrictions	49
3.4.12.1.	Domain Blacklist	49
3.4.12.2.	Whitelist	49
3.4.13.	Rate Limiting	50
4.	DTU Function	51
4.1.	Work Mode.....	52
4.1.1.	Net Transparent Transmission Mode.....	53
4.1.1.1.	Mode Declaration	53
4.1.2.	HTTPD Mode.....	55
4.1.2.1.	Mode Declaration	55
4.1.3.	UDC Mode.....	57
4.1.3.1.	Mode Declaration	57
4.2.	Serial Port.....	59
4.2.1.	Basic Parameters	59
4.2.2.	Frame Forming Mechanism	59
4.2.2.1.	Time Triggered Mode.....	59
4.2.2.2.	Length Triggered Mode.....	60
4.3.	Characteristic Functions	61
4.3.1.	Registration Package	61
4.3.2.	Heartbeat Package.....	63
4.3.3.	USR-Cloud.....	64
5.	Webpage Sitting	66
5.1.	Web Function	67
6.	AT Commands.....	69
7.	Contact Us.....	72
8.	Disclaimer	72
9.	Update History	72

1. Get Start

GW-R4513 is a 4G wireless router with powerful DTU function, which provides users with an integrated solution of 4G router and DTU.

1.1. Hardware Test



Figure 1 hardware connection

1.2. Net Connection

- Insert SIM card
- Install WIFI antenna, M2M antenna
- Connect PC to the LAN port of GW-R4513
- Set PC to get dynamic IP
- Power on GW-R4513
- Wait for about a minute, and the 2/3G indicator lights up, indicating that the router's 4G network is successful and can be connected to the Internet.

1.3. Router Initial Value

Table 1 router initial value

Parameter	Initial value
Account	root
Password	root
IP address	192.168.1.1

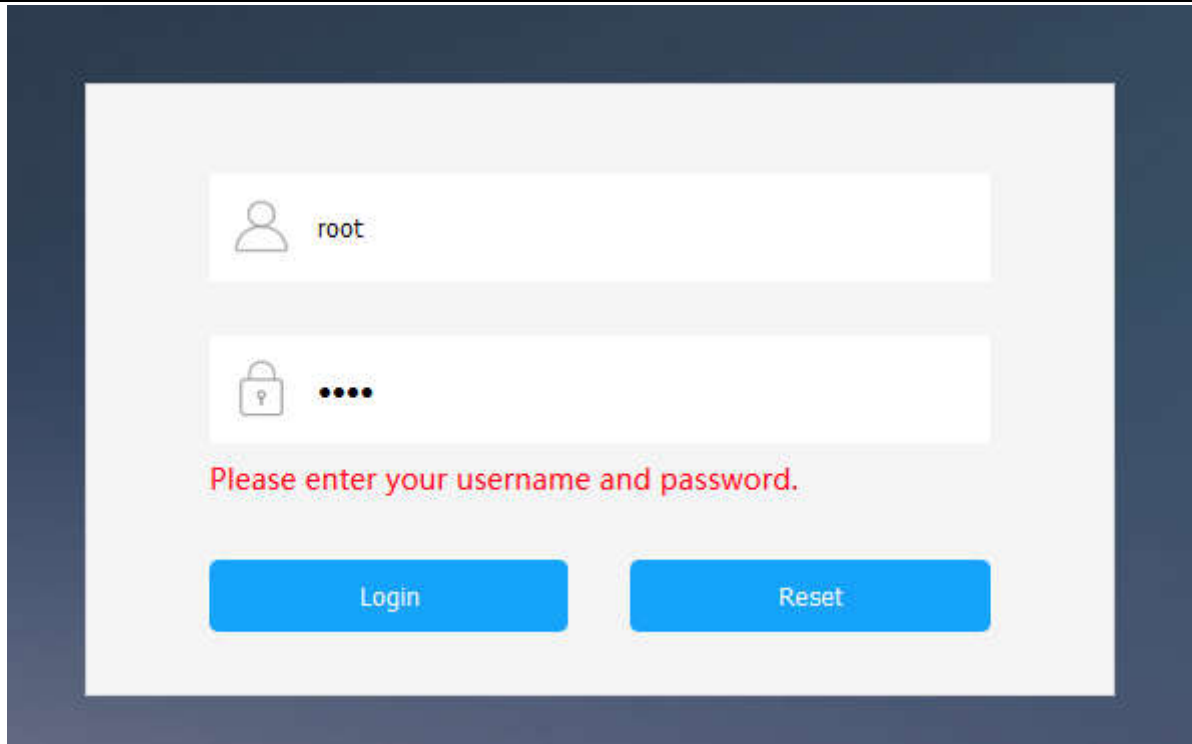

Figure 2 webpage

2. Product Overview

2.1. Product Introduction

GW-R4513 is a 4G wireless router with powerful DTU functions, providing users with an industrial 4G router and DTU integration solution.

It adopts the high-performance embedded structure of the industry, and provides reliable data transmission network for the data transmission fields of smart home, smart grid, personal medical, industrial control and so on.

Support wired WAN ports, LAN ports, wireless WLAN network, 4G network interface, rich and diverse networking functions, easy for users to lay their own network.

2.2. Function

- Support 1 wired LAN ports, 1 wired WAN ports (WAN ports can be switched to LAN ports).
- Support 1 WIFI wireless LAN
- Support multiple LED communication indicators
- Support SSH, TELNET, Web multi platform management configuration mode.
- Support one button to restore factory settings.
- The wired net ports support 10/100Mbps rate.
- Support VPN Client (PPTP/L2TP/IPSEC/GRE/OPENVPN/SSTP) and supports VPN encryption and static IP functions.
- Support APN automatic checking network, 2/3/4G system switching, SIM information display, support

APN/VPDN special network card.

- Support for wired wireless multi network simultaneous online and multi network intelligent switching backup function
- Support remote upgrade and remote monitoring.
- Support Dynamic Domain Name System (DDNS), Static Routing, PPPOE, DHCP, Static IP Function
- Support mandatory portal (WIFIDOG), this function needs to be customized according to customer needs.
- Support the firewall, NAT, DMZ host, access control black-and-white list, IP speed limit, NTP, MAC speed limit.
- Support SMS AT command
- Support 4 network connections online, support TCP Server, TCP Client, UDP Server and UDP Client
- Every connection supports 20KB serial data cache. When connection is abnormal, cached data can't be lost.
- Support for sending registration package / heartbeat data.
- Support network transmission mode, HTTPD mode, UDC mode and USR-Cloud.
- Support basic instruction set
- Support external hardware watchdog design to ensure system stability.

2.3. Basic Function

Table 2 parameter

Wireless parameters (-AU module)		
Standard	TD-LTE	
	FDD-LTE	
	WCDMA	
	TD-SCDMA	
	GSM/GPRS/EDGE	
Frequency band standard	TD-LTE	Band 40
	FDD-LTE	Band 1/2/3/4/5/7/8/28
	WCDMA	Band 1/2/5/8
	GPRS	Band 2/3/5/8
Emissive power	TD-LTE	+23dBm(Power class 3)
	FDD-LTE	+23dBm(Power class 3)
	WCDMA	+23dBm(Power class 3)
	TD-SCDMA	+24dBm(Power class 2)
	GSM Band8	+33dBm(Power class 4)
	GSM Band3	+30dBm(Power class 1)
Technical specifications	TD-LTE	3GPP R9 CAT4 down 150 Mbps Up 50 Mbps
	FDD-LTE	3GPP R9 CAT4down150 Mbps Up 50 Mbps
	WCDMA	HSPA+ down 21 Mbps Up 5.76 Mbps
	TD-SCDMA	3GPP R9 down 2.8 Mbps

		Up 2.2 Mbps
	GSM/GPRS/EDGE	MAX: down 384 kbps up 128 kbps
Wireless parameters (-E module)		
Standard	TD-LTE	
	FDD-LTE	
	WCDMA	
	TD-SCDMA	
	EVDO/CDMA1X	
	GSM/EDGE	
Frequency band standard	TD-LTE	Band 38/40/41
	FDD-LTE	Band 1/3/5/7/8/20
	WCDMA	Band 1/5/8
	GPRS	Band 3/8
Emissive power	TD-LTE	+23dBm(Power class 3)
	FDD-LTE	+23dBm(Power class 3)
	WCDMA	+23dBm(Power class 3)
	TD-SCDMA	+24dBm(Power class 2)
	CDMA2000	+23dBm(Power class 3)
	GSM Band8	+33dBm(Power class 4)
	GSM Band3	+30dBm(Power class 1)
Technical specifications	TD-LTE	3GPP R9 CAT4 down 150 Mbp up 50 Mbps
	FDD-LTE	3GPP R9 CAT4 down 150 Mbp up 50 Mbps
	WCDMA	HSPA+ down 21 Mbps up 5.76 Mbps
	TD-SCDMA	3GPP R9 down 2.8 Mbps up 2.2 Mbps
	CDMA2000	down 3.1 Mbps up 1.8 Mbps
	GSM/EDGE	MAX: down 384 kbps up 128 kbps
Function		
DDNS	Support	
APN	Support	
VPN	Support	
Port mapping	Support	
Firewall	Support	
Intelligent backup	Support	
DTU	Support	
Net /WIFI		
LAN	1	

WAN	1
Net rate	10/100M
RS485	Support
Electromagnetic isolation protection	1.5KV
Automatic switching between crossover and direct connection	1.5KV
TBD	1
Power	
VCC	DC 9~36v
Working current	Average 270mA/max 400mA/12V
Power interface	DC
Power protection	Anti reverse connection
Interface	
Antenna	WIFI /4G antenna
Status lamp	signal intensity/4G/WIFI/LAN/WAN/power
Software	
V-COM	Windows(32/64 bit)
Setting method	Webpage, support SSH, telnet ,GW-R4513 setting software
Work environment	
Work temperature	-20~70 °C
Storage temperature	-40~+125°C
Storage humidity	1%~95%RH (non condensation)
Size	
Size	112.0 * 84.0* 28.0 mm(L*W*H)

2.4. Product Dimensions

Unit: mm

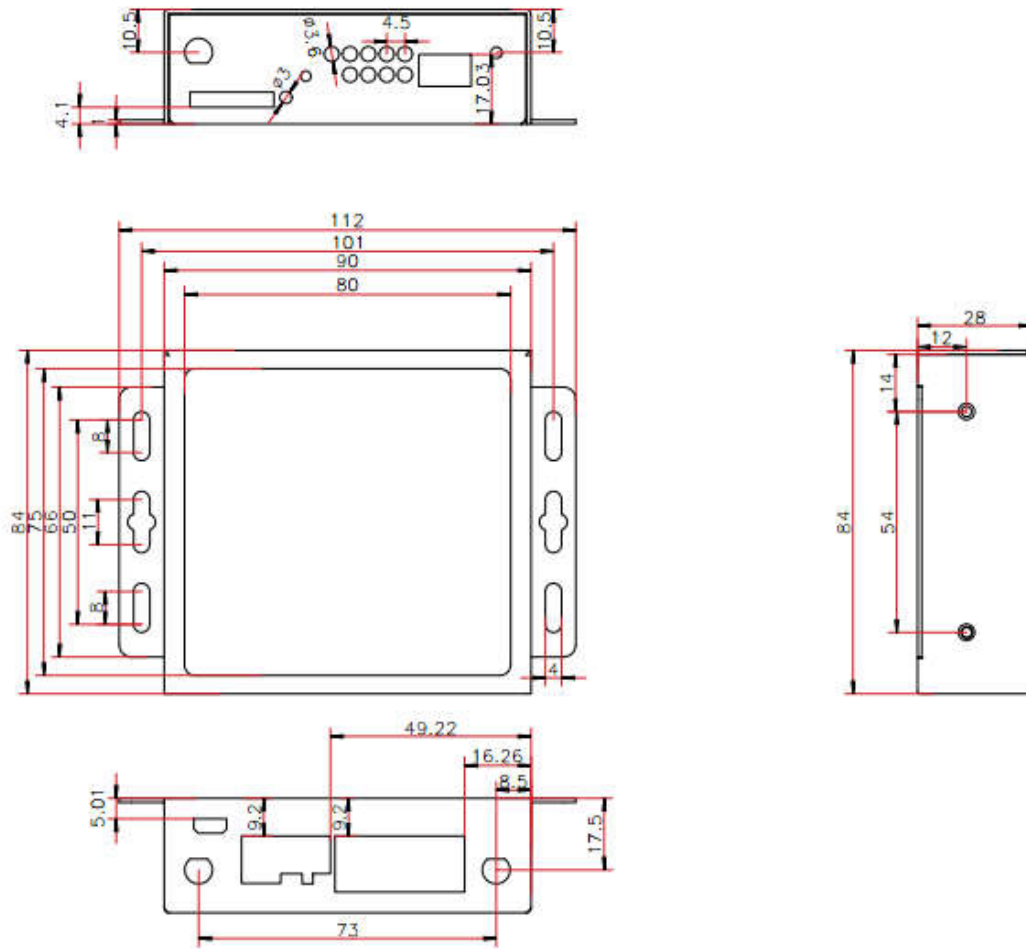

Figure 3 size

3. Produce Function

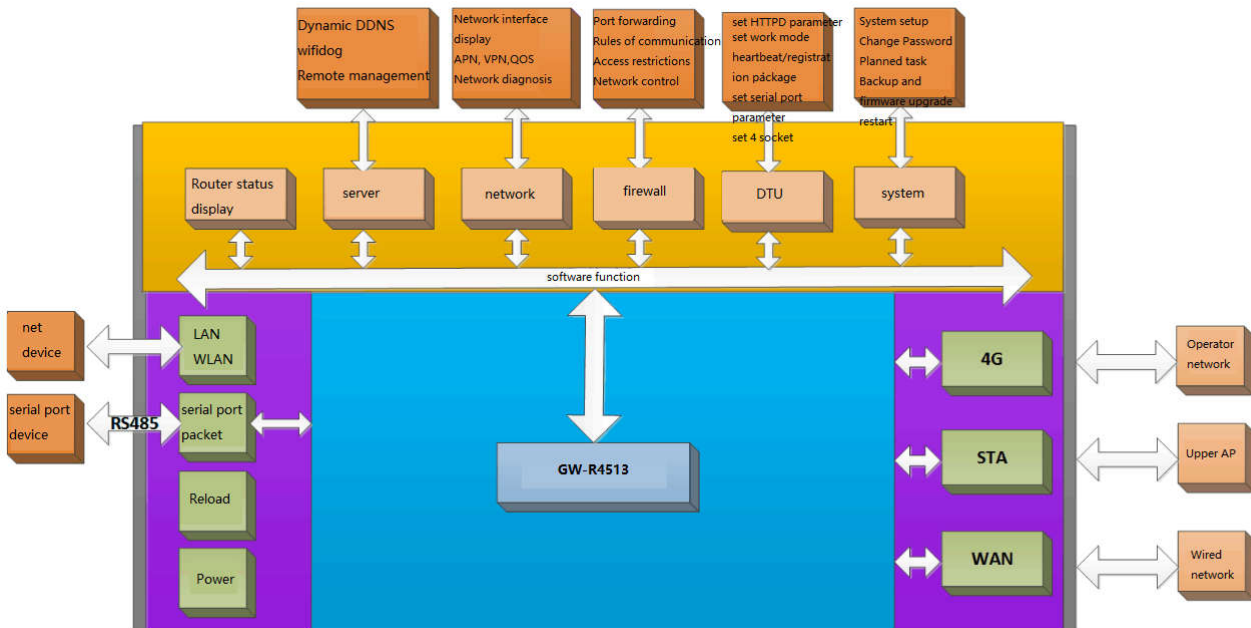

Figure 4 product function

3.1. Configuration Process

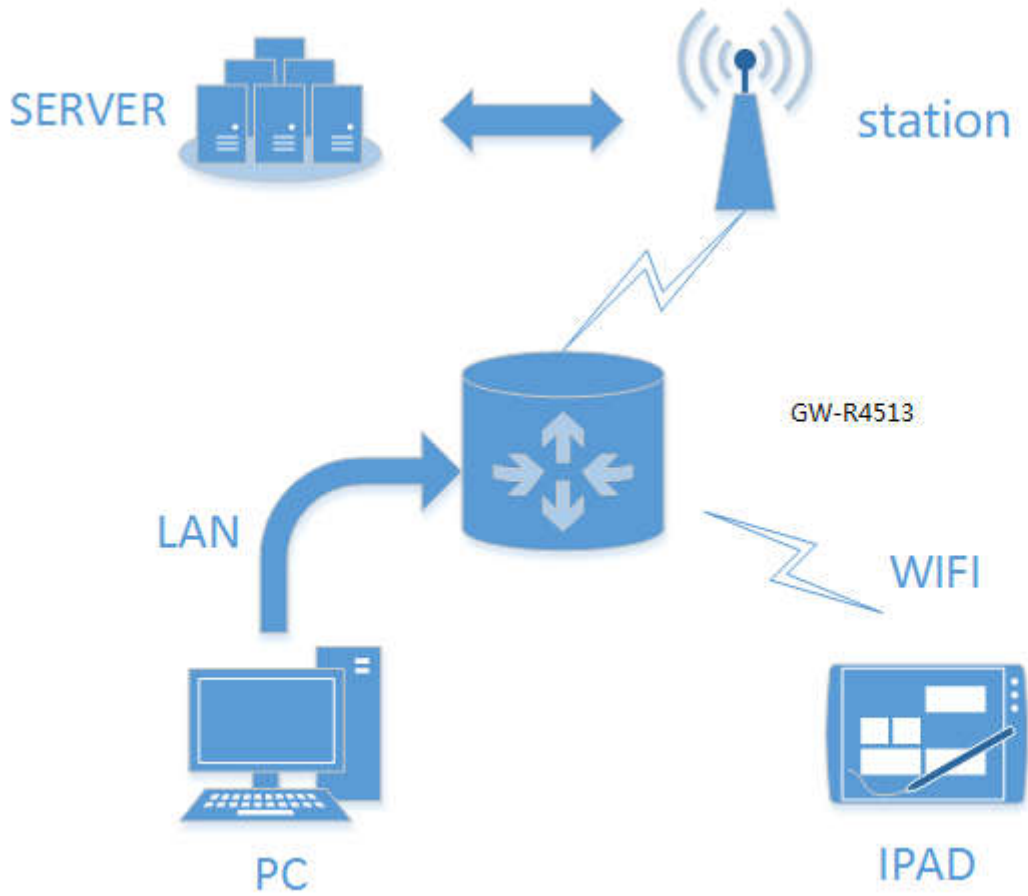

Figure 5 Schematic diagram of interconnection

3.2. Interconnection of GW-R4513

3.2.1.WAN+4G

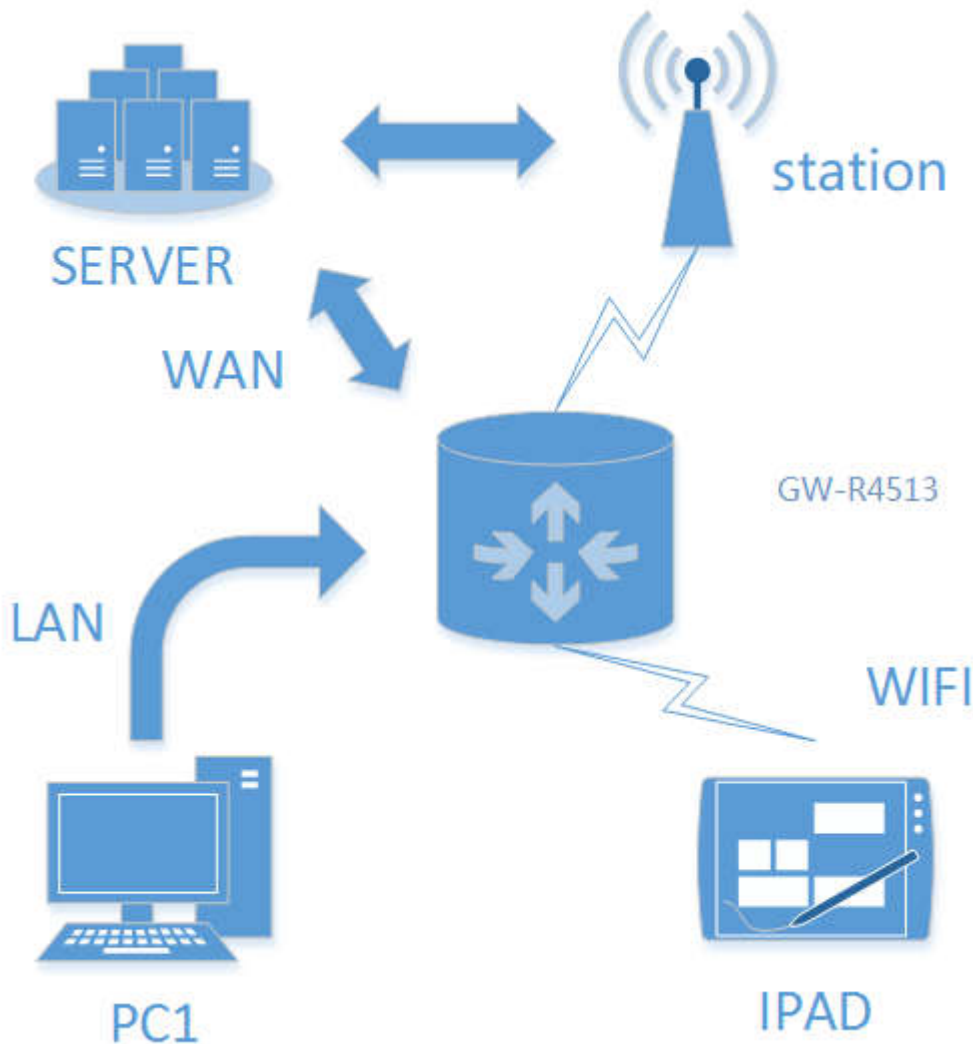

Figure 6 WAN+4G

This networking mode has two WAN ports (WAN ports of Ethernet port and 4G ports of M2M network) that can be connected to WAN simultaneously. The two channels form complementary and backup. At the same time, WAN ports of Ethernet port are preferred to ensure data fluency and save the traffic of 4G. When WAN ports are abnormal, they can't be connected to WAN. The router can also connect to the server through the 4G network port.

In this way, the router doesn't need any settings to connect to the network line, plug in 4G SIM card, and supply power to the router. The process of setting up customers is reduced to the greatest extent. Under this networking mode, the WIFI function of router can also work at the same time to maximize the number of LAN access.

This method is mainly used in the stably network, Such as factory buildings, intelligent buildings, smart cities and other related industries.

3.2.2. Double LAN+4G

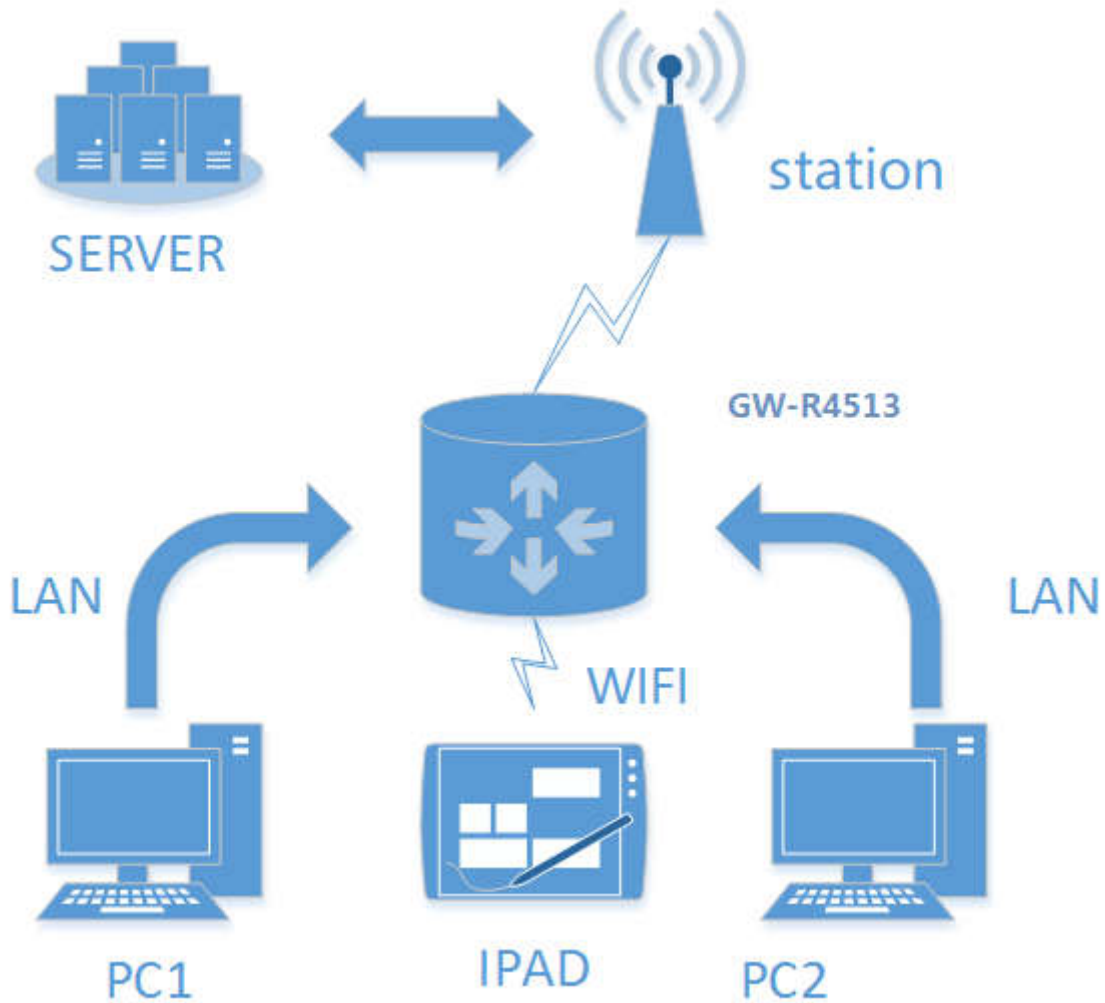

Figure 7 double LAN+4G

Set the two Ethernet port work as LAN port, the webpage is as follow,

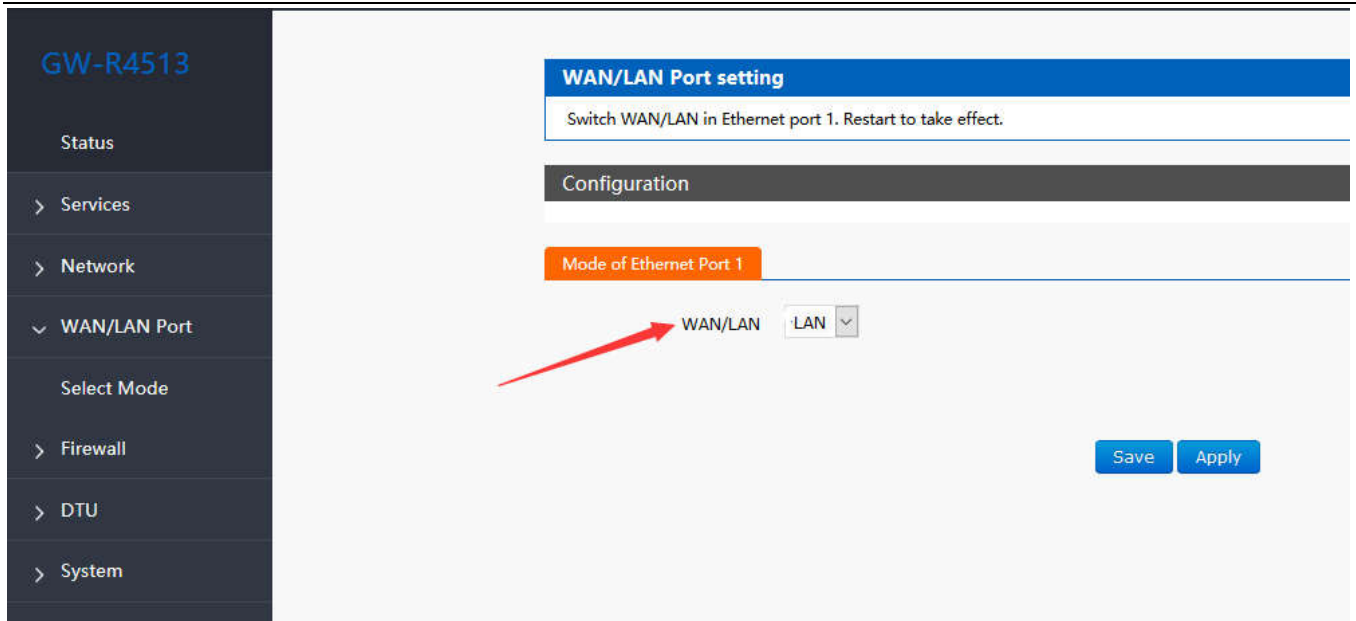

Figure 8 webpage setting

3.3. Basic Function

3.3.1. Network Diagnostic Function

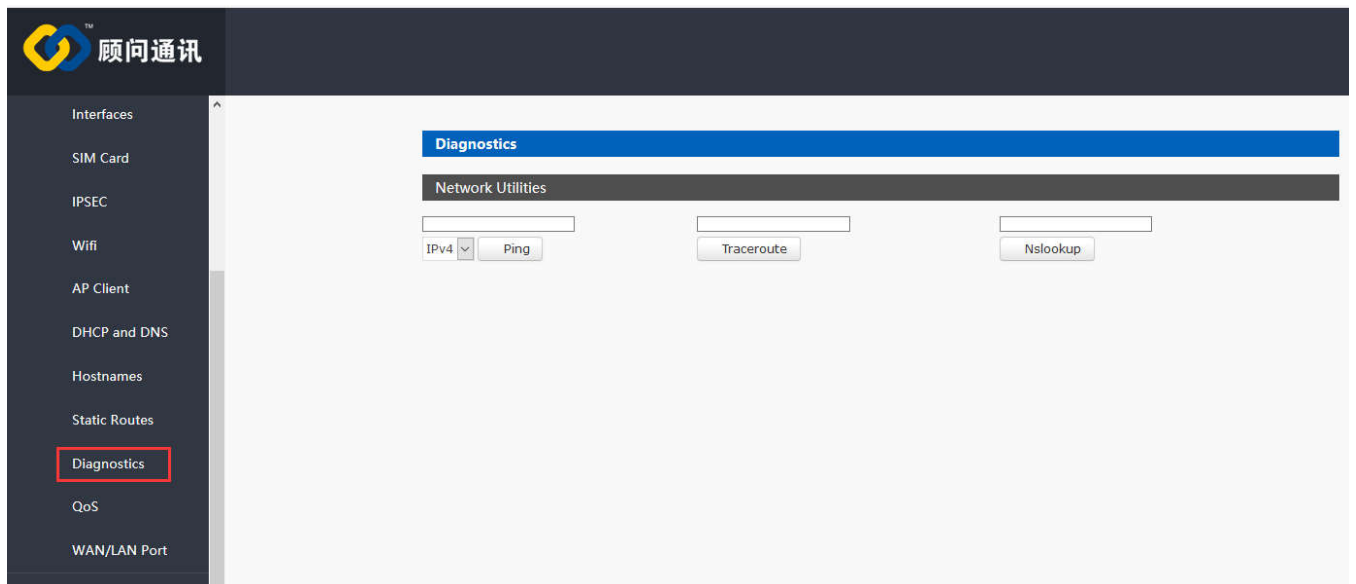
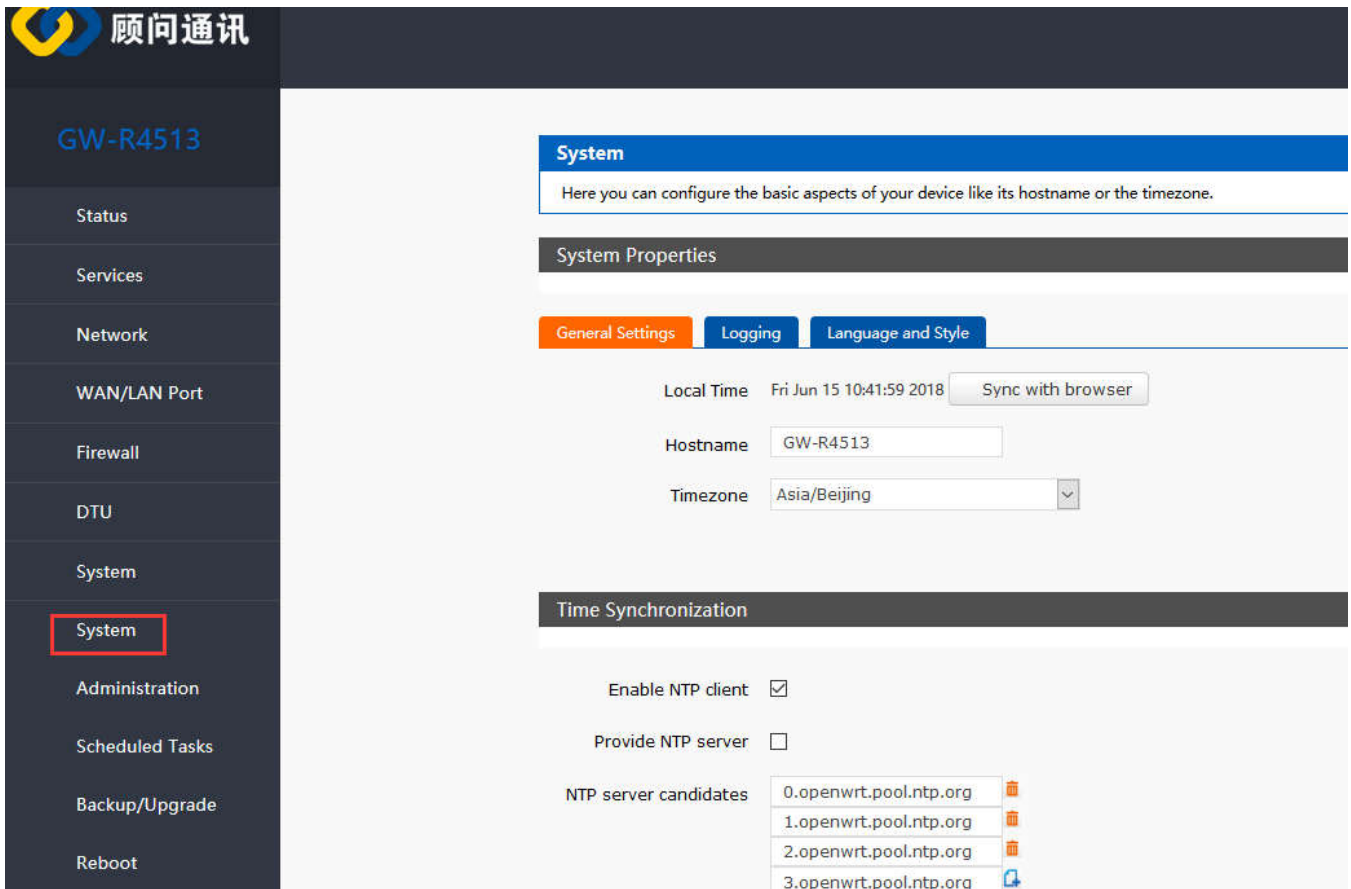

Figure9 the webpage of diagnostic

- Online diagnostic functions include Ping tools, routing parsing tools, and DNS View tools.
- Ping is a Ping tool, which can directly test Ping at a specific address on the router side.
- Traceroute is the routing parsing tool, which can get the routing path when accessing an address.
- Nslookup is a DNS view tool, which can resolve domain names to IP addresses.

3.3.2.Host Name and Time Zone



The screenshot displays the 'System' configuration page in the USR IOT web interface. On the left is a dark sidebar with a navigation menu. The main content area is titled 'System' and contains a description: 'Here you can configure the basic aspects of your device like its hostname or the timezone.' Below this is a 'System Properties' section with three tabs: 'General Settings' (selected), 'Logging', and 'Language and Style'. Under 'General Settings', there are three rows of configuration: 'Local Time' showing 'Fri Jun 15 10:41:59 2018' with a 'Sync with browser' button; 'Hostname' with a text input field containing 'GW-R4513'; and 'Timezone' with a dropdown menu set to 'Asia/Beijing'. Below these is a 'Time Synchronization' section with two checkboxes: 'Enable NTP client' (checked) and 'Provide NTP server' (unchecked). At the bottom, there is a list of 'NTP server candidates' with four entries: '0.openwrt.pool.ntp.org', '1.openwrt.pool.ntp.org', '2.openwrt.pool.ntp.org', and '3.openwrt.pool.ntp.org', each with a trash icon to its right.

Figure10 hostname and time zone

3.3.3.Password Setting

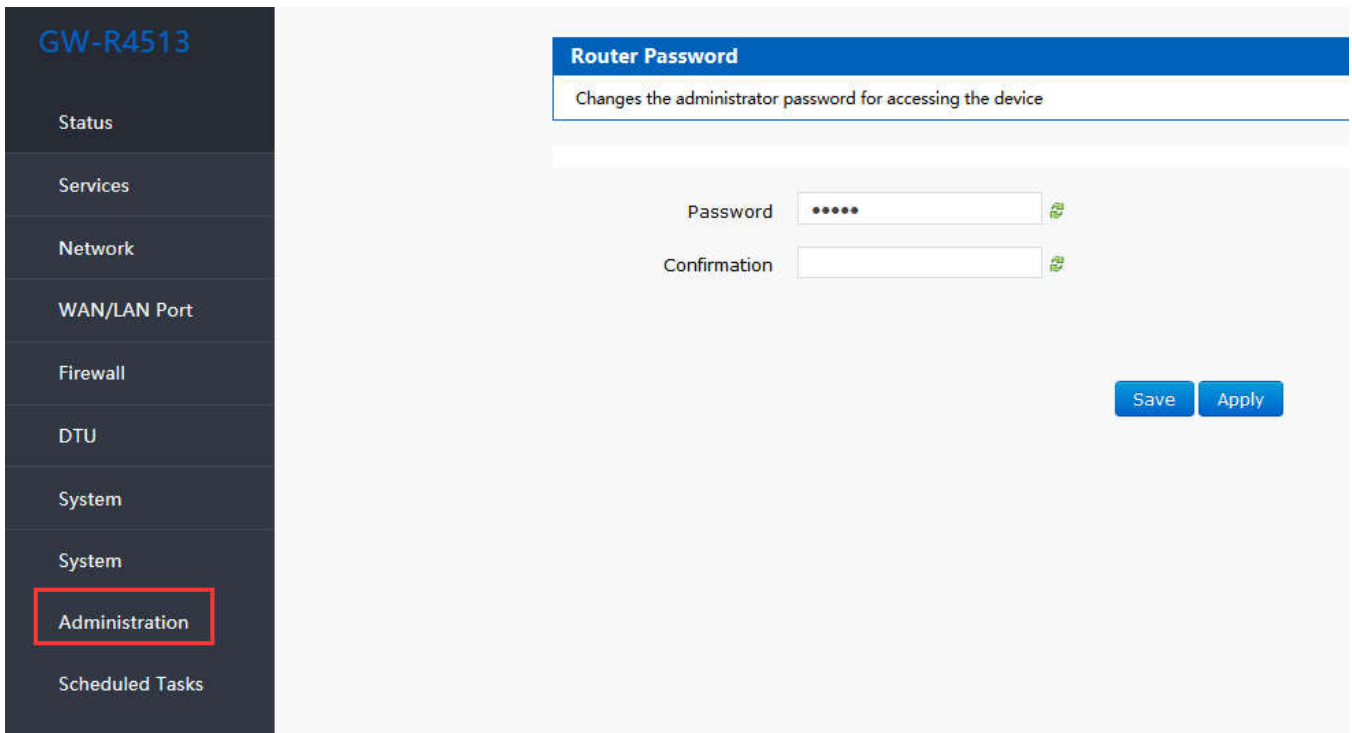

Figure11 the webpage of setting password

3.3.4.Reset to Default

You can restore factory parameter settings through web pages.

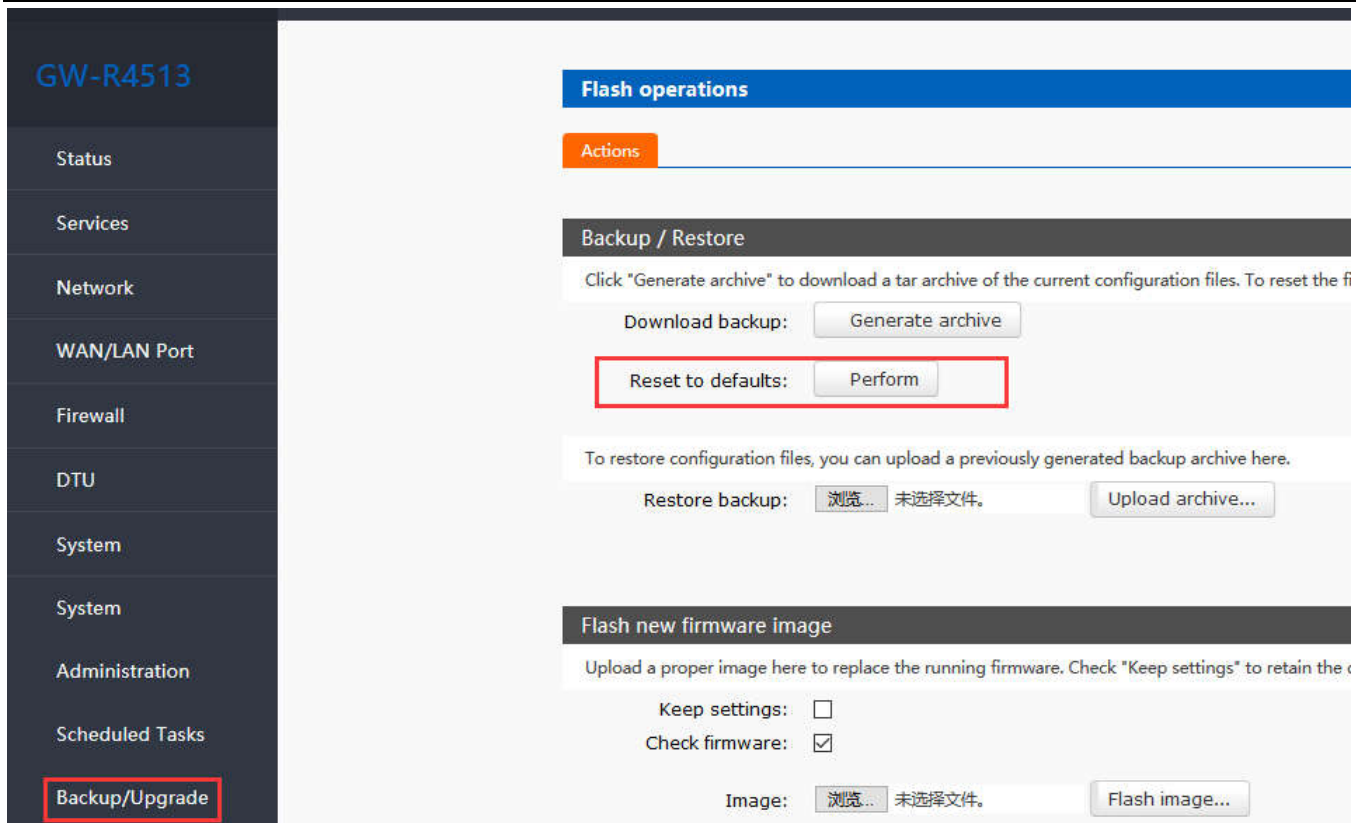

Figure12 the webpage of reset to default

Click the button to restore the factory settings. This function is consistent with the Reload button function of the hardware.

The use of Reload keys

- Long press 5S above and then release, the router will restore the factory parameter settings automatically and restart automatically.
- When the reboot takes effect, all the lights will be flashing 1 times and then destroyed.

3.3.5.Indicator Light

Table3 WIFI default parameter

Name	Intro
PWR	On when power on
WAN	On when use the WAN port, flicker when data transmission
LAN	On when use the LAN port, flicker when data transmission
WLAN	On when use WI-FI
2G indicator light	On when work on 2G
3G indicator light	On when work on 3G
Signal intensity (1-3)	The more, the stronger the signal is.

< Description >

- The 2/3/4G indicator lights up whether the GW-R4513 network is successful or not (the most important indicator).
- After WIFI starts successfully, the WLAN (or WIFI) indicator light on.
- The working conditions of WAN and LAN are indicated by WAN and LAN indicators.

- The corresponding WAN/LAN indicator flashes when the network line is connected and the network device working.
- The power lamp will always be bright.
- When the LTE module works at 4G, the 2G indicator and the 3G indicator light are all on.

3.3.6. Firmware Upgrade

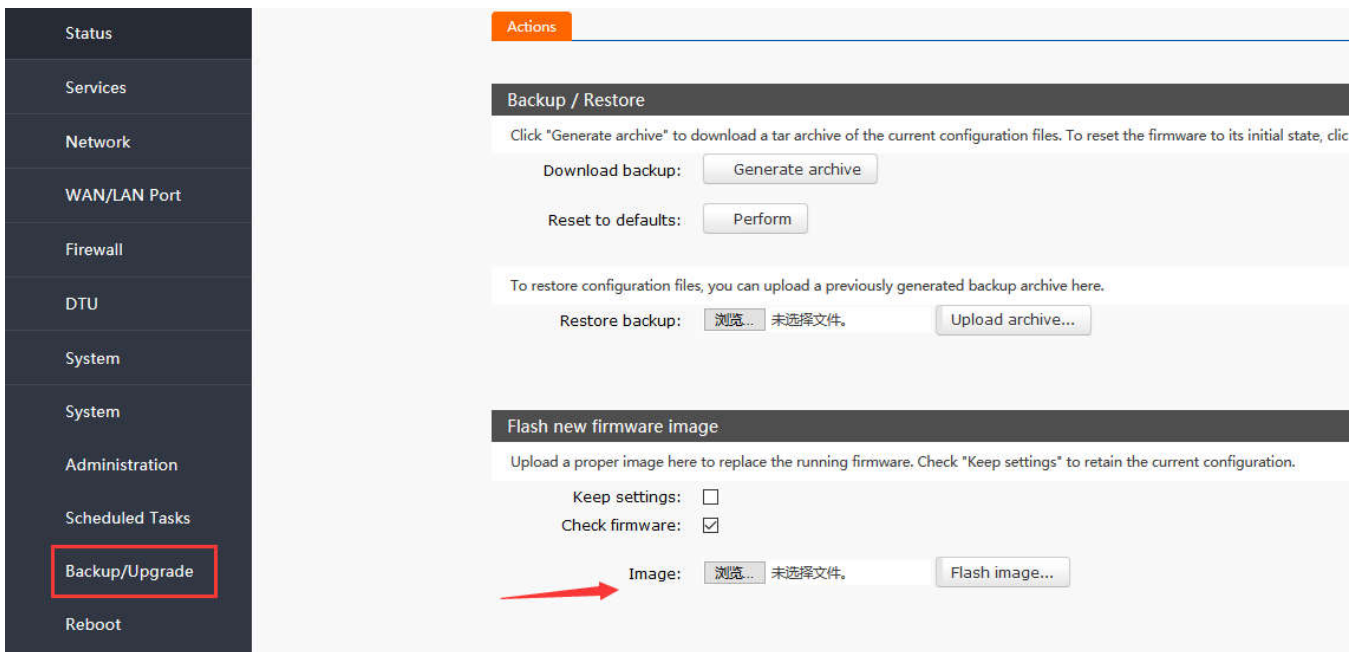

Figure13 the webpage of upgrade

< Description >

- The firmware upgrade process will last about 3-4 minutes. Please login again after 4 minutes.
- You can choose whether to save configuration.

During the process of firmware burning, please do not power down or unplug the wire.

3.3.7.Reboot

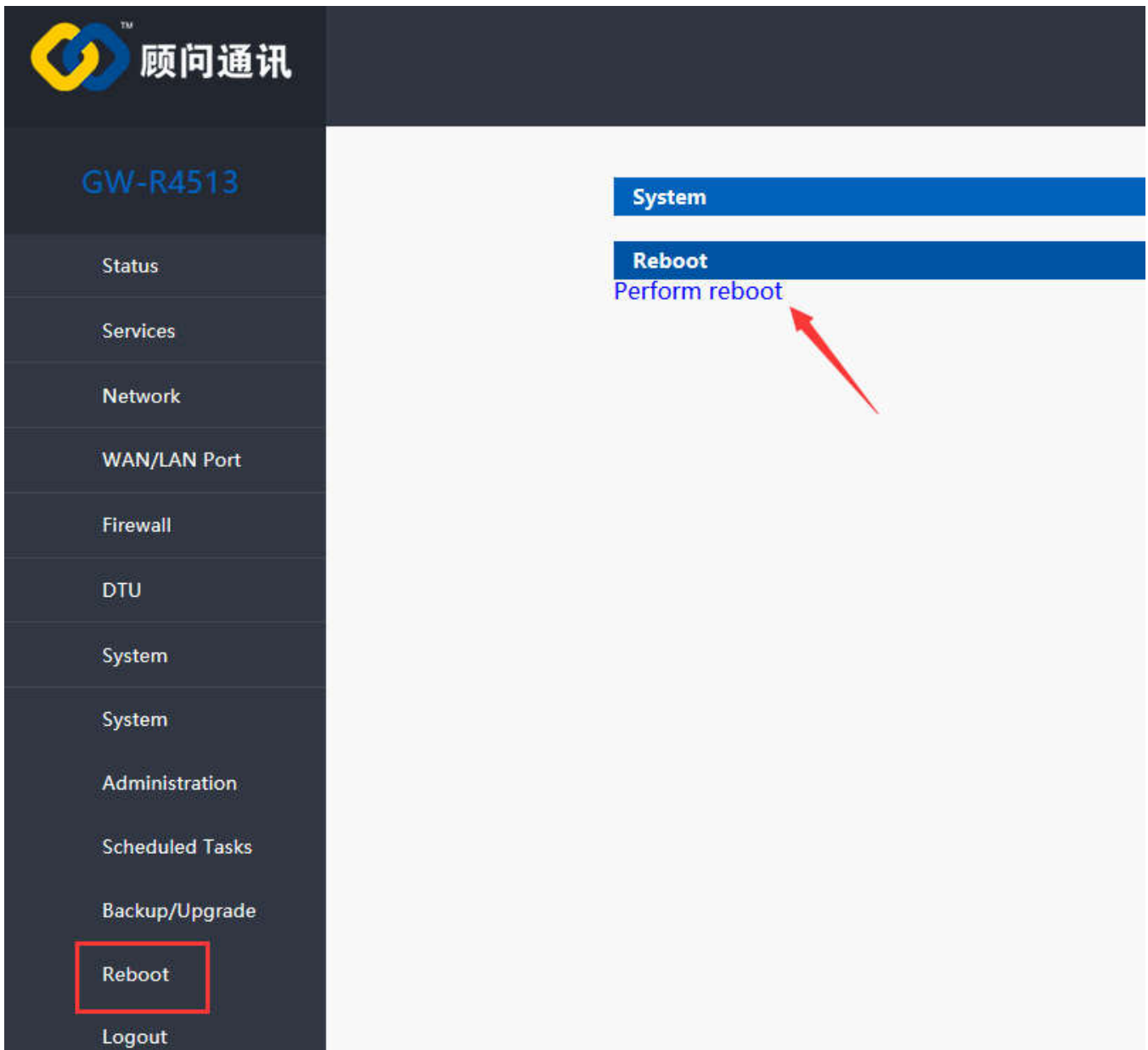

Figure14 the webpage of reboot

Click the button to restart the router.

The restart time is consistent with the router's power on startup time, which is about 40~60 seconds.

3.4. Advanced Function

3.4.1.Supported Services

The use of dynamic domain names can be divided into two situations. The first is that routers support DDNS.

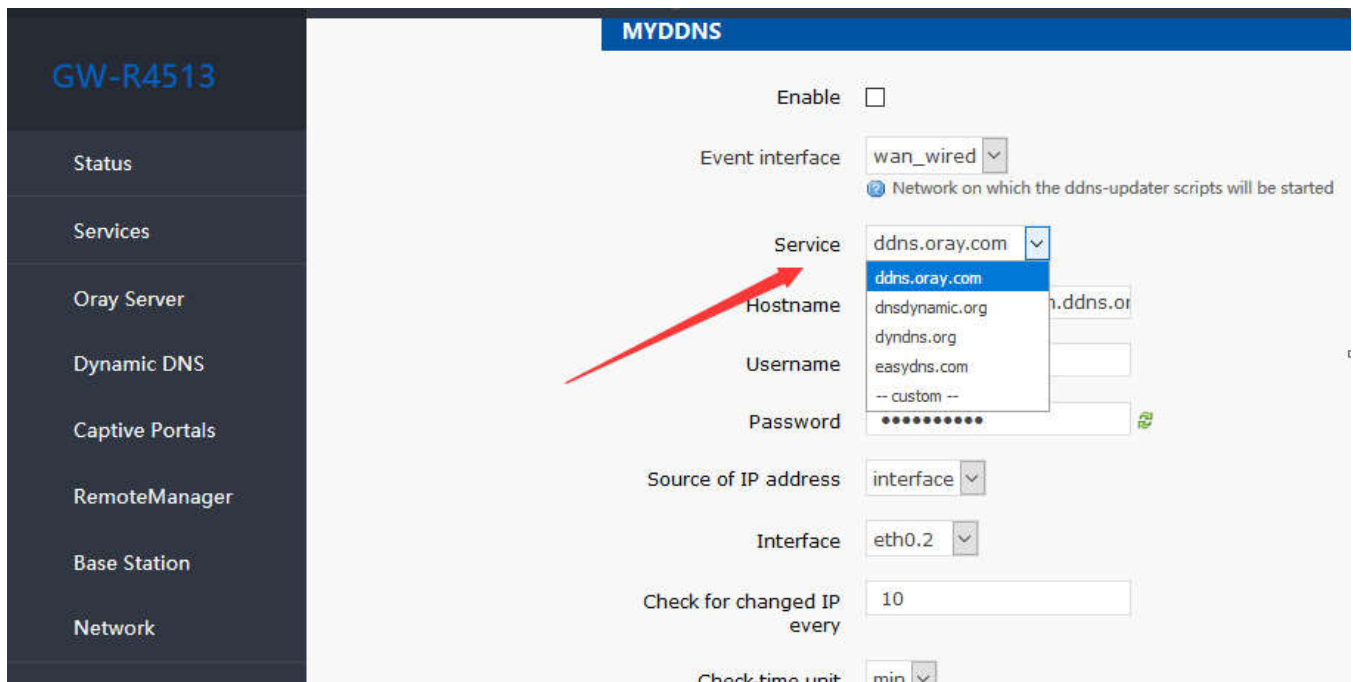
Figure15 the webpage of setting DDNS
Table4 DDNS custom server parameter

Function	Intro	Note
Enable	Enable/disable DDNS function	Default disable
Event interface	Choose the WAN port	e.g. choose wan_wired
Service/URL	Fill in the service address of DDNS.	e.g. http://ouclihuibin123:ouclihuibin1231@ddns.oray.com/ph/update?hostname=1a516r1619.iask.in
Hostname	Fill in the domain name	e.g. 1a516r1619.iask.in
User name	Fill in account name	e.g. ouclihuibin123
Password	Fill in password	e.g. ouclihuibin1231
Source of IP address	Choose the interface	
Interface	Choose the interface name	e.g. choose eth0.2
Check for changed IP/check-time unit	The interval between detecting IP address changes, domain name pointing to the IP may change frequently, the smaller the value, the more frequent the detection.	e.g. 1 min
Force update time /force-time unit	Mandatory update interval	e.g. 72 h

3.4.2.WiFiDog

Forced Portal (WiFiDog) allows devices accessing the router network to login to an authentication page for the first

time when browsing an extranet web page. Only when the authentication is successful can they access the extranet. The significance of mandatory portal function lies in the security of LAN network, recodeing illegal acts such as network attacks using public networks, in addition, it can also be used for advertising purposes, it collects customer information with the tacit consent of current broadband users, so as to facilitate manufacturers to promote marketing.

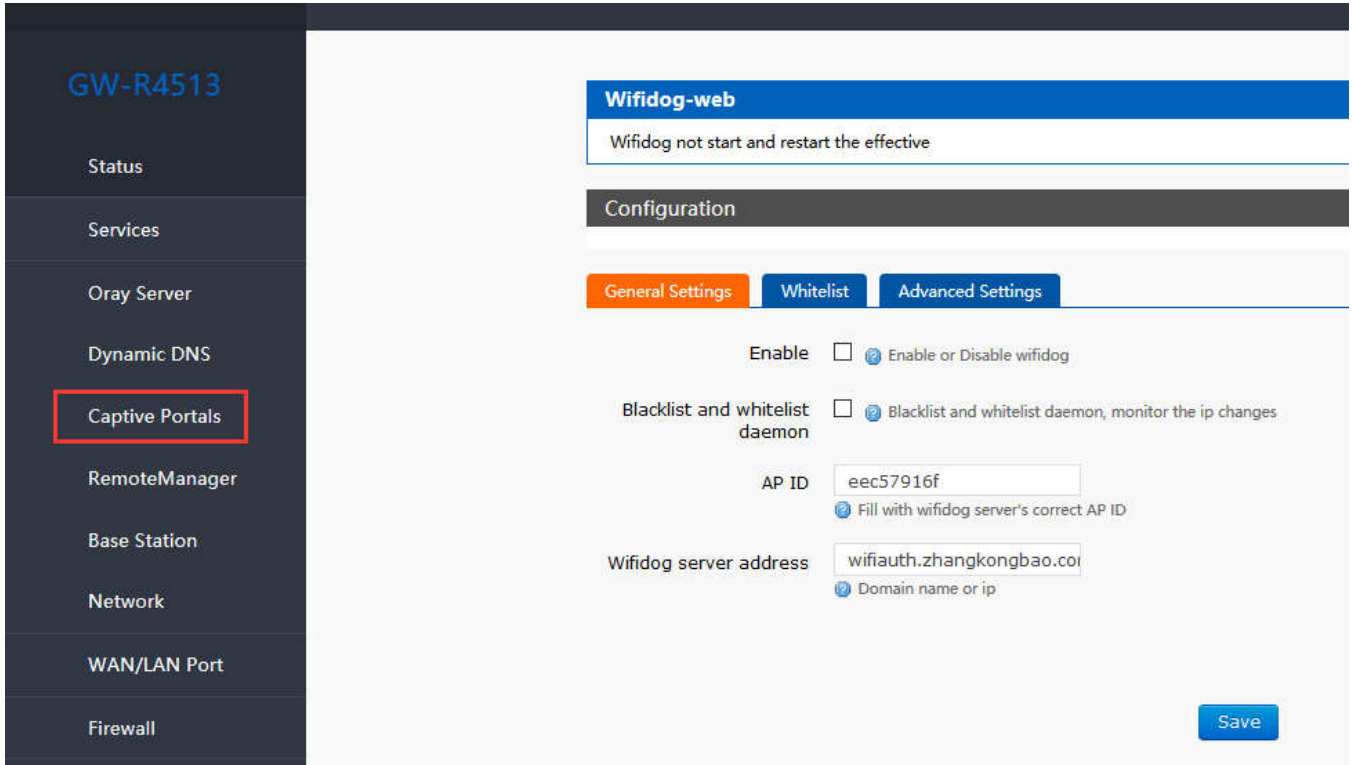
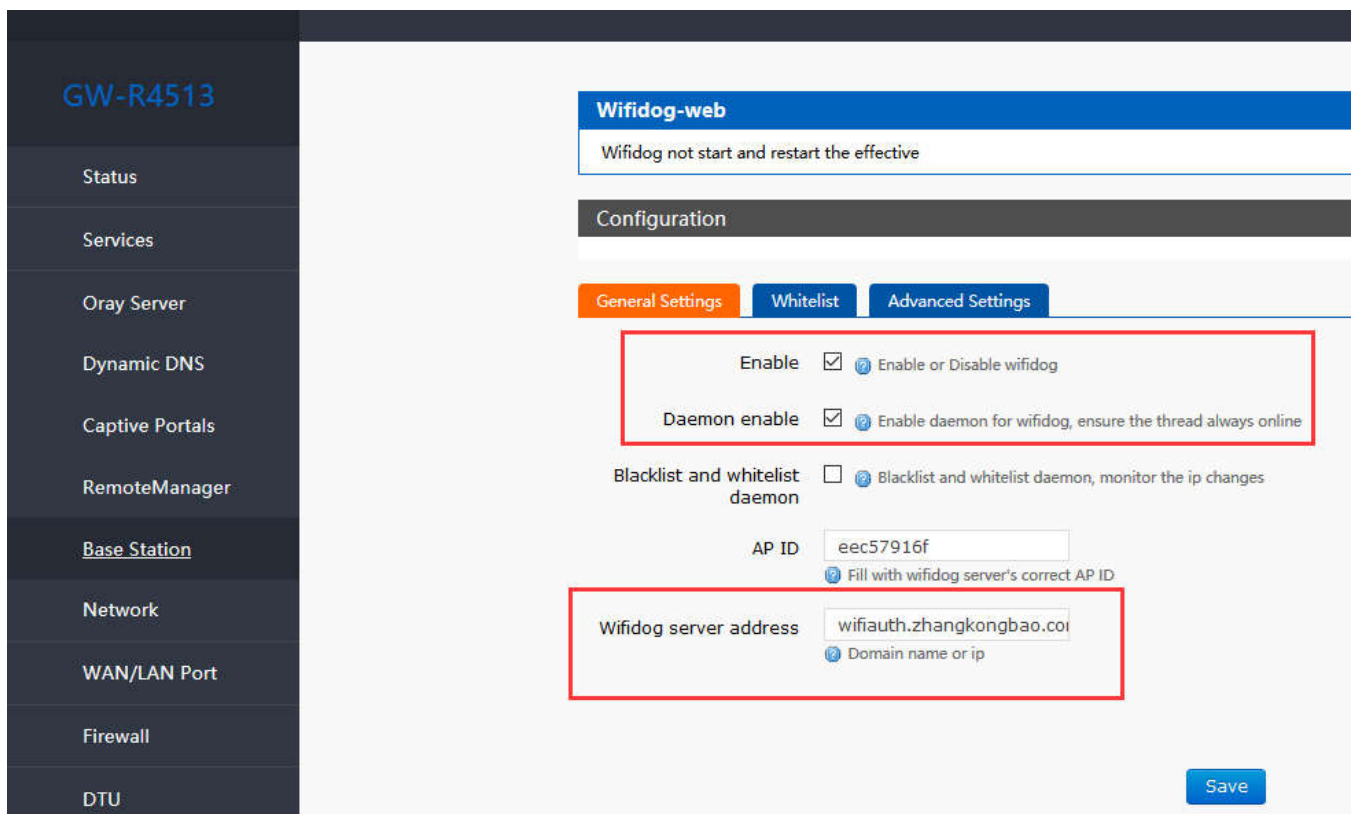

Figure16 the webpage1 of wifidog

Enable WI-FI dog



The screenshot displays the configuration page for Wifidog on the GW-R4513 device. The left sidebar contains a navigation menu with the following items: GW-R4513, Status, Services, Oray Server, Dynamic DNS, Captive Portals, RemoteManager, Base Station (highlighted), Network, WAN/LAN Port, Firewall, and DTU. The main content area is titled 'Wifidog-web' and shows a status message: 'Wifidog not start and restart the effective'. Below this is a 'Configuration' section with three tabs: 'General Settings' (selected), 'Whitelist', and 'Advanced Settings'. The 'General Settings' tab contains the following options:

- Enable**: Enable or Disable wifidog
- Daemon enable**: Enable daemon for wifidog, ensure the thread always online
- Blacklist and whitelist daemon**: Blacklist and whitelist daemon, monitor the ip changes
- AP ID**: Fill with wifidog server's correct AP ID
- Wifidog server address**: Domain name or ip

A blue 'Save' button is located at the bottom right of the configuration area.

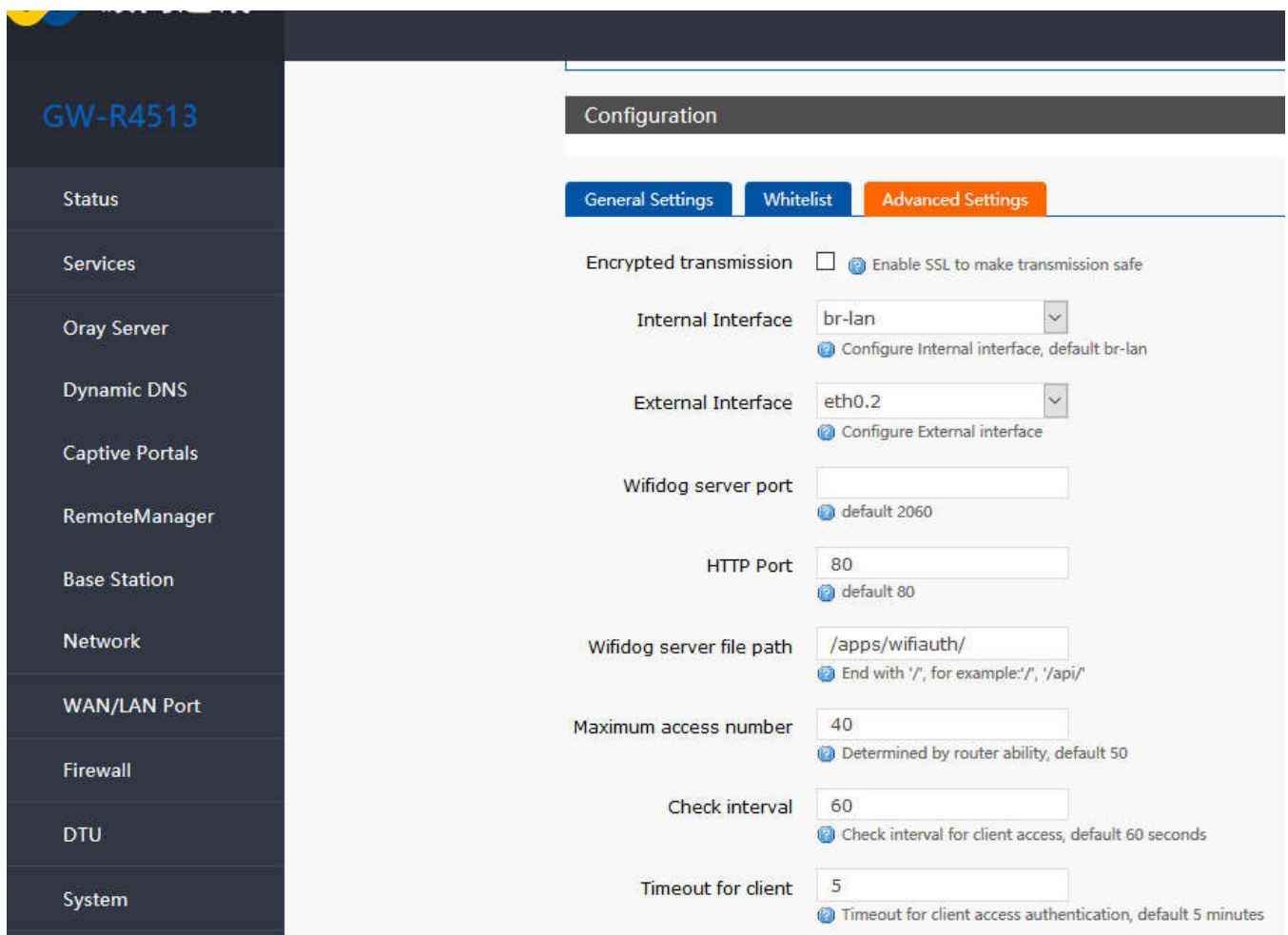

Figure17 the webpage2 of wifidog
Table5 WI-FI dog parameter

Function	Intro	Note
Enable WI-FI dog	Enable	If use
Daemon enable	Enable	If use
AP ID	nfuoId700	
Wifi dog server address	www.XXX.cn	
Internal interface	Br-lan	
External interface	Eth0.2	If use 4G, please fill in eth1
Wifi dog server file path	/apps/WIFIguanjia/	

3.4.3.LAN Interface

The LAN port is a local area network, there is 1 wired LAN port (WAN port can also be set to LAN port).

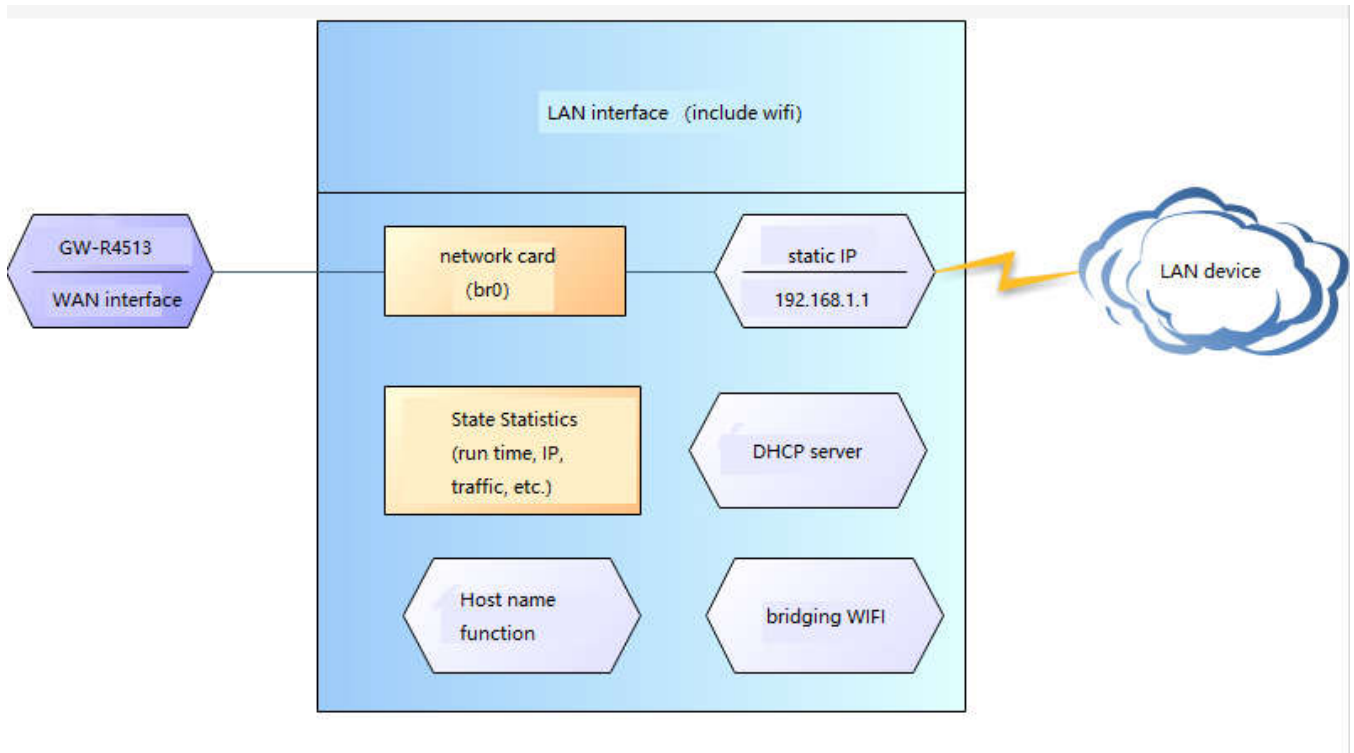

Figure18 LAN interface function

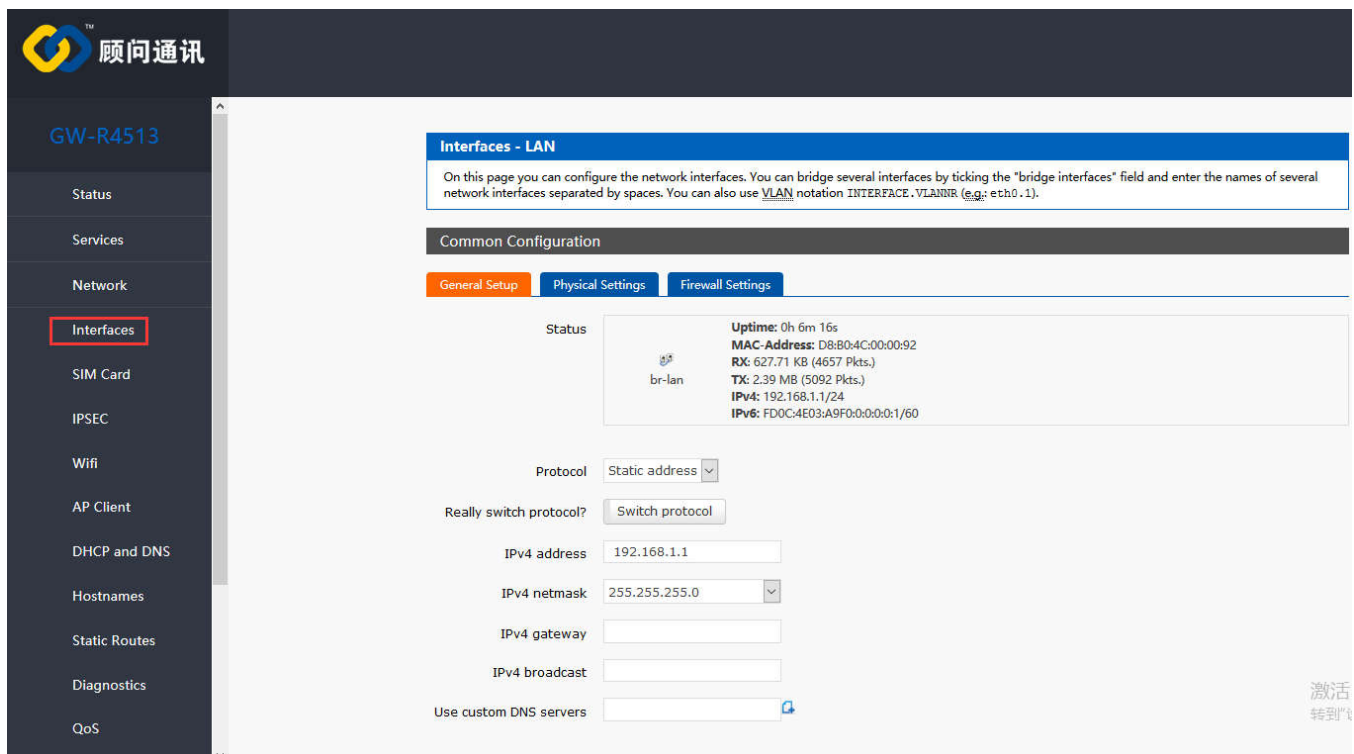

Figure 19 webpage of LAN interface setting

< Description >

- 1 LAN ports
- The default static IP address 192.168.1.1 and the subnet mask 255.255.255.0. This parameter can be modified,

such as static IP modification to 192.168.2.1.

- The WIFI interface (WLAN port) is bridged to the LAN port.
- By default, open the DHCP server function. All devices connected to the router's LAN port can automatically get the IP address.
- Simple state statistics function.

3.4.4.DHCP Function

The DHCP Server function of the LAN port is enabled by default (optionally turned off), and all network devices connected to the LAN port can automatically obtain IP addresses.

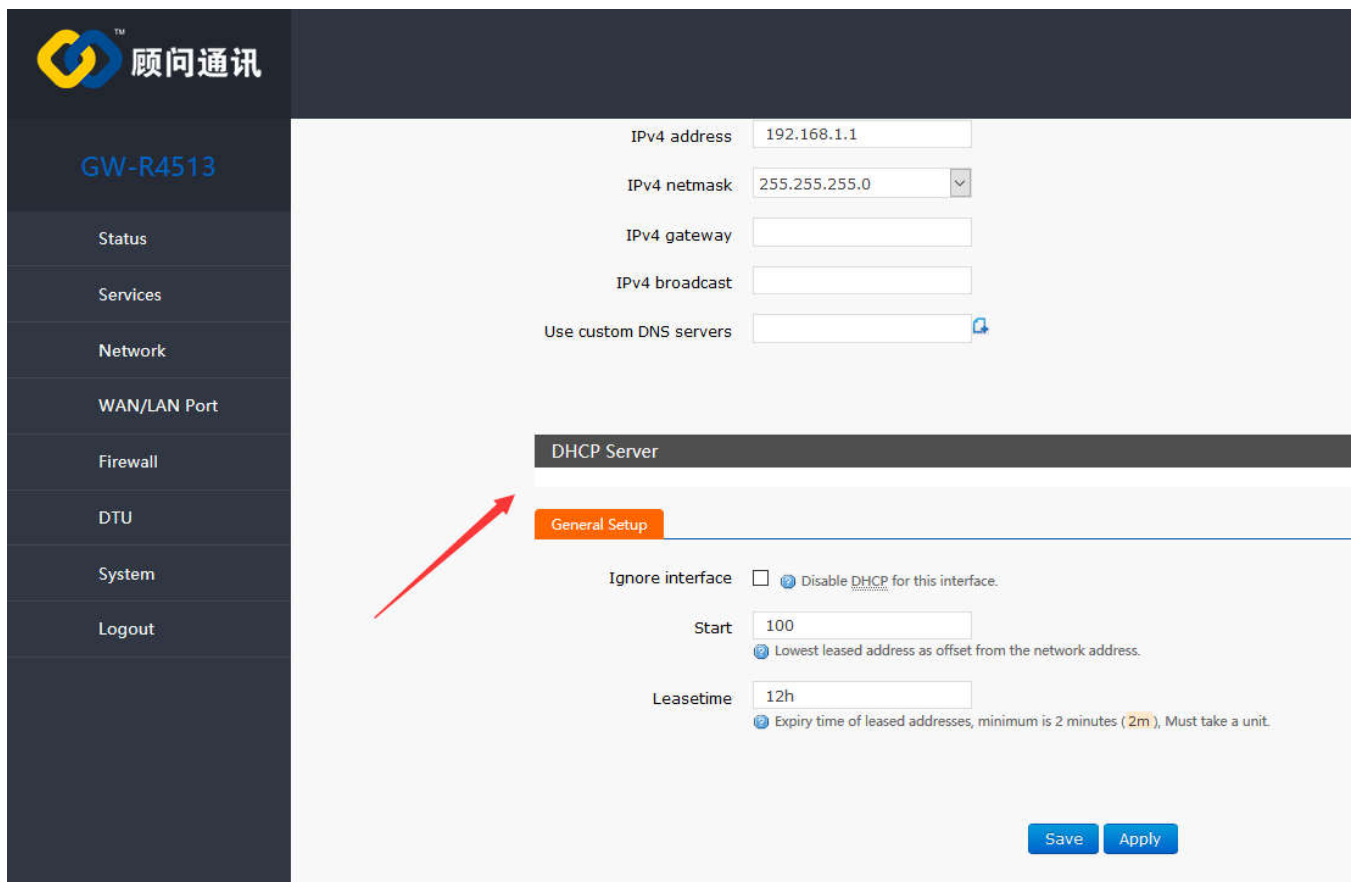

Figure20 webpage of DHCP setting

< Description >

- You can adjust the initial address of DHCP pool and address renting time.
- The default allocation range of DHCP starts from 192.168.1.100.
- Default rental time is 12 hours.

3.4.5.WAN Interface

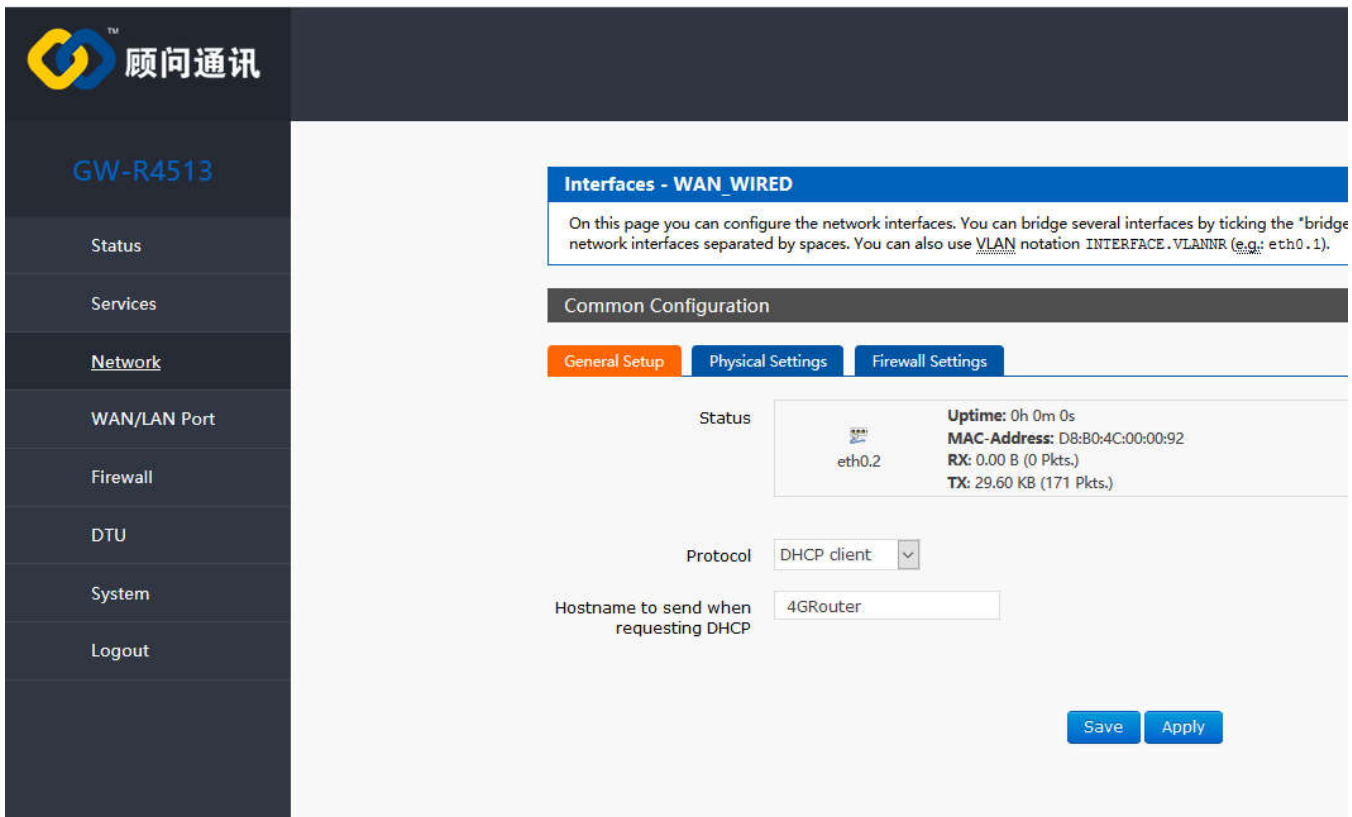

Figure21 webpage of WAN interface setting

WAN port is WAN interface.

< Description >

- 1 wired WAN ports
- Support DHCP client, static IP, PPPOE mode.
- Default DHCP client
- **Note:** The WAN interface can be set to LAN for the convenience of customers to communicate with multiple devices in the LAN. For specific settings, please refer to the Network Port Mode page.

3.4.6.Wi-Fi Wireless Interface

The functional diagram of WLAN is shown in the following figure:

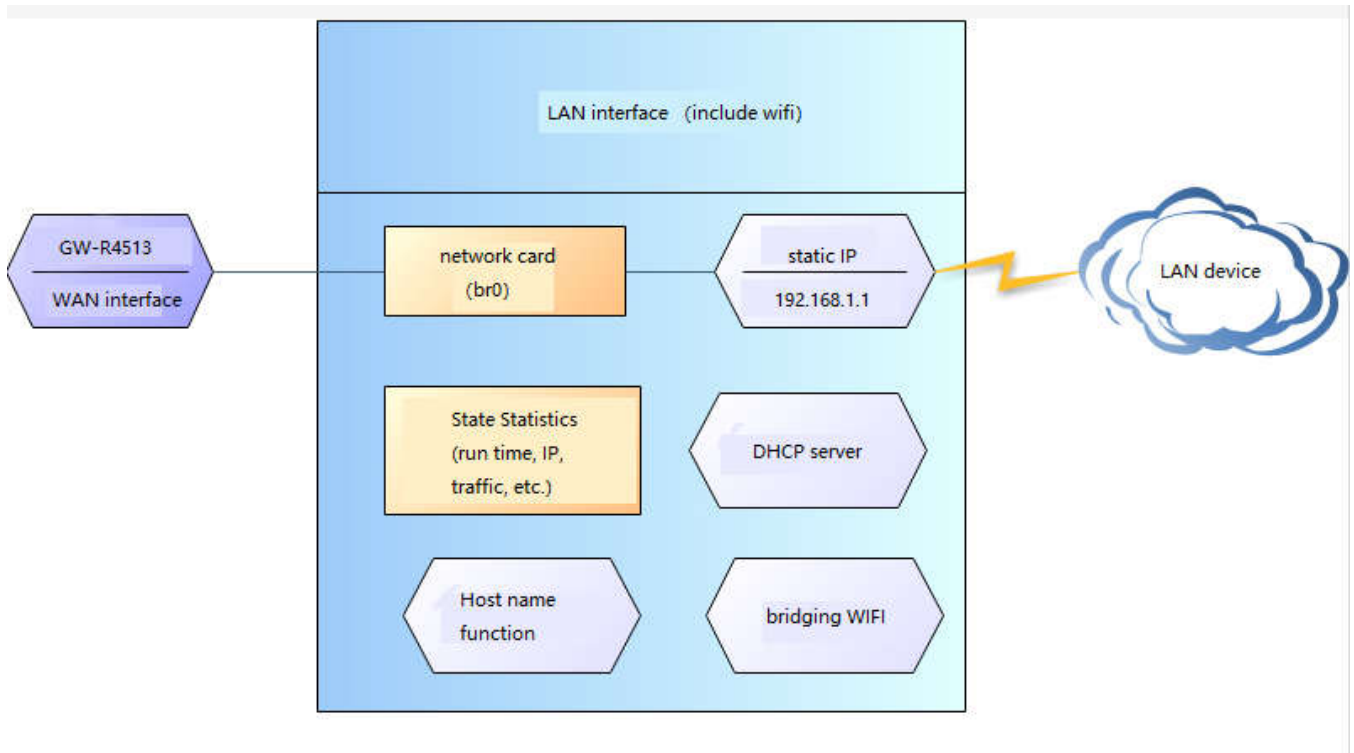

Figure22 WI-FI function

< Description >

- The GW-R4513 router is an AP, and other wireless terminals can access its WLAN network.
- Supports up to 24 wireless STA connections.
- WLAN, LAN and wired LAN port exchange each other.
- The maximum coverage of WIFI is 150m in the open area.

Table6 WIFI default parameter

Name	Parameter
SSID name	GW-R4513-XXXX (XXXX is the last 4 bit of MAC address)
Wi-Fi password	12345678
Channel	Auto
Bandwidth	40MHz
Encryption	WPA2-PSK

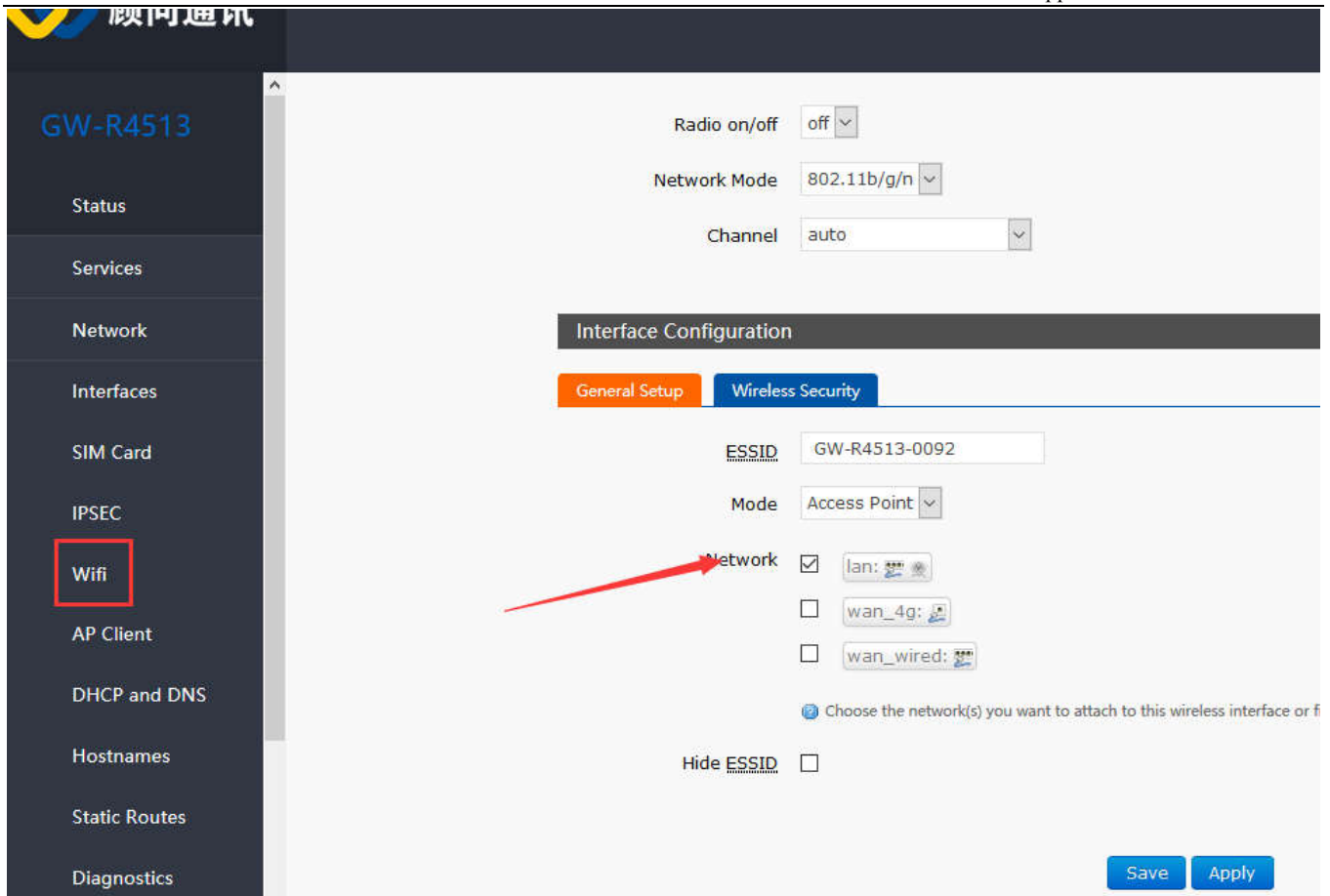

Figure23 the setting page of SSID

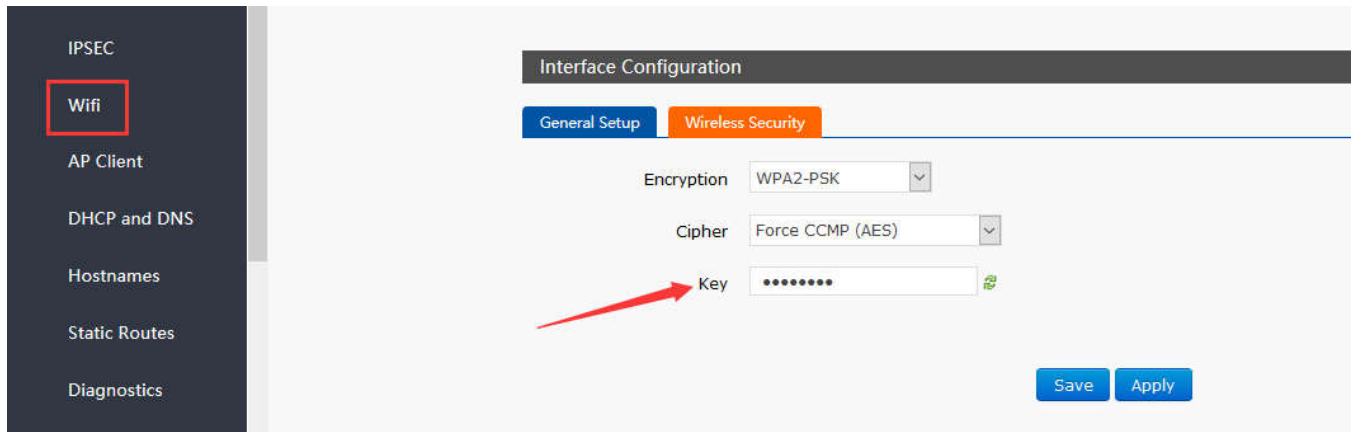

Figure24 the setting page of WI-FI

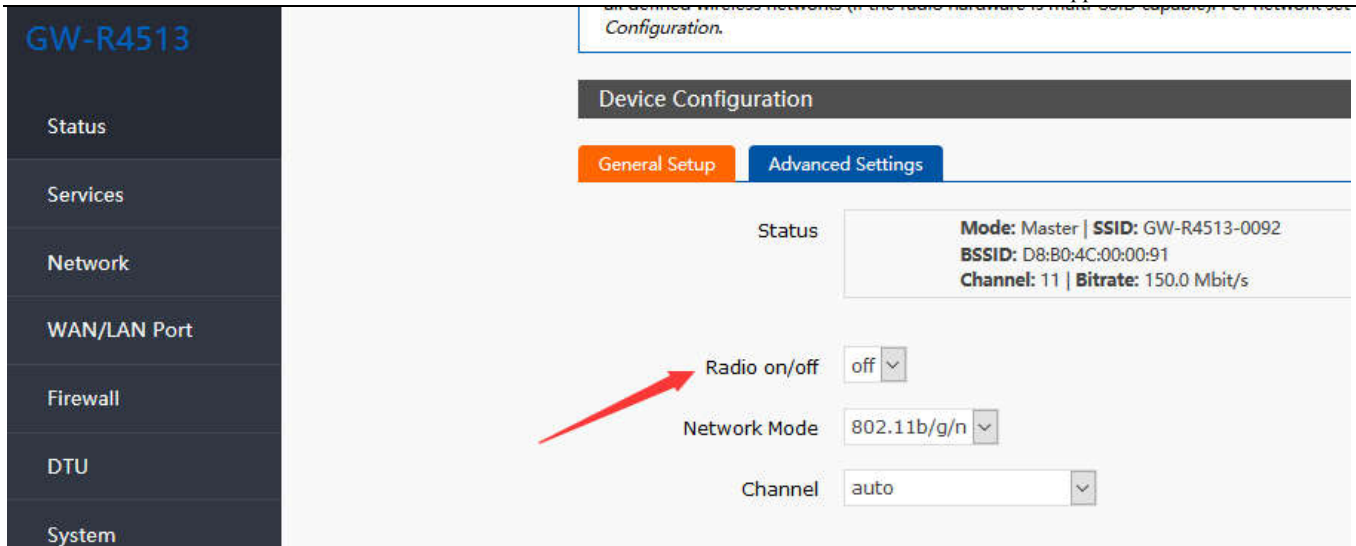

Figure25 the setting page of radio on/off

3.4.7.4G Interface

This router supports the interface of one 4G/3G/2G communication module to access external network.

4G interface function:

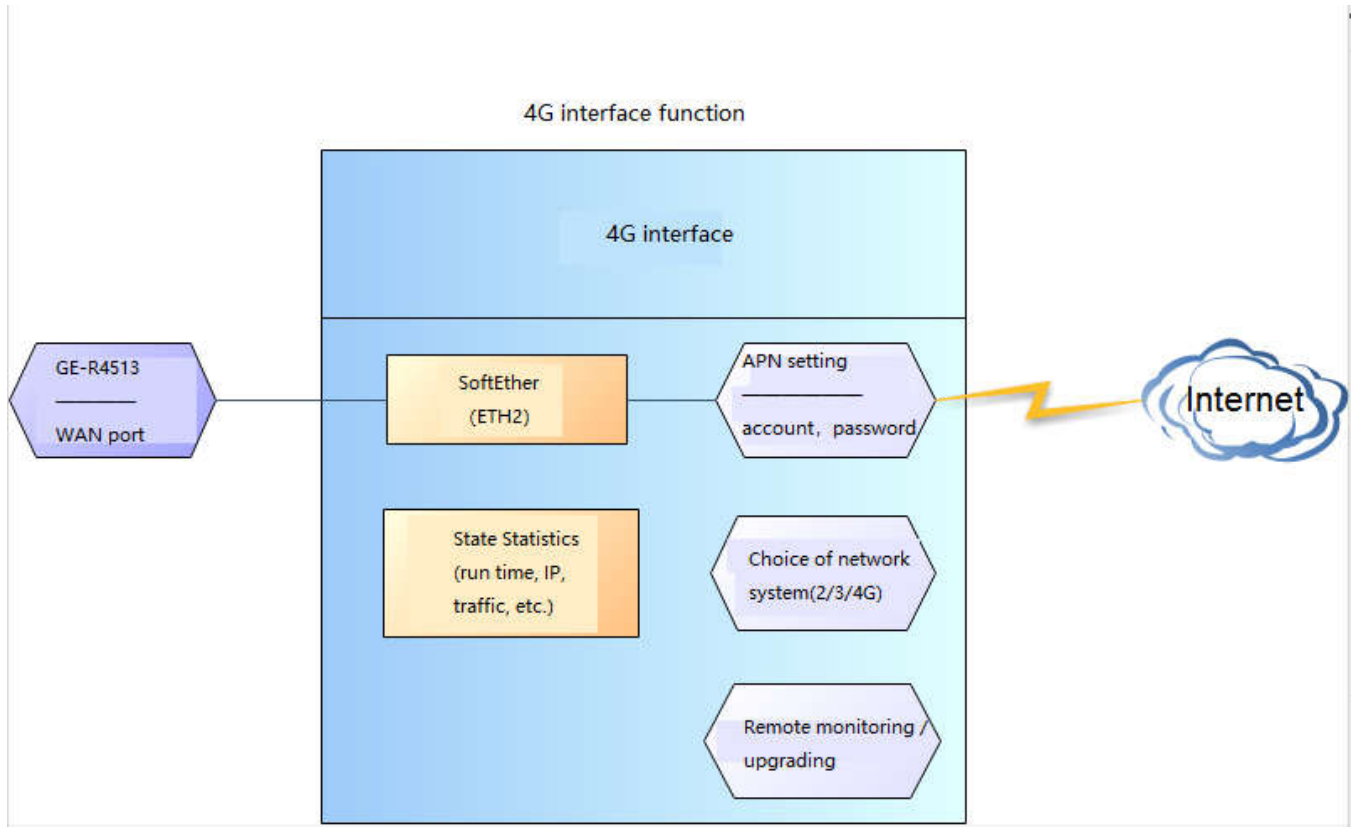

Figure 26 4G interface function

Webpage:

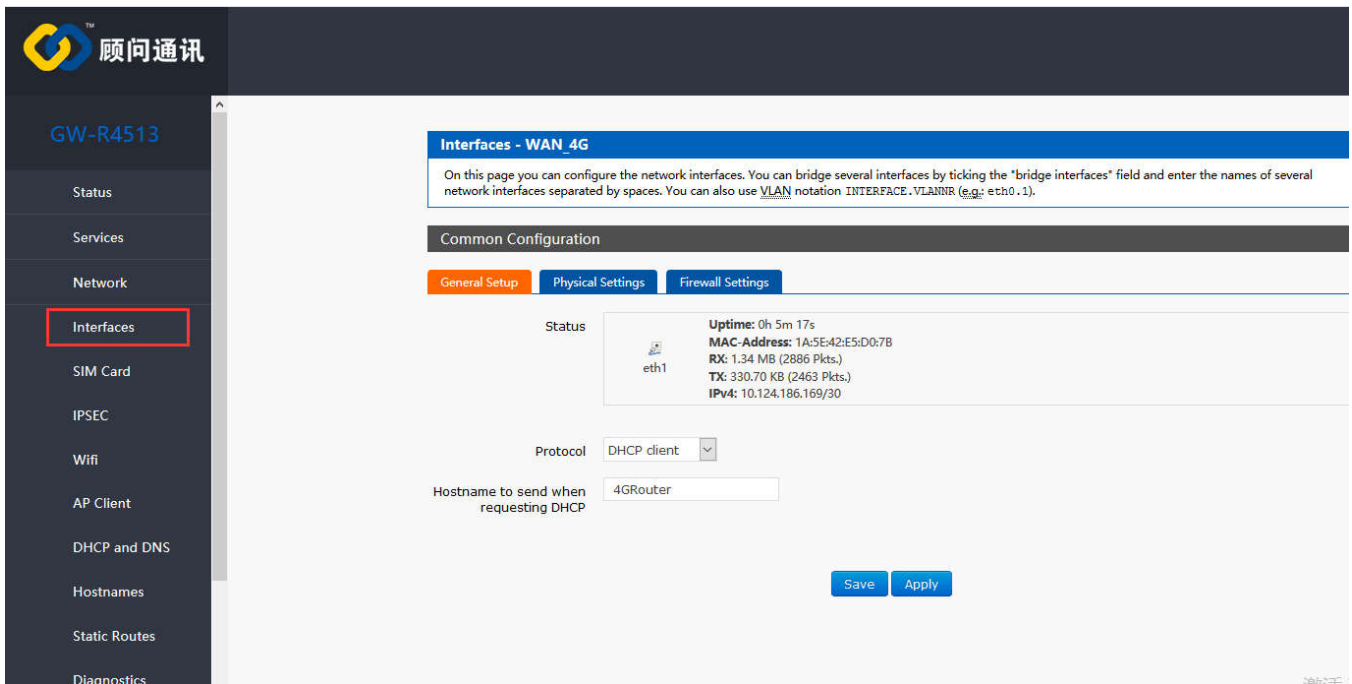

Figure 27 webpage

If the run time is 0, the network card can't run successfully.

Table7 status table

No	Name	Intro
1	Run time	The running time after power on
2	MAC address	The MAC address of interface
3	Receive/send	Statistics of receiving and sending data of this network card
4	IPv4	The IPv4 protocol of this network card

< Description >

- GW-R4513-AU(operating band): FDD-LTE(1/2/3/4/5/7/8/28),TDD-LTE(40),WCDMA(1/2/5/8),GPRS(2/3/5/8)
- GW-R4513-E(operating band): FDD-LTE(1/3/5/7/8/20),TDD-LTE(38/40/41),WCDMA(1/5/8),GPRS(3/8)
- The protocol of 4G interface: do not modify, keep the default.
- The router will give priority to the use of wired WAN ports, followed by the use of 4G networks.
- If you use APN private network, please refer to the introduction of APN chapter.

3.4.8.APN Setting

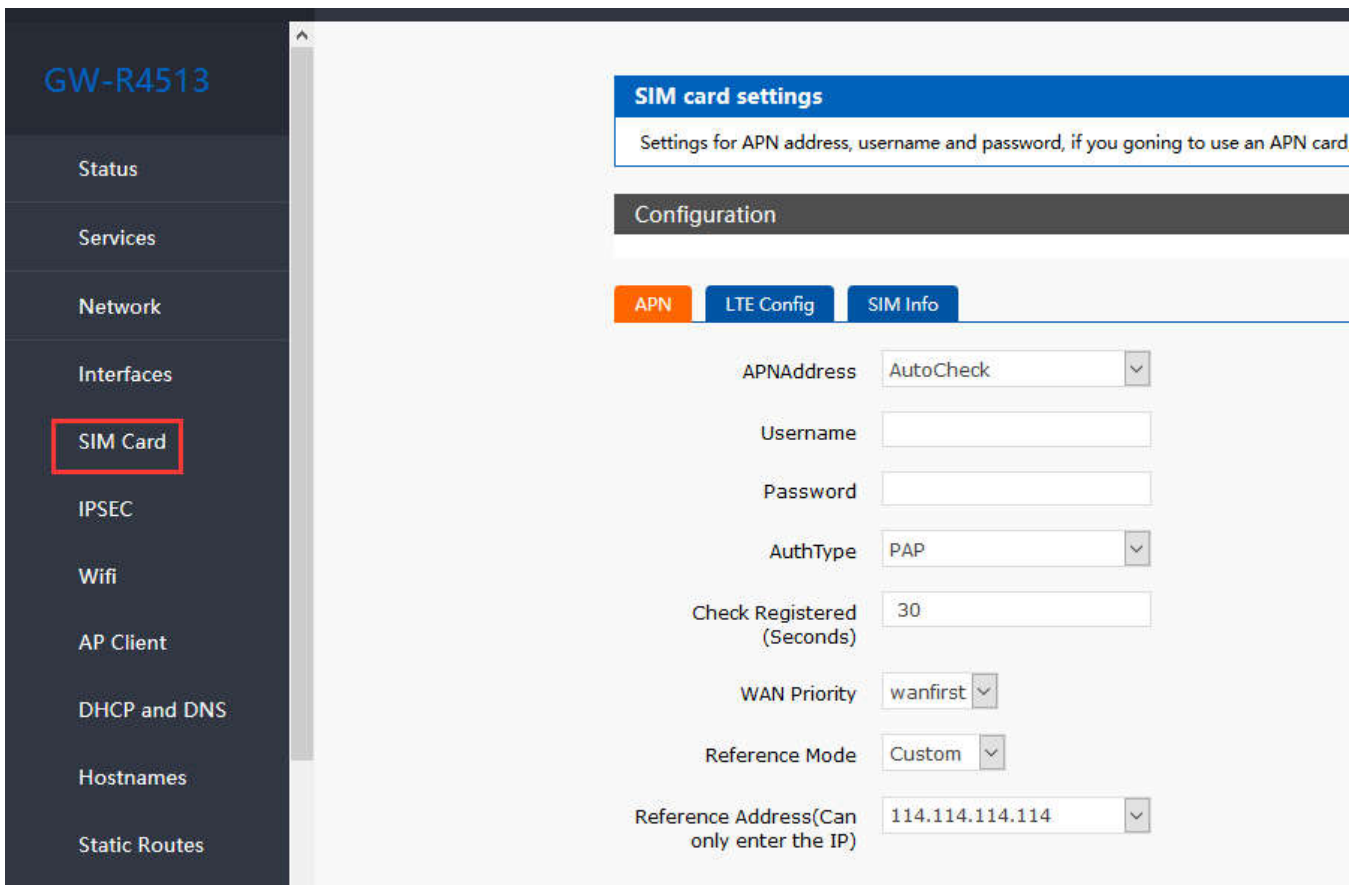

Figure28 the webpage2 of APN setting

If you use an APN card and have a special APN address, you need to set the APN address, username, and password.

Table8 APN parameter

Parameter name	Function
APN address	Fill in the APN address
Use name	The default is empty. If you use APN card, please fill in correctly.
Password	The default is empty. If you use APN card, please fill in correctly.
Type of PDP	Default
Auth type	Default
Others	Please keep default

Note

- Normal 4G mobile phone card, without setting up, you can access the Internet.
- If you use APN special network card, you must fill in the APN address, user name and password.

3.4.9.VPN Client(PPTP/LTTP/GRE/OPENVPN)

3.4.9.1. PPTP Client

We first create VPN Server on the server.

Open the network connection page on the server (remote server) and click File - > New incoming connection.

Then, select Add account, please enter user name, password and other information..

Click Next and check through Internet to connect to this computer.

Then, select "Internet Protocol Version 4" to set the properties of the incoming IP, IP address assignment select "Specify IP Address", then select "OK" and "Allow Access".

Now we create a VPN server.

Let's talk about the use of VPN Client. We are looking for a computer in the LAN to ensure that it can access the server above. Then create a new VPN connection.

In the connection box, click "Properties", the tab can set the target address (the address of the VPN server), security options to select "PPTP protocol", after the point is determined, enter the username, password.

Click the "Connect" button, after the connection is successful, you can see the VPN network card connection, from grey to bright color, representing the VPN connection has been successfully established.

Next we use the PPTP Client on the router to replace the way of computer dialing.

Assuming that the user has obtained the VPN server address, account and password, we create an interface, select the PPTP protocol, and write the other parameters in turn.

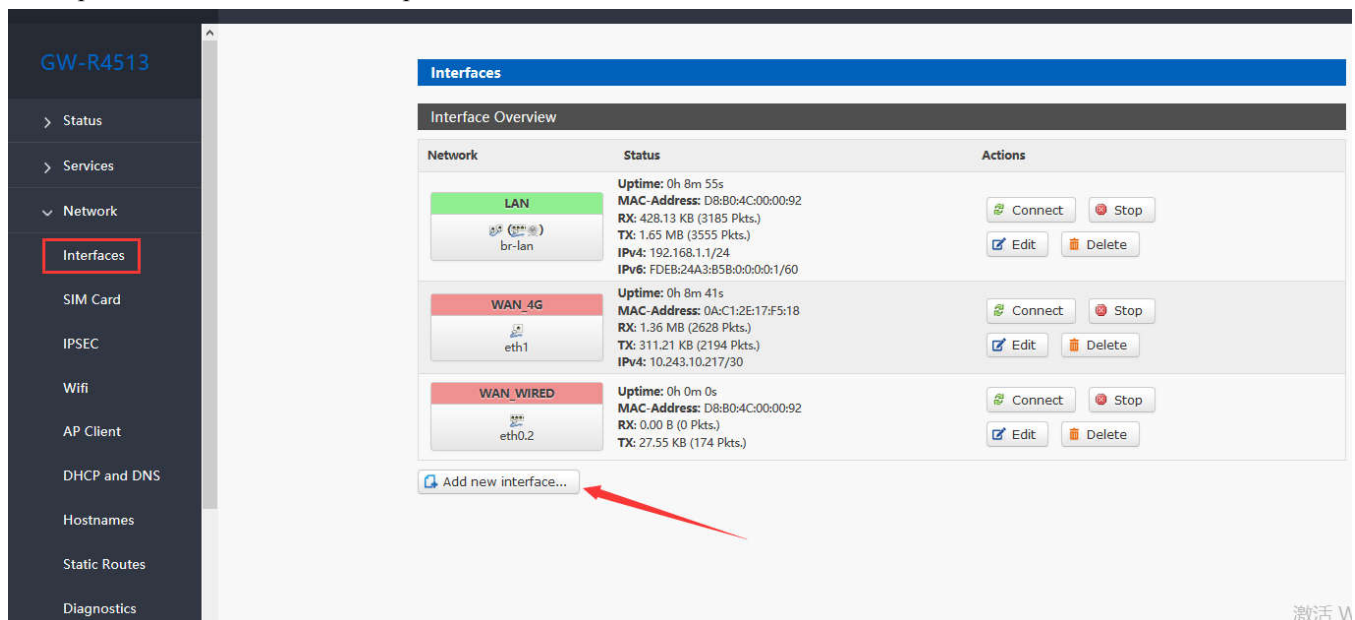

Figure29 the webpage1 of VPN

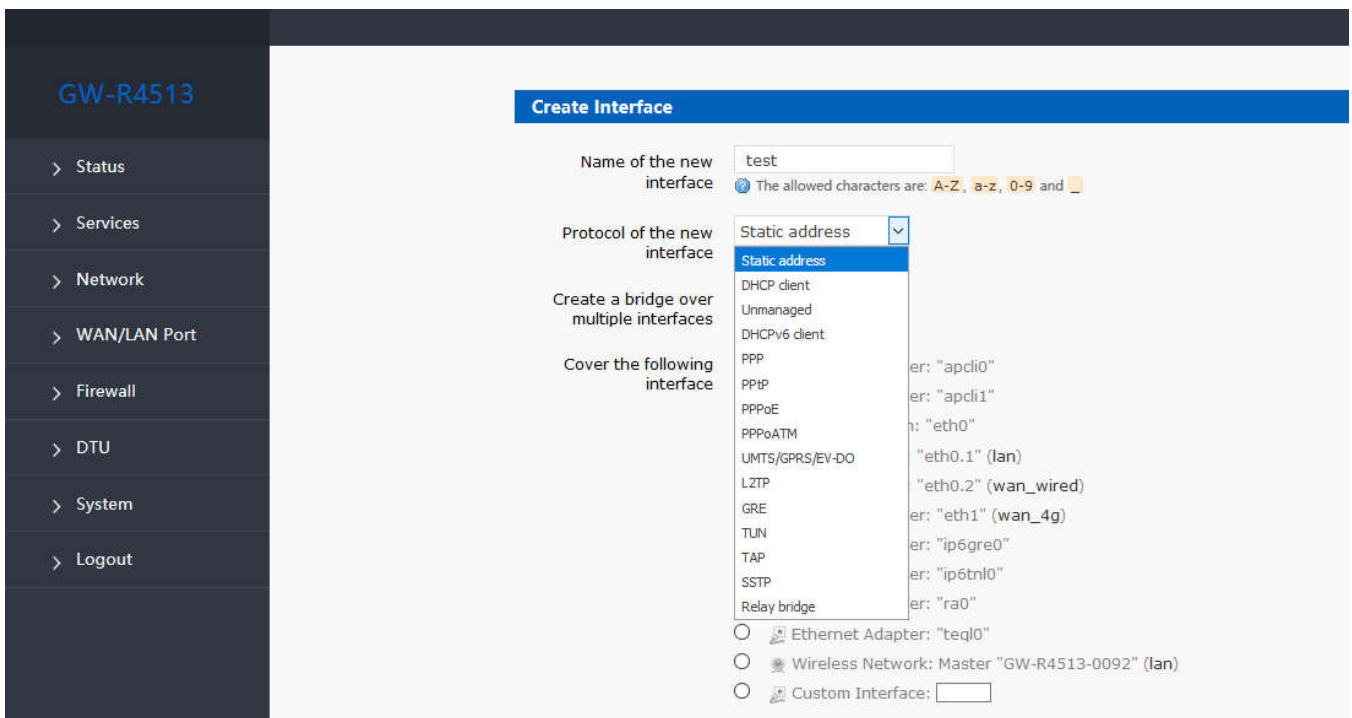

Figure30 the webpage2 of VPN

Select WAN, because it is dialing at WAN port, then save and apply.

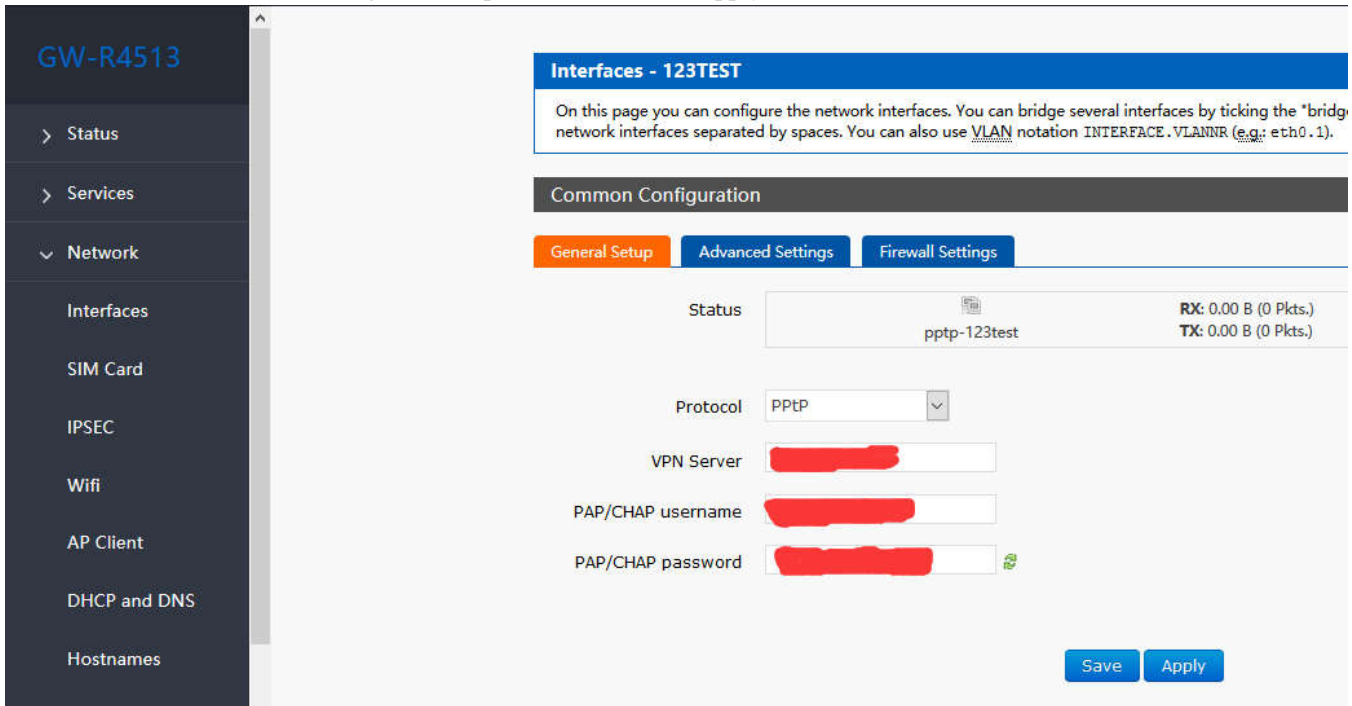

Figure31 the webpage3 of VPN

Wait a minute or restart the router, when you see the "VPN" interface in the router page, there is a run time (not 0), indicating that the current VPN has been successfully started.

Note:

- Currently PPTP supports MPPE encryption and a variety of authentication methods. Specific settings can be viewed in advanced settings for authentication.

- Only MSChapV2 indicates that MPPE encryption is only supported.
- MSChapV2 EAP PAP CHAP supports MPPE encryption and multiple authentications.
- Other means do not handle, default status, only CHAP authentication by default.

3.4.9.2. L2TP Client

1. L2TP supports multiple authentication (MSCHAPV2, CHAP, EAP, PAP), MPPE encryption, L2TP OVER IPSEC encryption.
2. increased the way of tunnel password authentication.

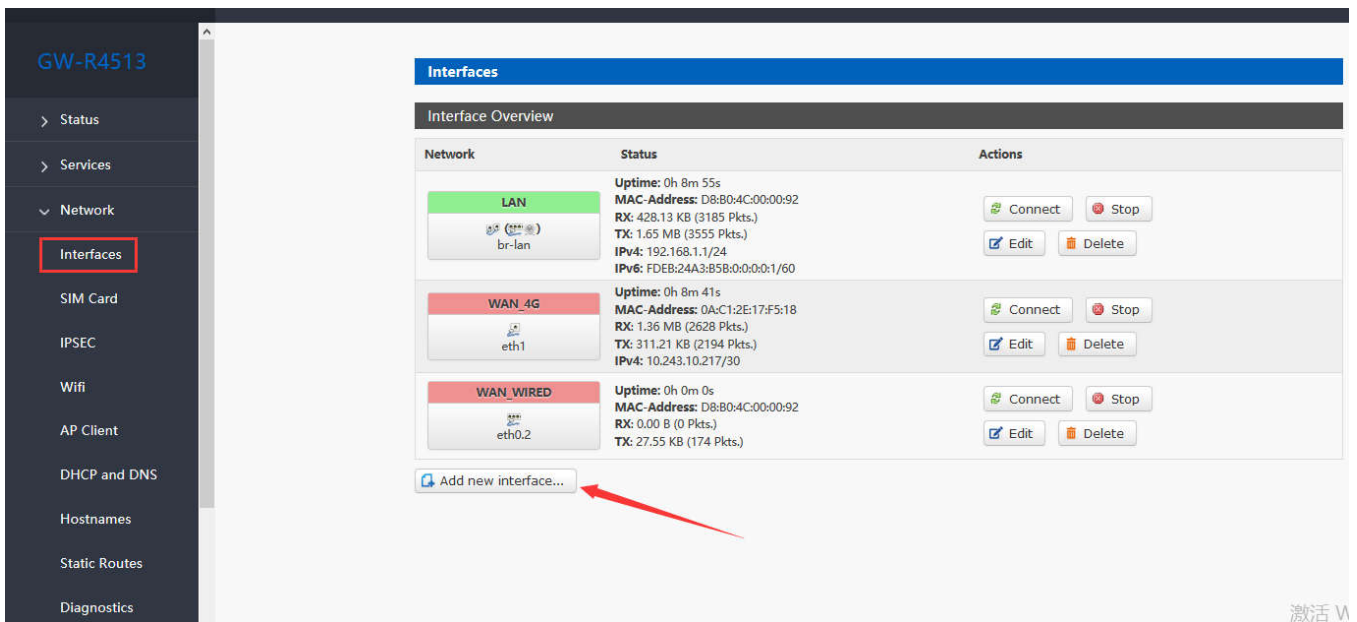

Figure32 create interface

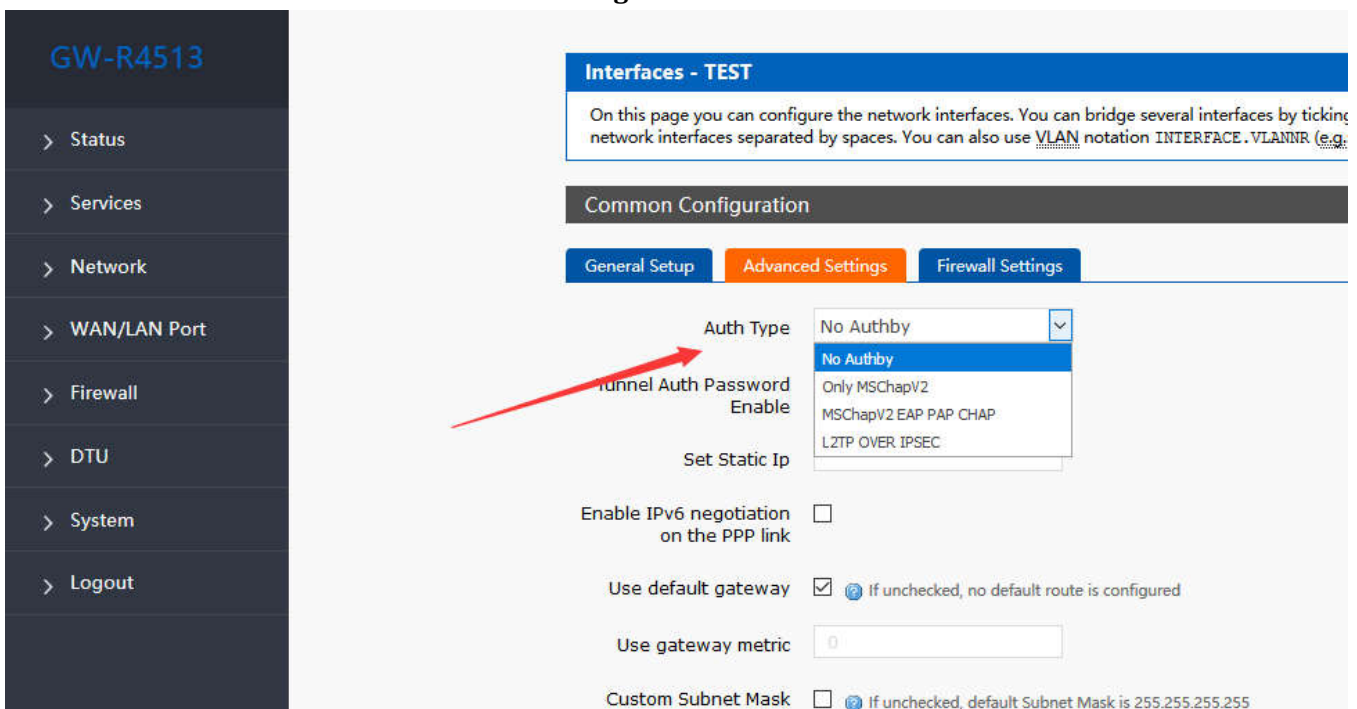

Figure33 auth type

GW-R4513

- > Status
- > Services
- > Network
- > WAN/LAN Port
- > Firewall
- > DTU
- > System
- > Logout

Interfaces - TEST

On this page you can configure the network interfaces. You can bridge several interfaces by ticki network interfaces separated by spaces. You can also use VLAN notation INTERFACE.VLANNR (e.g.

Common Configuration

General Setup | **Advanced Settings** | Firewall Settings

Auth Type: No Authby

Tunnel Auth Password Enable

Tunnel Auth Password: 123456
character: 1-16

Set Static Ip:

Enable IPv6 negotiation on the PPP link

Use default gateway If unchecked, no default route is configured

Use gateway metric:

Custom Subnet Mask Enabled If unchecked, default Subnet Mask is 255.255.255.255

Figure34 tunnel auth password

GW-R4513

- > Status
- > Services
- > Network
- > WAN/LAN Port
- Firewall
- > DTU
- > System
- > Logout

Interfaces - TEST

On this page you can configure the network interfaces. You can bridge several ir network interfaces separated by spaces. You can also use VLAN notation INTERI

Common Configuration

General Setup | **Advanced Settings** | Firewall Settings

Auth Type: L2TP OVER IPSEC

IPSEC CONNECT NAME:

IKE Algorithm: 3DES-SHA1

SA Type: ESP

ESP Algorithm: 3DES-SHA1

PSK:

Tunnel Auth Password Enable

Tunnel Auth Password: 123456
character: 1-16

Figure35 L2TP OVER IPSEC auth type

3.4.9.3. IPSEC

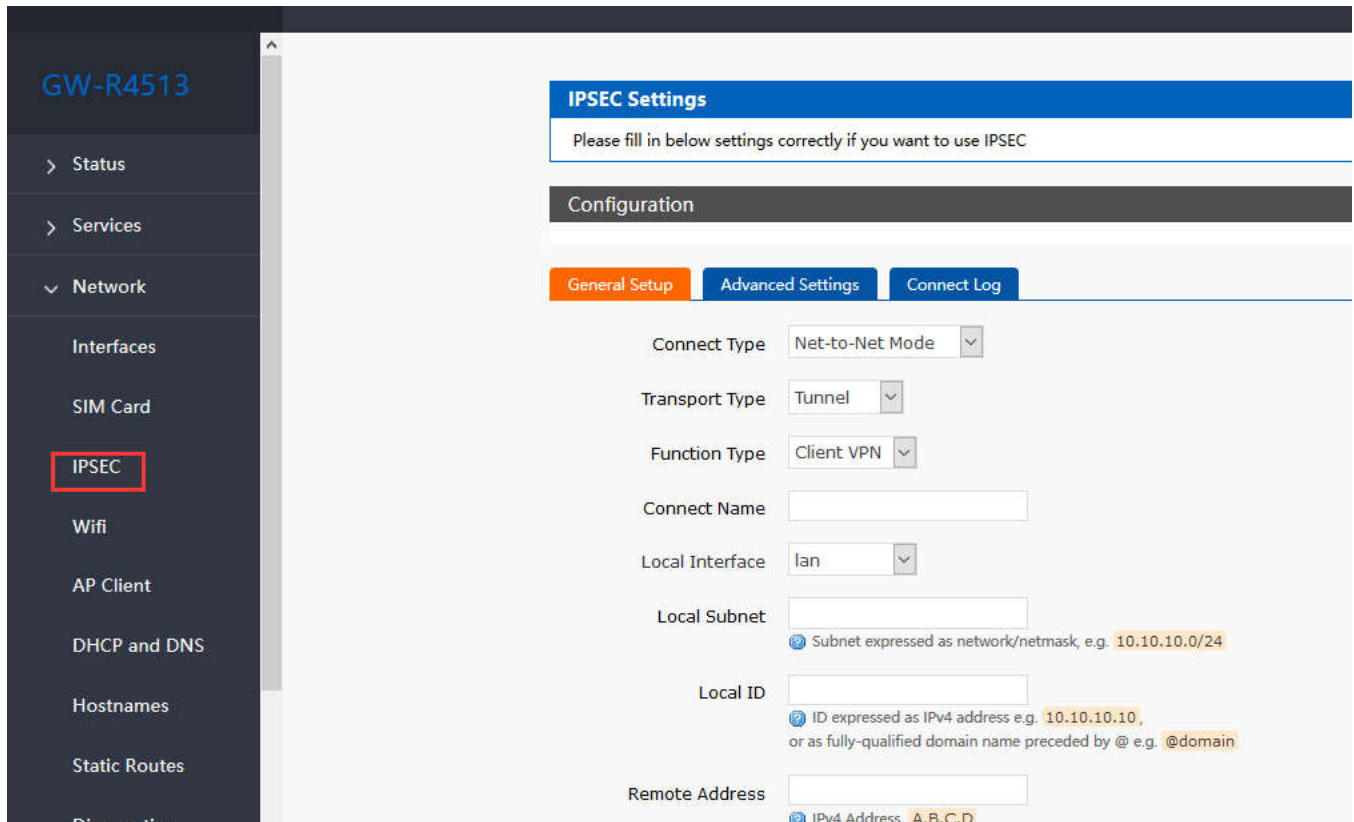

IPSEC Settings

Please fill in below settings correctly if you want to use IPSEC

Configuration

General Setup | **Advanced Settings** | Connect Log

Connect Type: Net-to-Net Mode

Transport Type: Tunnel

Function Type: Client VPN

Connect Name:

Local Interface: lan

Local Subnet:
Subnet expressed as network/netmask, e.g. 10.10.10.0/24

Local ID:
ID expressed as IPv4 address e.g. 10.10.10.10, or as fully-qualified domain name preceded by @ e.g. @domain

Remote Address:
IPv4 Address. A.B.C.D

Figure36 IPSEC setting

Selection of application modes: Net-to-Net mode (site-to-site or gateway-to-gateway), Road Warrior mode (end-to-site or PC-to-gateway)

- Transmission mode selection: tunnel mode and transmission mode. It can be selected in the transport type.
- Functional types: VPN client and VPN server.
- Connection name: indicate the name of the connection, must be unique.
- Local interface: wan_wried, wan_4g.
- Remote address: IP/ domain name.
- Local Subnet: IPSEC Local Protected Subnet and Subnet Mask. If you choose the Road Warrior client, you do not need to fill in.
- For terminal network: IPSEC end protection subnet and subnet mask.
- Local terminal identifier: the channel local identifier can be IP or domain name. Note that when the domain name is customized, add @
- End terminal identifier: the channel end identifier, it can be IP or domain name. Note that when domain name is customized, add @

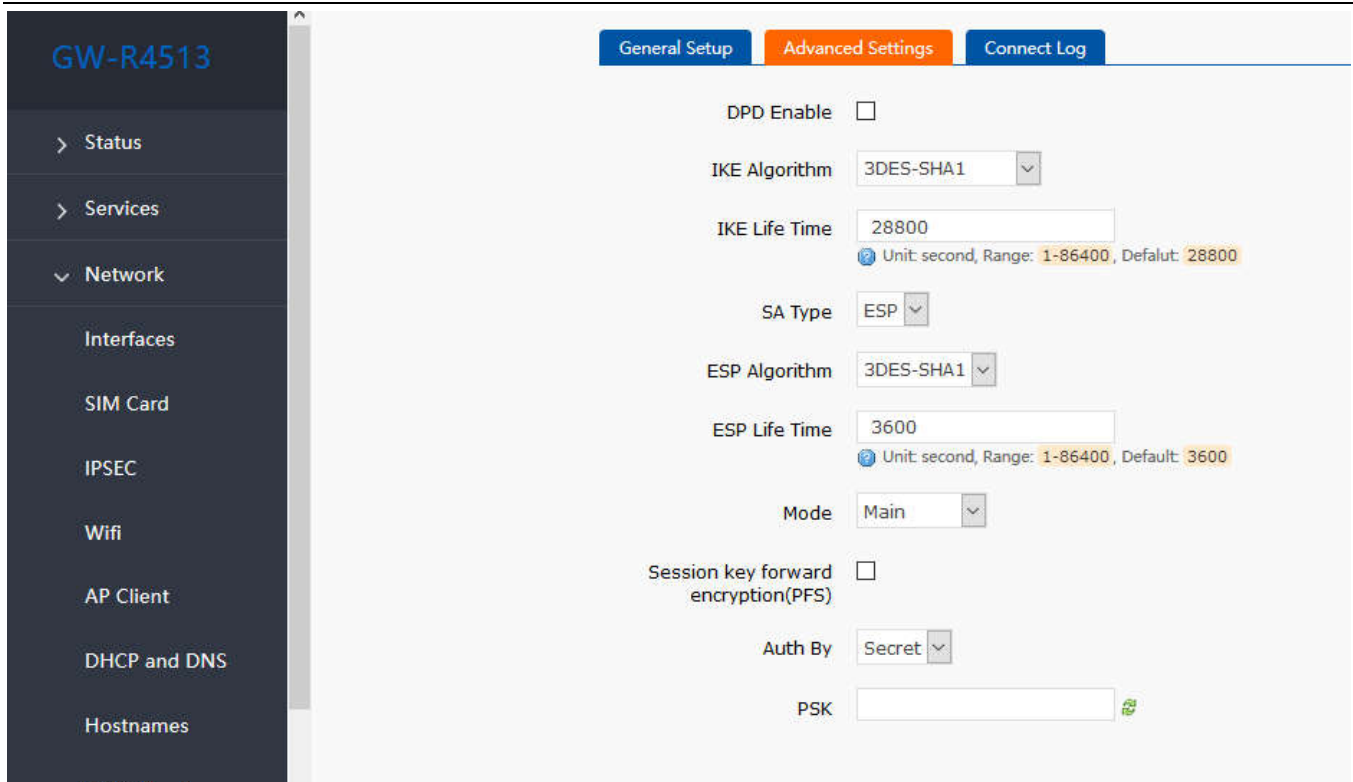

Figure37 IPSEC advance setting

Start DPD detection: whether to enable this function, hook is indicated to enable.

DPD interval: set the time interval of connection detection (DPD).

DPD timeout time: set up the timeout time of connection detection (DPD).

DPD operation: sets the operation of connection detection.

IKE encryption: the first phase includes encryption, integrity and DH switching in the IKE stage.

IKE life cycle: set the life cycle of IKE, in seconds, default: 28800.

SA type: ESP and AH can be selected in the second stage.

ESP encryption: select the corresponding encryption mode and integrity scheme.

ESP life cycle: set ESP life cycle, unit: s, default: 3600

Mode: negotiation mode default main mode, aggrmode can be selected.

Session secret key forward encryption (PFS): if hook is activated, PFS will enable.

Authentication method: currently supports the pre shared key authentication method.

Note

After the configuration, the ISAKMP SA established flag in the connection log indicates that the IPSEC VPN was created successfully.

3.4.9.4. OPENVPN

Add one interface, choose TUN or TAP mode:

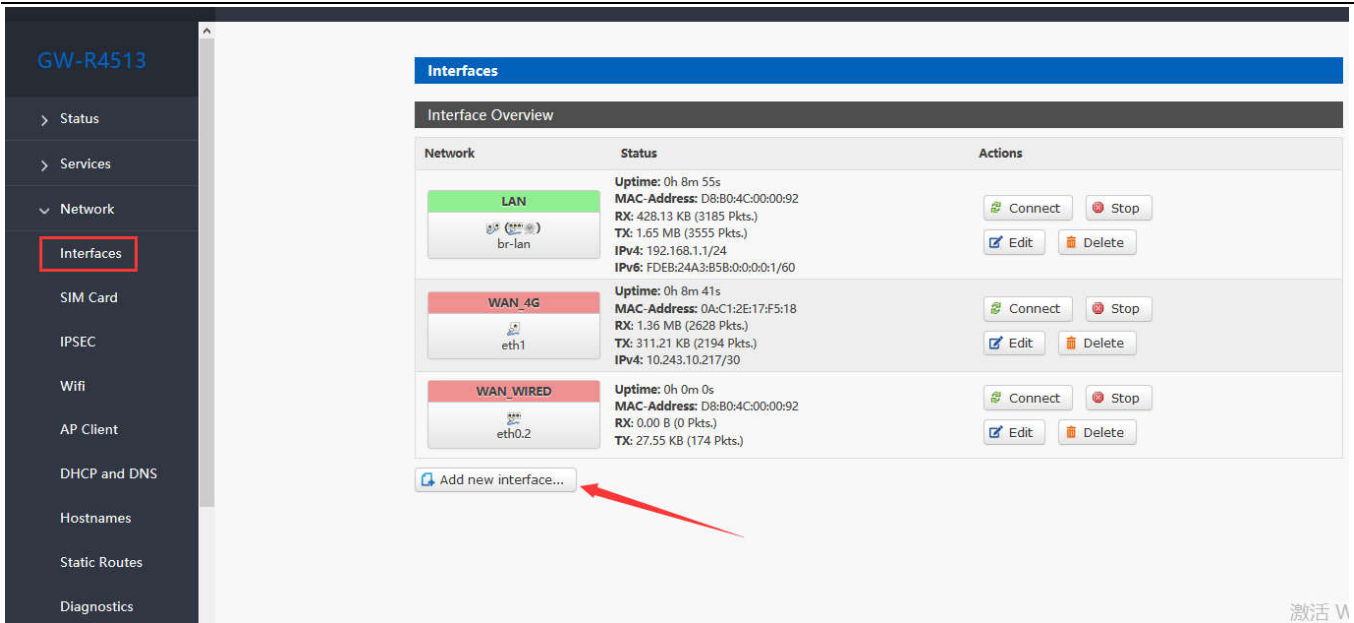

Figure38 add new interface

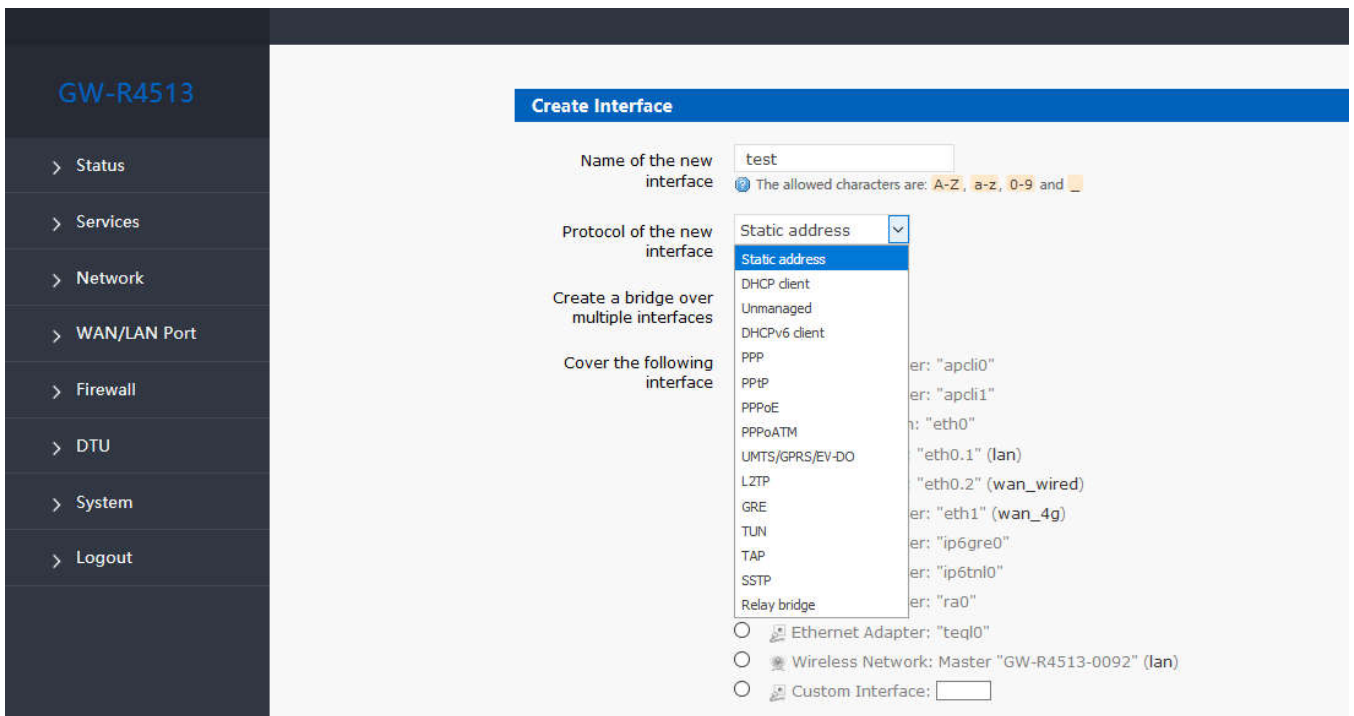

Figure39 add OPENVPN interface

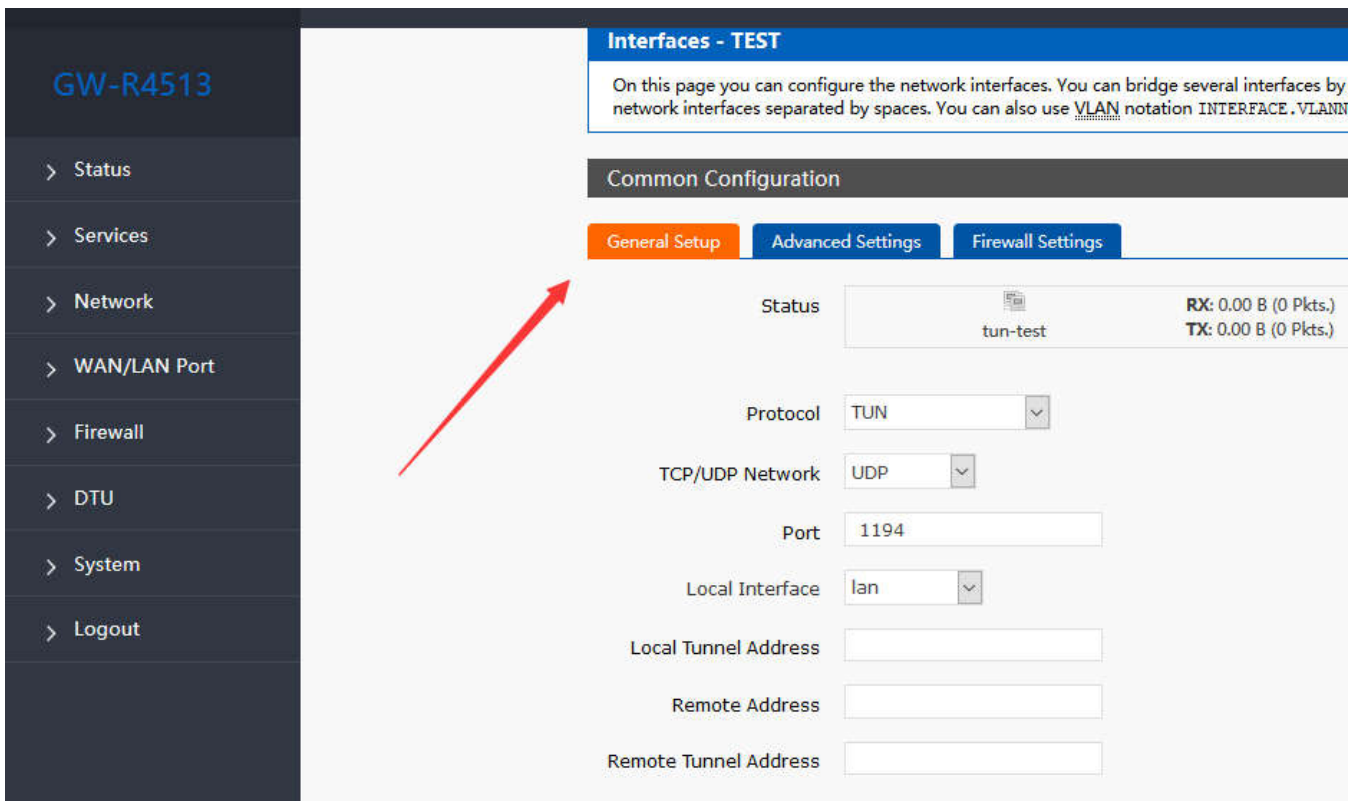

Figure40 general setting

Protocol: TUN (routing mode) or TAP (bridge mode).

Channel protocol: UDP or TCP

Port: the listening port of the OPENVPN client.

Interface of this terminal: it can be wan_wired and wan_4g.

Remote address: the IP/ domain name of the server.

Local tunnel address: set the local tunnel address, such as 192.168.10.1, otherwise the default server automatically allocates.

Remote Tunnel Address: set the tunnel address on the opposite side, such as 192.168.10.1, otherwise the default server automatically allocates.

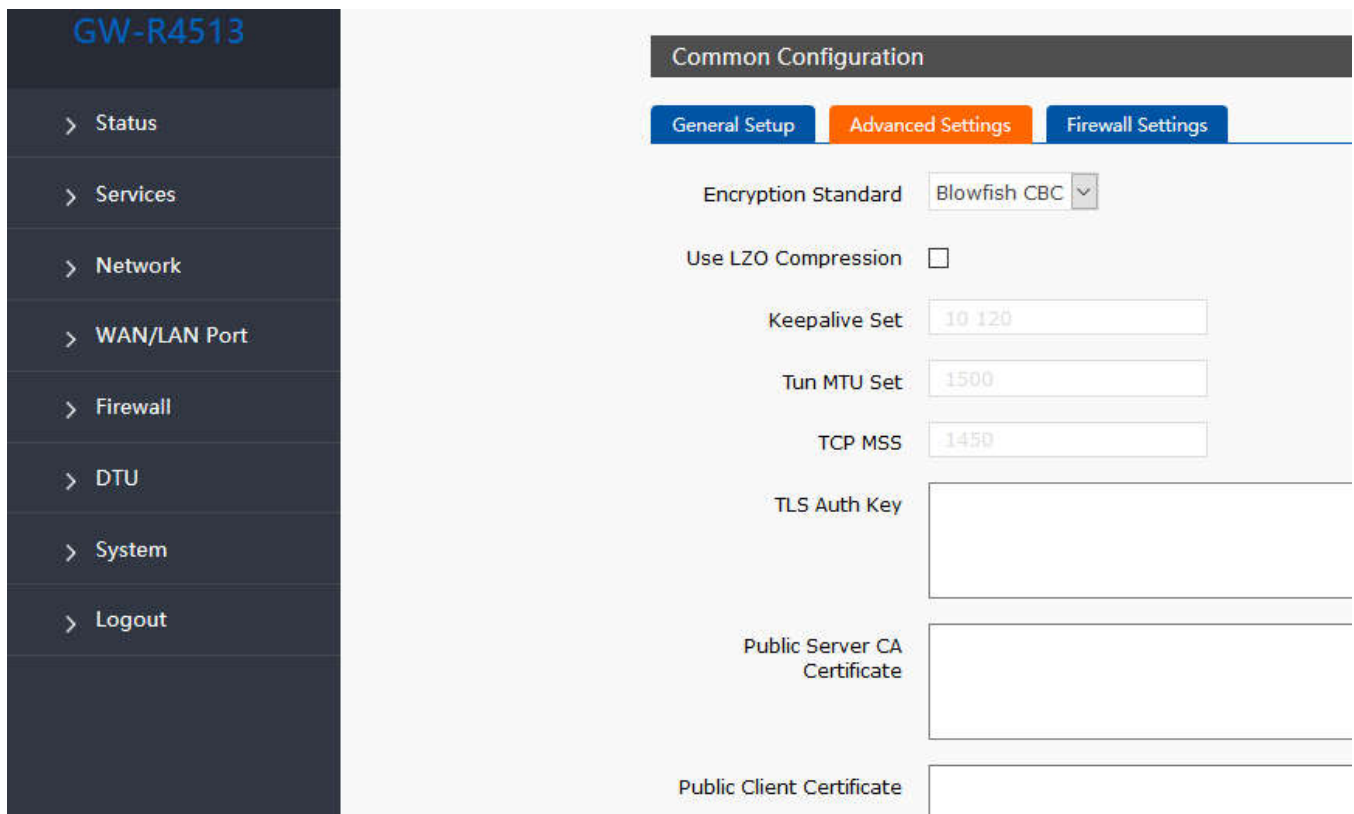

The screenshot shows the 'Common Configuration' section of the GW-R4513 web interface. The 'Advanced Settings' tab is selected. The configuration options are as follows:

- Encryption Standard:** Blowfish CBC (selected from a dropdown menu)
- Use LZO Compression:**
- Keepalive Set:** 10 120
- Tun MTU Set:** 1500
- TCP MSS:** 1450
- TLS Auth Key:** (empty text input field)
- Public Server CA Certificate:** (empty text input field)
- Public Client Certificate:** (empty text input field)

Figure41 advance setting

Encryption Standard: Blowfish CBC, AES-128 CBC, AES-192 CBC, AES-256 CBC, AES-512 CBC

LZO compression: enable or disable transmission data using LZO compression.

Keep-alive settings: default is 10120.

TUN MTU settings: set the MTU value of the channel.

TCP MSS : maximum segment size of TCP data

TLS authentication key: authentication key of secure transport layer

Public service CA certificate: CA certificate of server and client public

Public client certificate: client certificate

Client private key: client key

Note

1. Before the client connects to the server, the Ca certificate, the client certificate, the client key, the TLS authentication key, these need to be provided by the server.
2. After obtaining the certificate file, copy the different certificate contents into the edit box corresponding to the configuration interface.

3.4.9.5. GRE

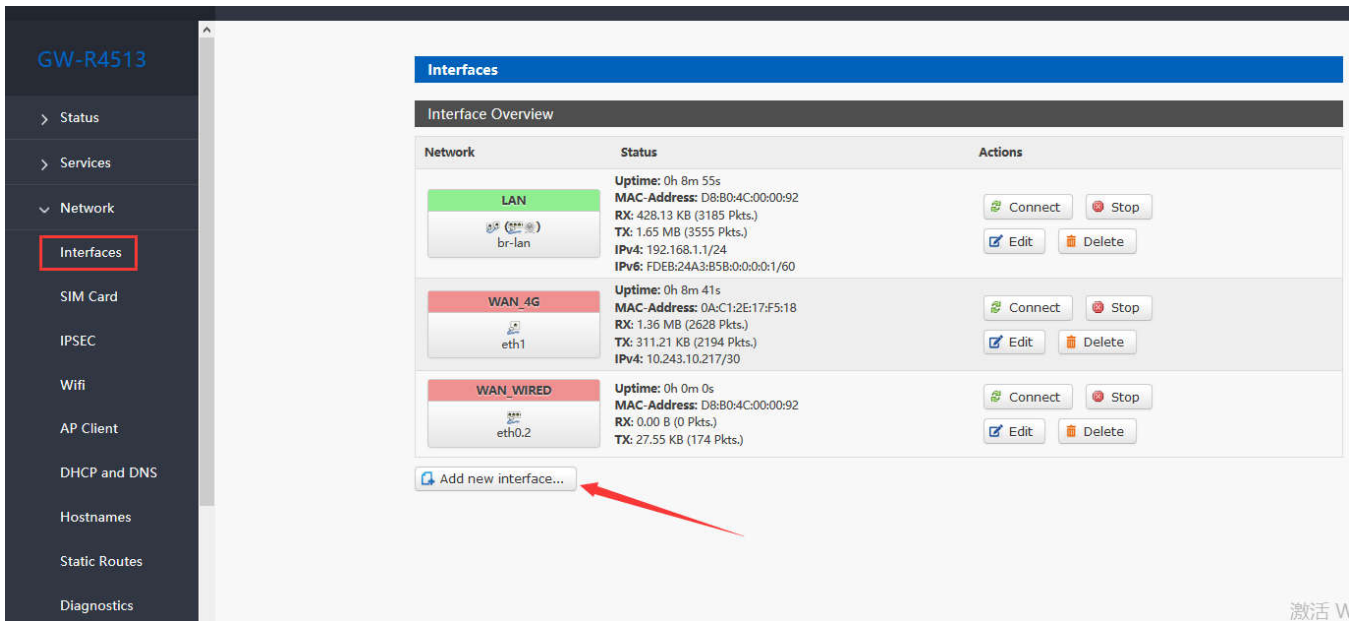

Figure42 add new interface

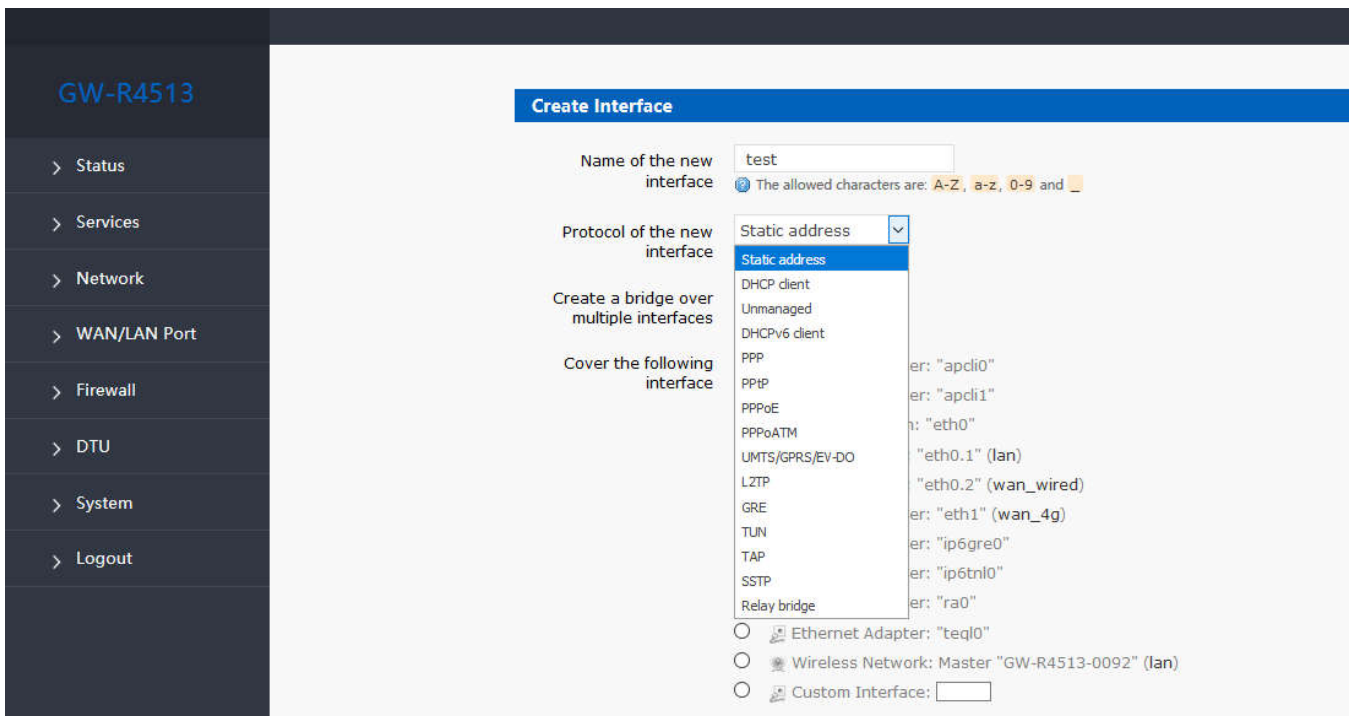

Figure43 add GRE interface

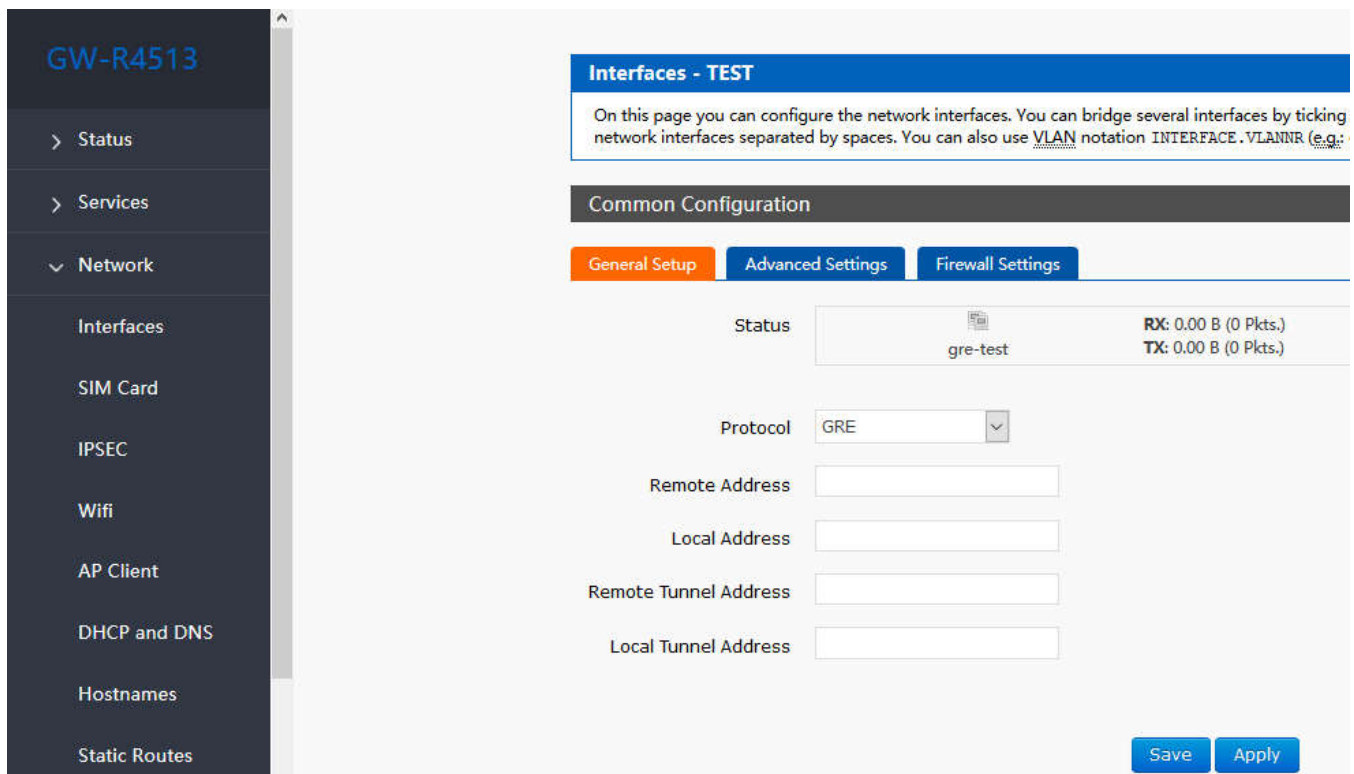

Figure44 GRE general setting

Remote address: IP address for WAN port of terminal GRE

Local address: the local address of wan_wried and wan_4g, users need fill in one of them accodeing to need.

Remote Tunnel Address: the opposite GRE tunnel IP address , and the setting of subnet masks can be expressed as follows:

255.0.0.0 can be written as IP/8, 255.255.0.0 can be written as IP/16, 255.255.255.0 can be written as IP/24, 255.255.255.255 can be written as IP/32

For example, 172.16.10.1/24

Local tunnel IP: local GRE tunnel IP address

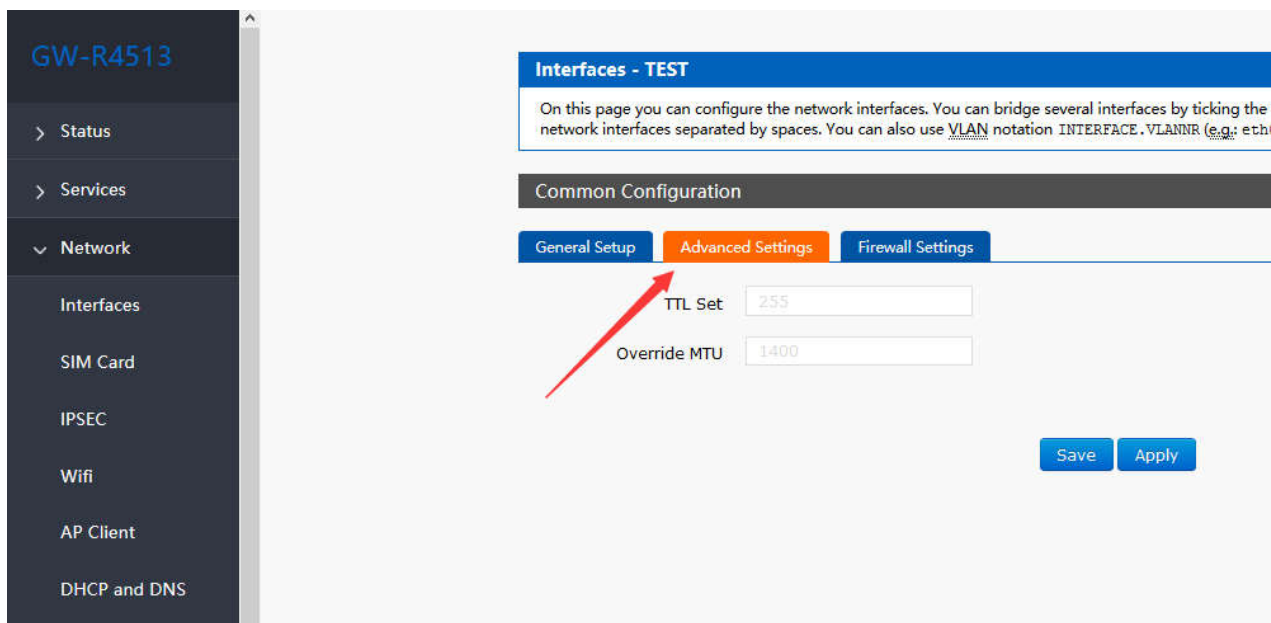

Figure45 GRE advance setting

TTL settings: set the TTL of the GRE channel, by default 255

Set MTU: set the MTU of the GRE channel, by default 1400

3.4.9.6. SSTP Client

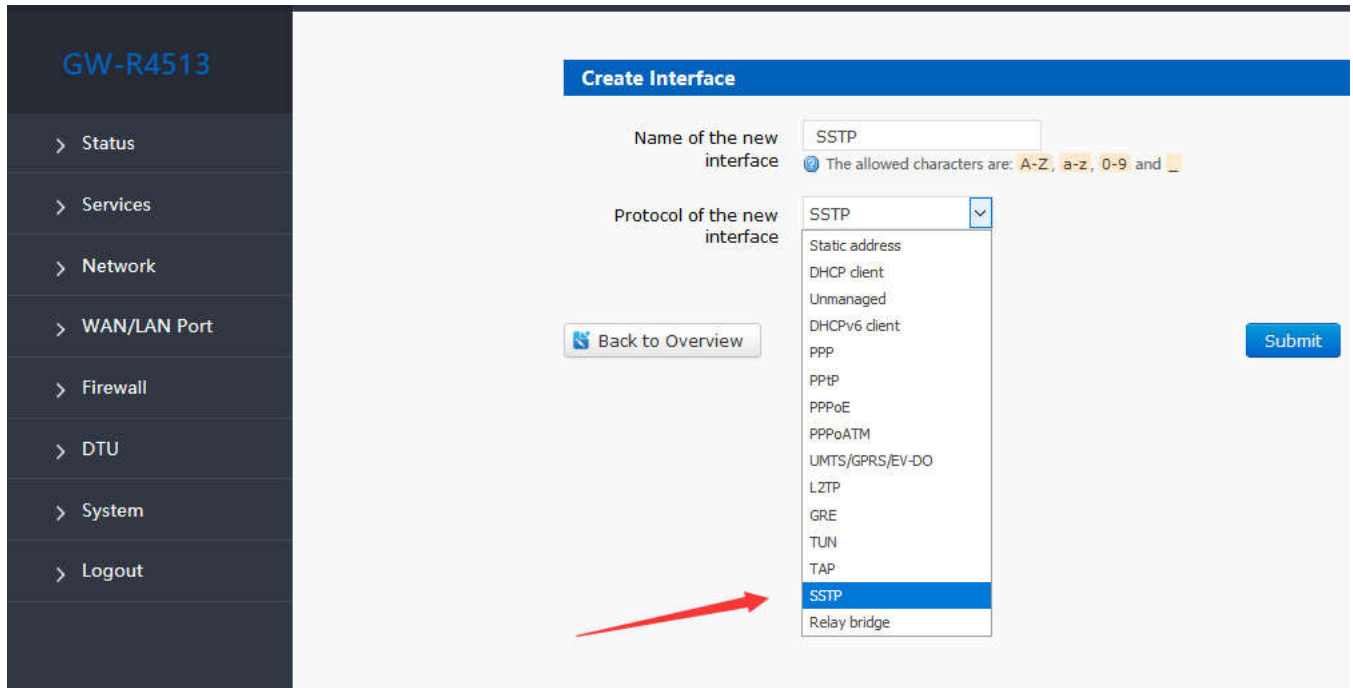

Figure46 add new interface

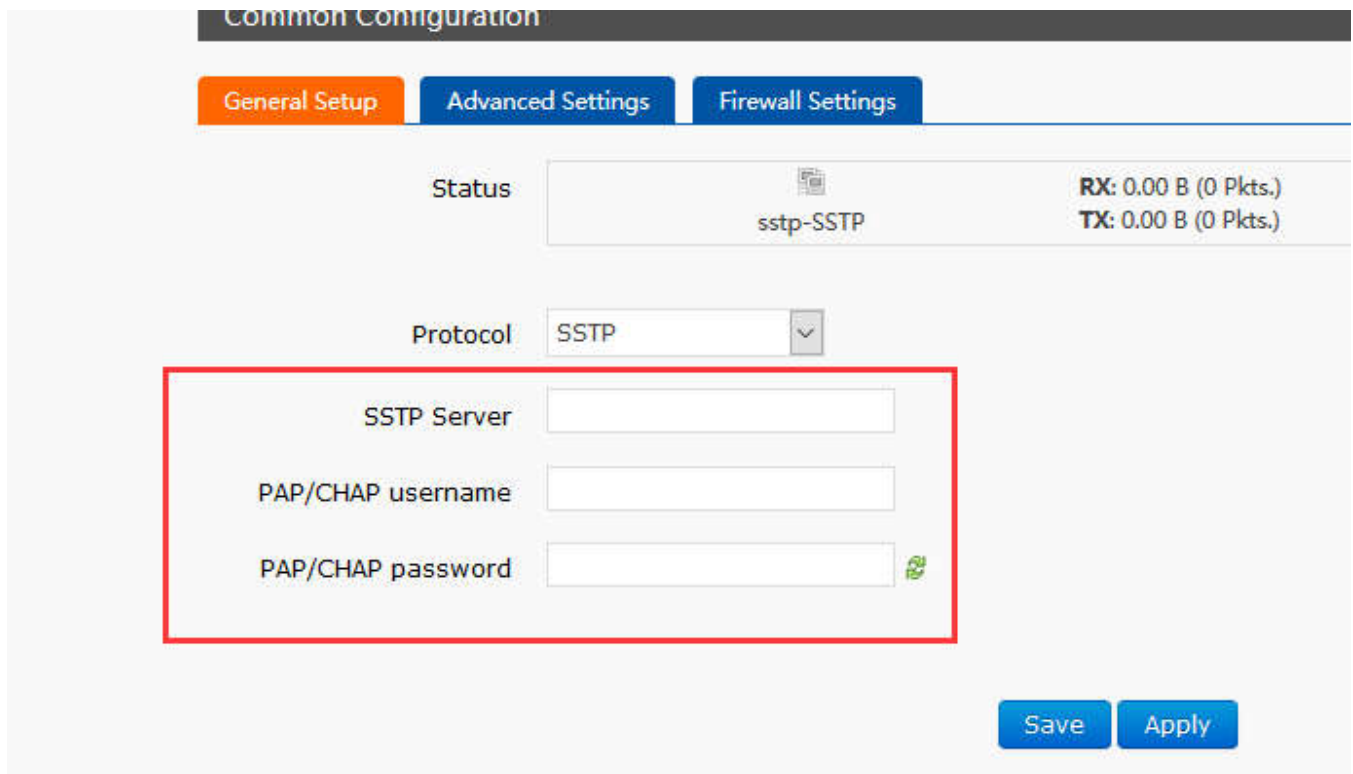

Figure47 SSTP general setting

SSTP server: the IP or domain name of the SSTP server.

PAP/CHAP Username: user name of SSTP

PAP/CHAP password: the password of SSTP

Note

Advanced settings can refer to advanced settings of PPTP.

3.4.10. Static Router

Table9 static router parameter

Name	Info	Note
Interface	Port for executing rules	eth0.2
Remote IP	Remote IP or address	192.168.1.0
Subnet	The remote subnet	255.255.255.0
Gateway	Address to be forwarded to	192.168.0.202
Metric		0
MTU	Maximum transmission unit	1500

Static routing describes the routing rules of Ethernet packets.

3.4.11. NAT Function

3.4.11.1. MASQ

MASQ, MASQUREADE, address masking, will leave the packet source IP into a router interface IP address, such as check IP dynamic masking, the system will flow out of the router packet source IP address changed to WAN port IP address.

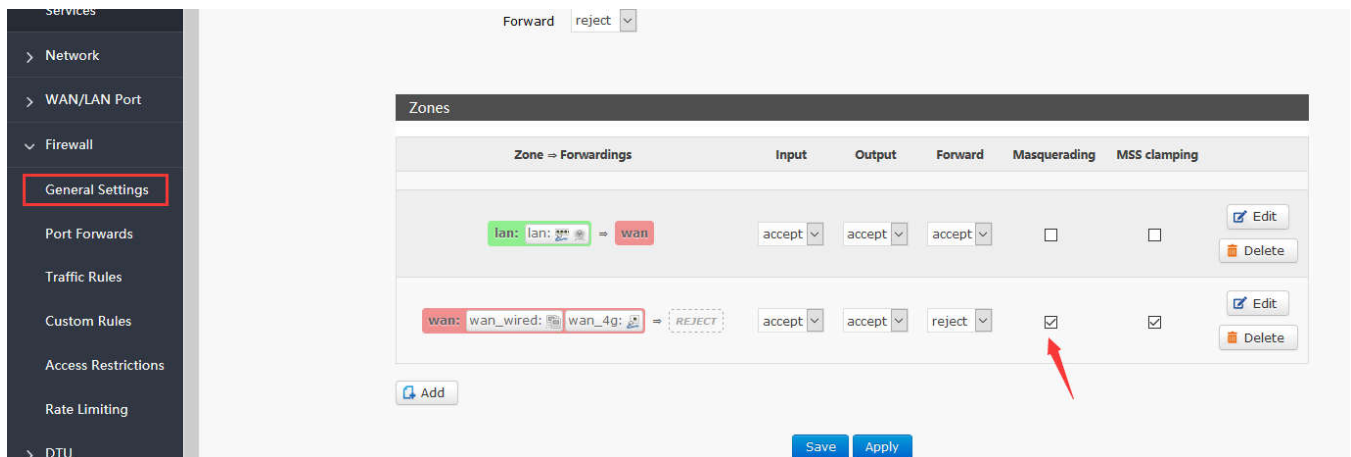
Figure48 MASQ setting

3.4.11.2. SNAT

Source NAT changes the source address of the packet leaving the router, closing the IP dynamic camouflage of the

WAN port first when used.

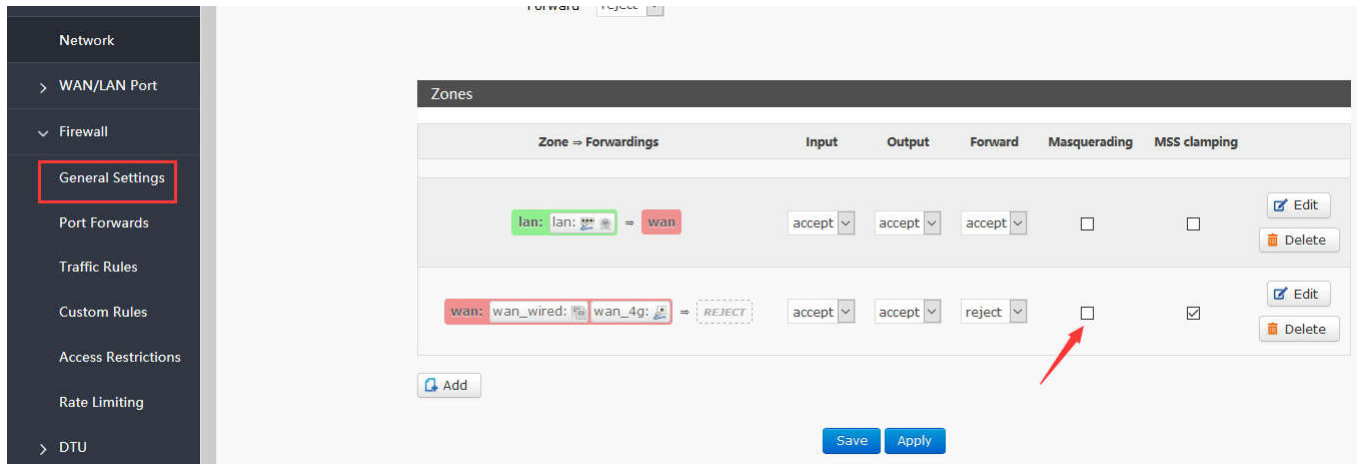

Figure49 close MASQ

Then setup SourceNAT.

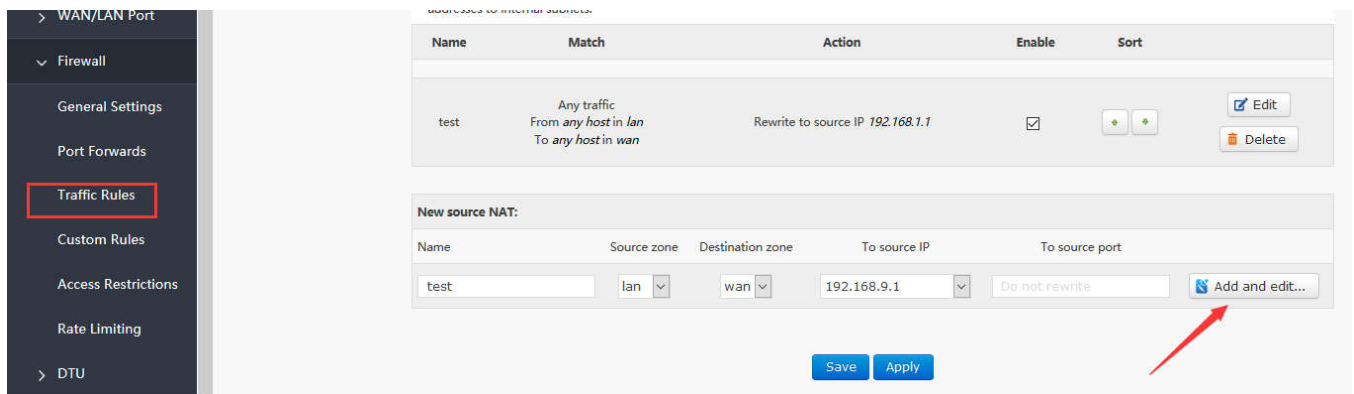

Figure50 NAT setting1

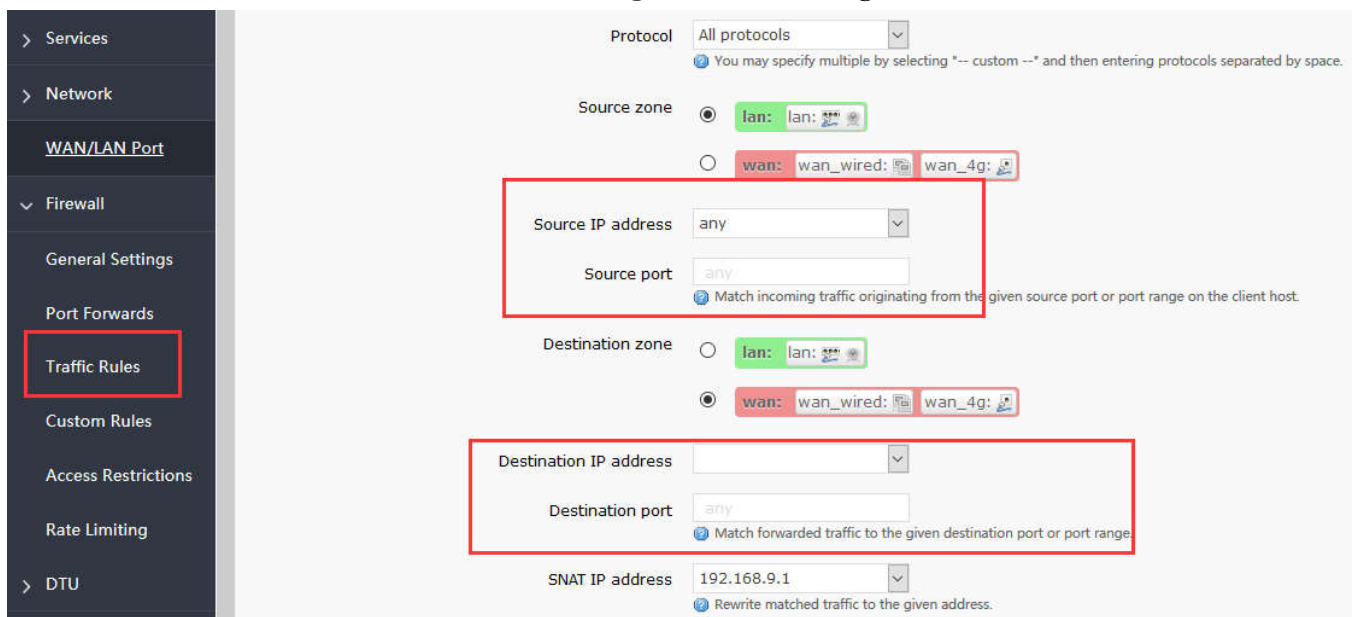

Figure51NAT setting2

Keep the source IP, port, the remote IP, port by default, then save.

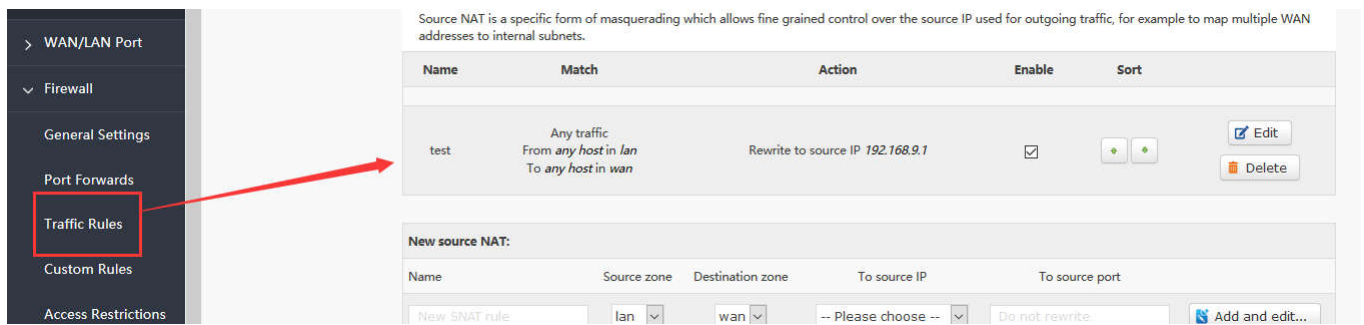

Figure52 NAT setting3

3.4.11.3. DNAT

DNAT is the replacement of destination addresses, replacing the destination IP address of packets that enter the router with the destination IP address of the WAN port IP with the user-set IP address

3.4.11.3.1. Port Forward

3.4.11.3.1.1. Introduce

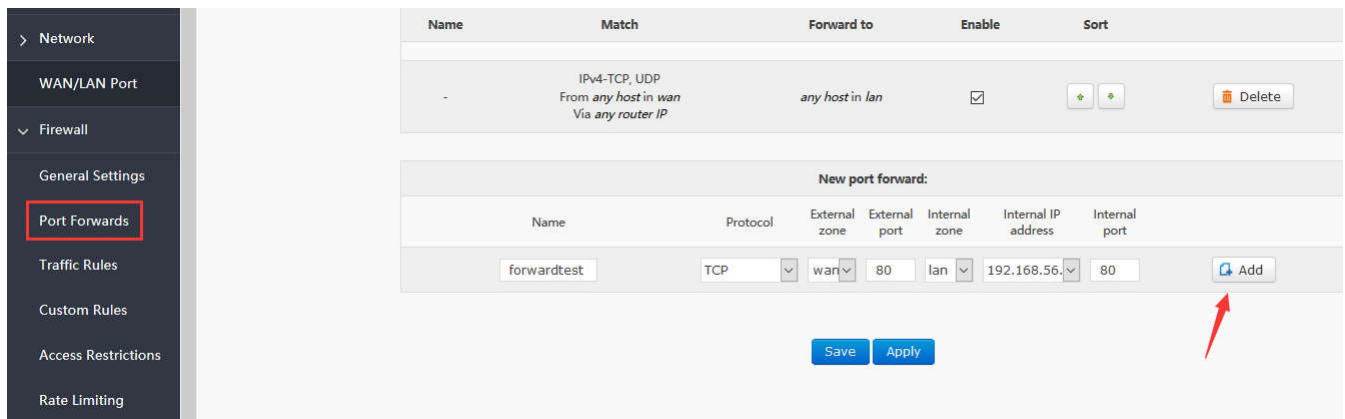

Figure53 port forward setting1

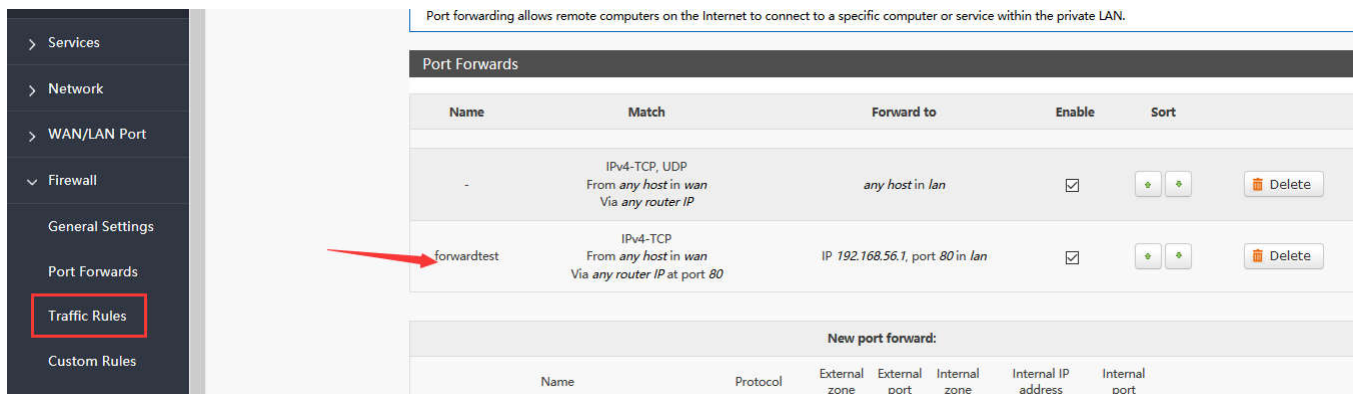

Figure54 port forward setting2

Then save the settings.

192.168.1.1:80 is the web server of routers. If we want to access a device in the LAN from the outside network, we need to set the mapping from the outside network to the inside network, such as setting the outside network port to 81, the inside network IP 192.168.1.1, and the inside network port to 80.

When we access the 81 port from the WAN port, the access request will be transferred to 192.168.1.1:80.

3.4.11.3.1.2. Port Forward on 4G Interface

Table9 port forward parameter

Use environment	Content	Info
Router	4G router	
	SIM card	APN card (IP: 10.201.20.47)
PC	IP of PC in LAN	192.168.1.247
	Listing port of PC	12129

First, fill in the APN address on router.

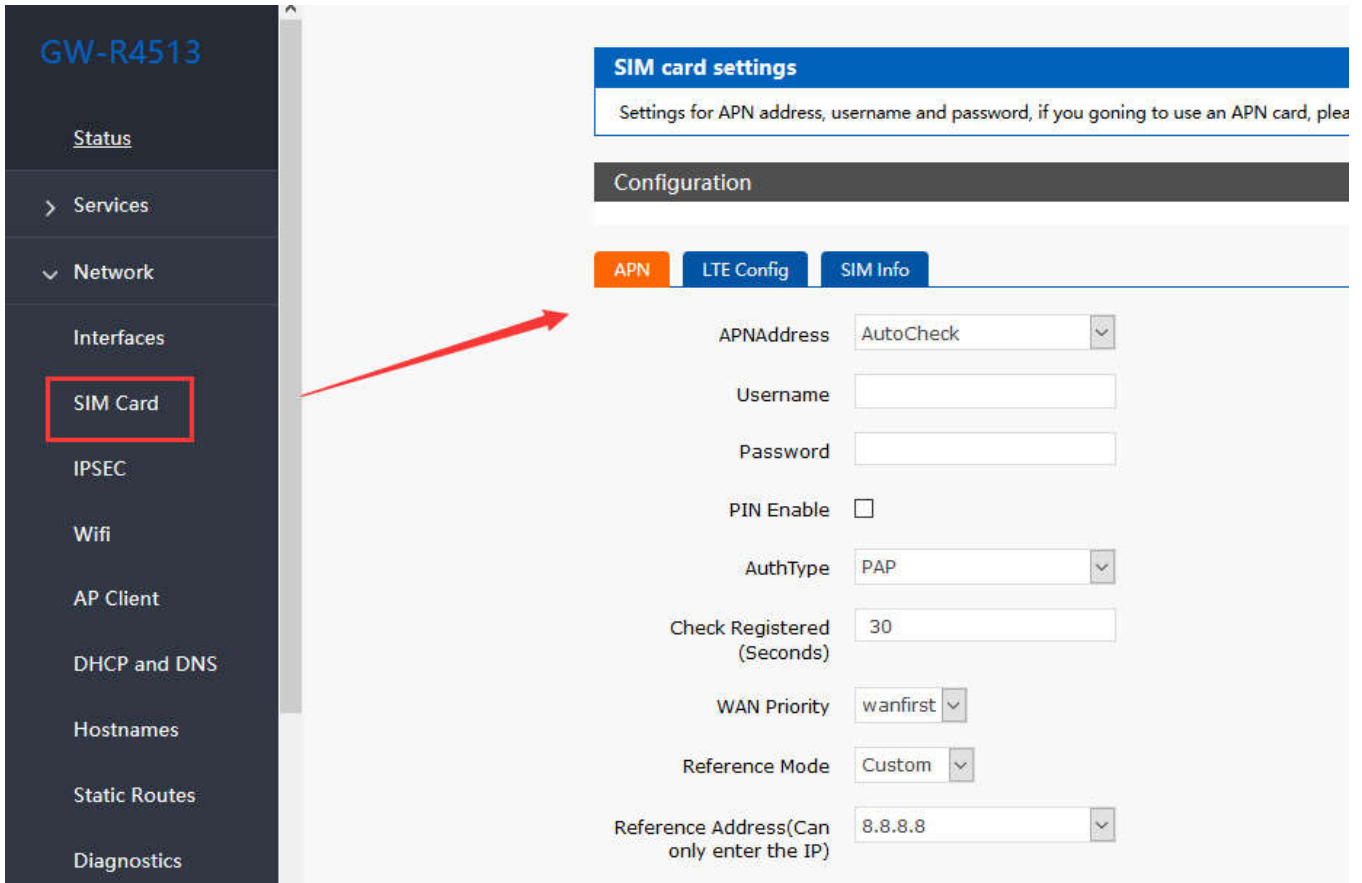
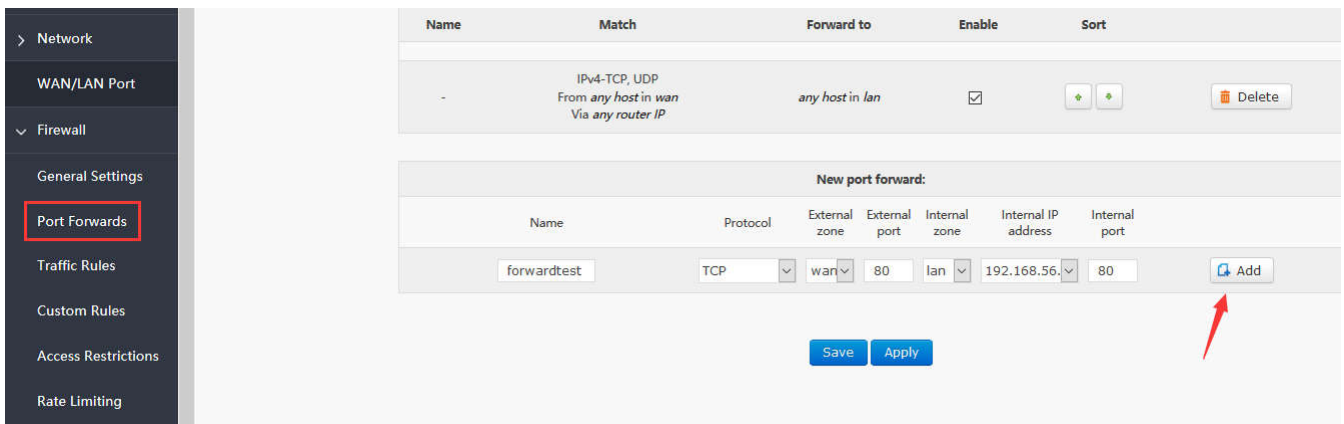

Figure55 4G port forward setting1

Then, add the port forward.

Figure56 4G port forward setting2

After setup all parameters, restart the router.

3.4.11.3.2. NAT DMZ

Port mapping is to map a specified port of WAN port address to a host in the intranet. DMZ function maps all ports of WAN port address to a host. Setting interface and port forwarding are in the same interface. When setting up, the external port is not filled in.

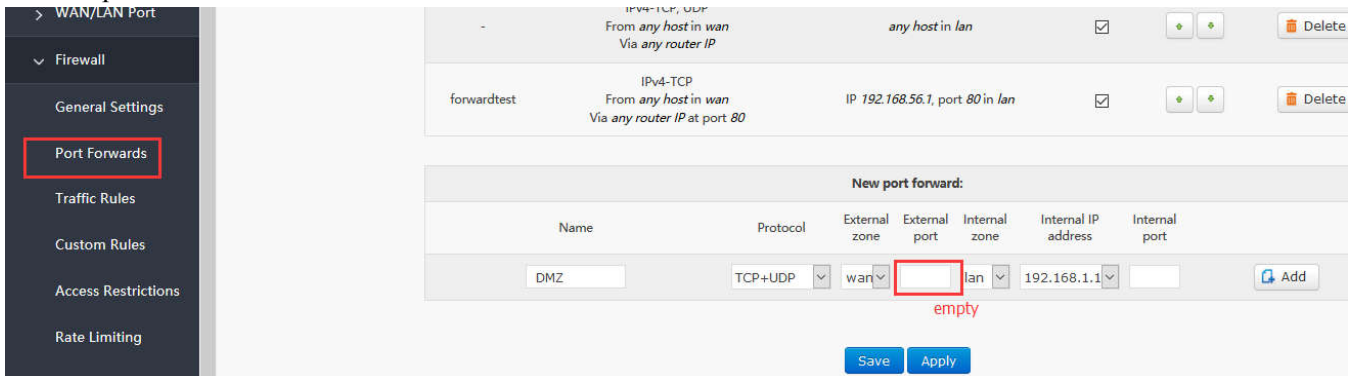
Figure57 DMZ setting1

Then add and save.

Figure58 DMZ setting2

As shown, all ports of the WAN address are mapped to the host 192.168.1.10 of the intranet.

Note

Port mapping and DMZ functions can't be used at the same time.

3.4.12. Access Restrictions

Access restriction implements the access restriction to the specified domain name, supports the blacklist and whitelist settings of domain name addresses. When a blacklist is selected, the device connecting the router can't access the domain name of the blacklist, and other domain name addresses can be accessed normally. When a whitelist is selected, the device connecting the router can access the domain name of the whitelist only. This function is turned off by default

3.4.12.1. Domain Blacklist

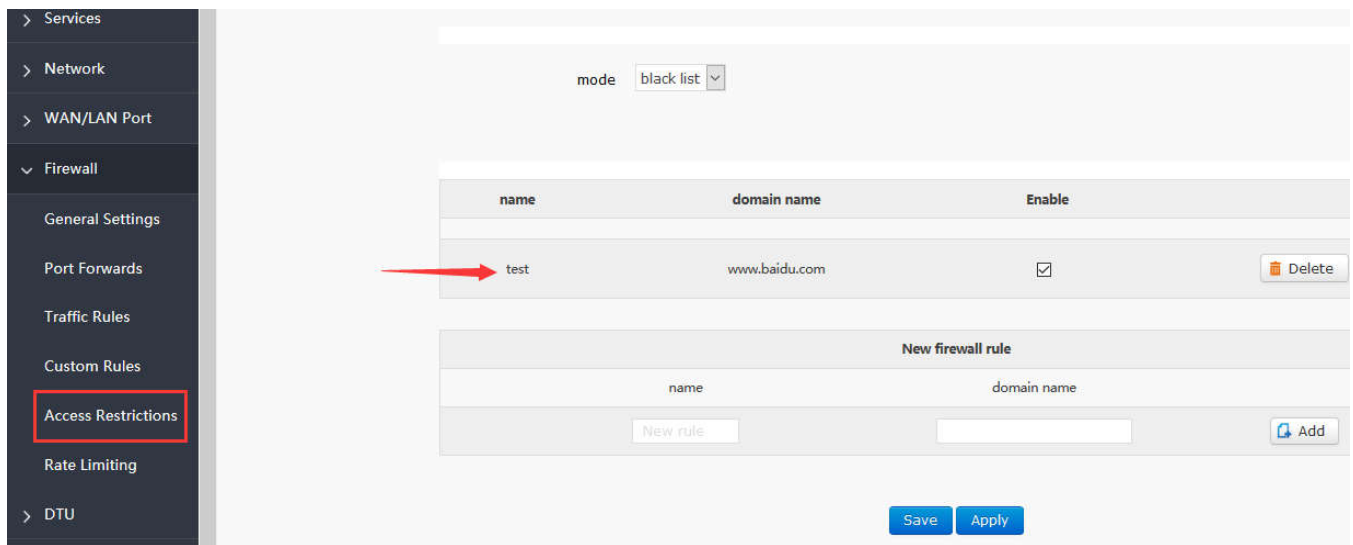

Figure59 blacklist

3.4.12.2. Whitelist

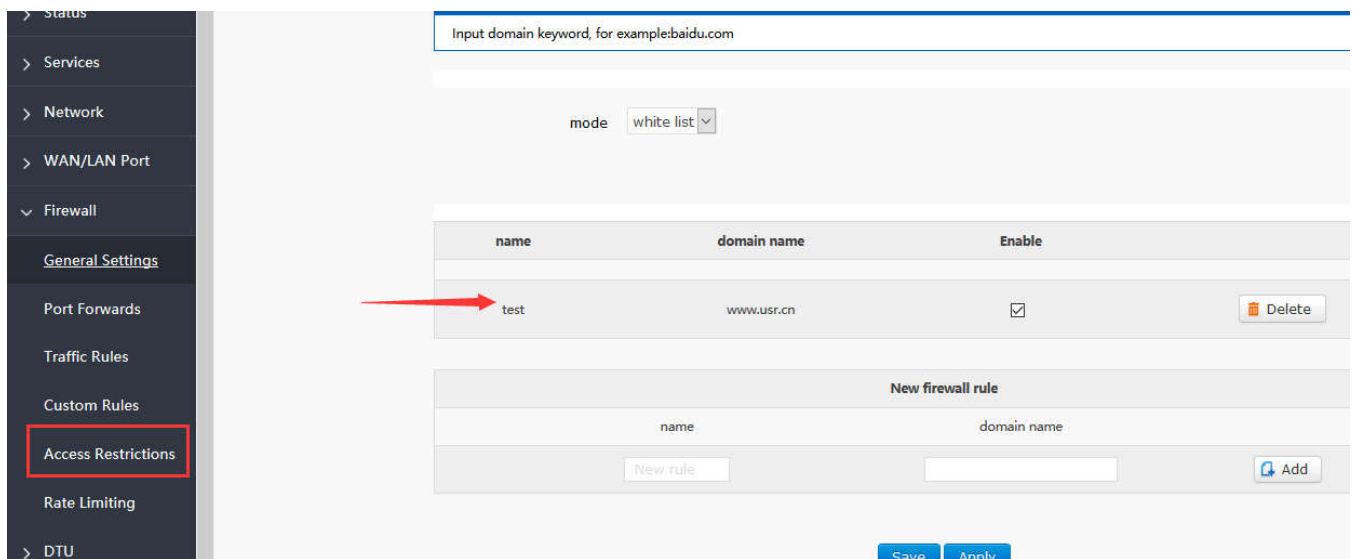

Figure60 whitelist

3.4.13. Rate Limiting

Network speed control can limit the speed of devices connecting to routers, support IP segment address speed limit and MAC address speed limit, and rules can be added at the same time.

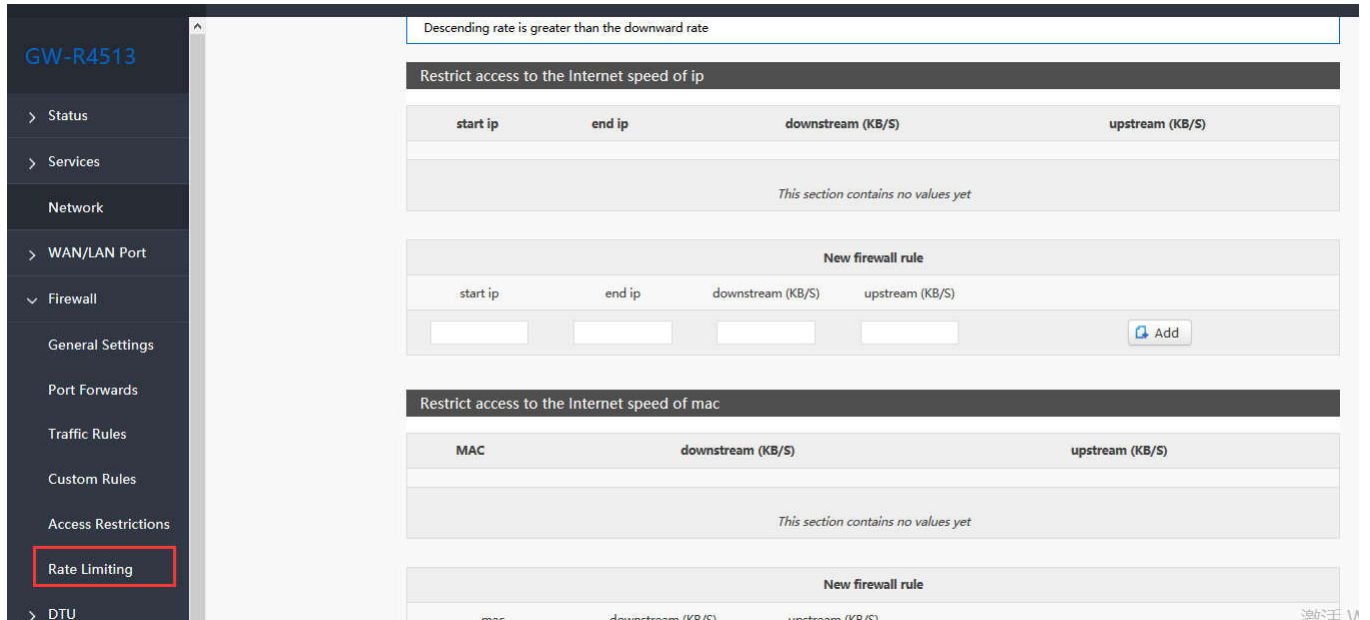

Figure61 rate limiting

4. DTU Function

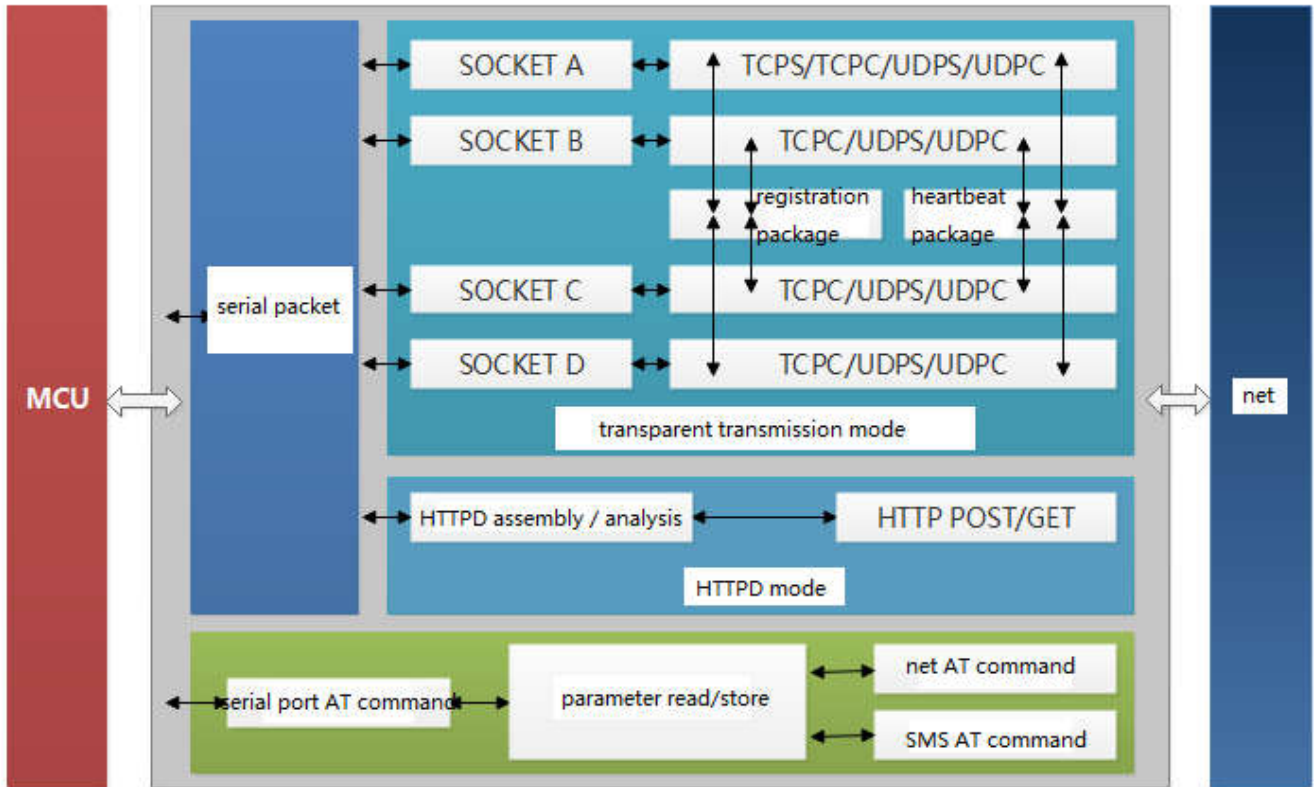

Figure62 DTU function

4.1. Work Mode

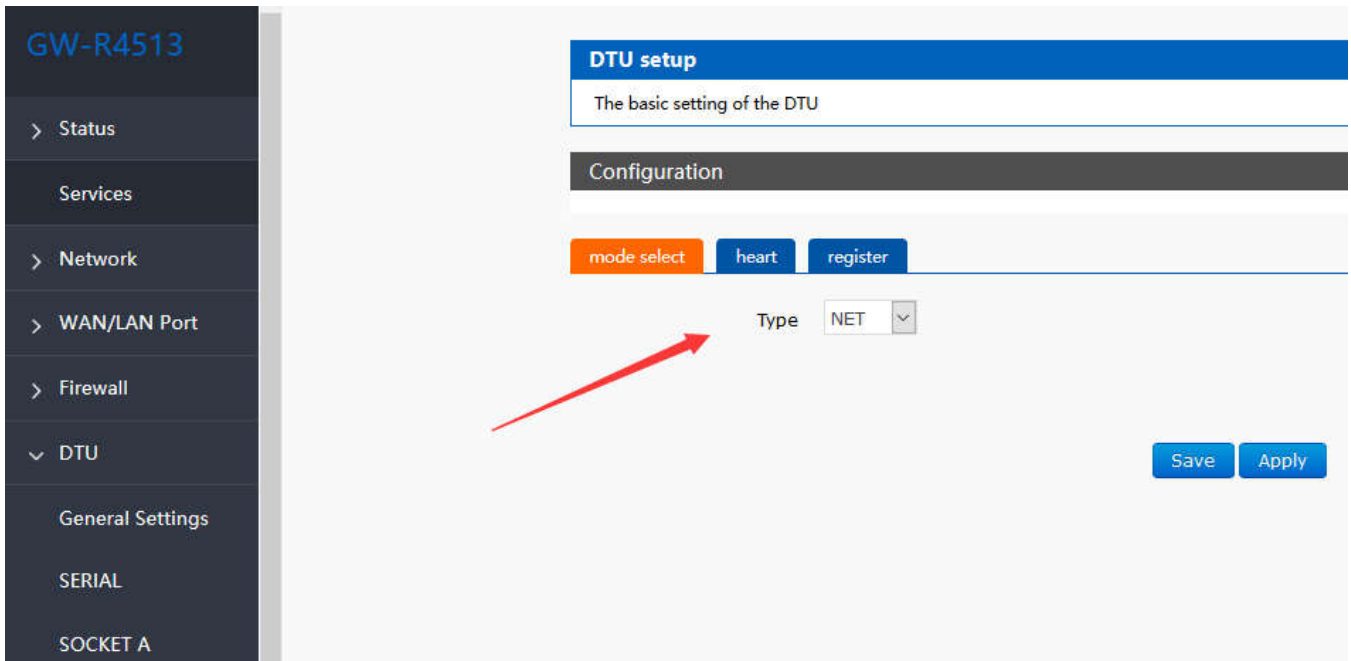

Figure63 mode select

4.1.1. Net Transparent Transmission Mode

4.1.1.1. Mode Declaration

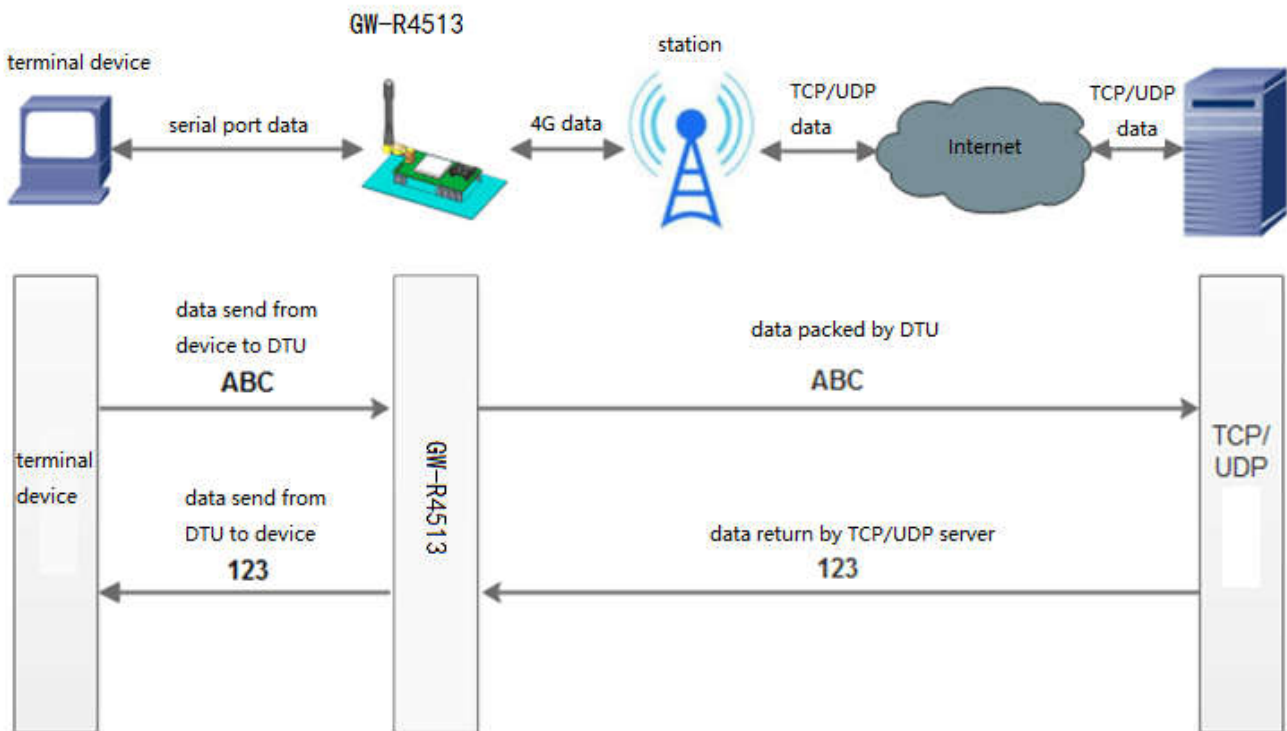

Figure64 net transparent transmission mode

GW-R4513 support 4 socket connection: socket A, socket B, socket C, socket D, they are independent of each other.

Socket A support: TCP Server、TCP Client、UDP Server、UDP Client

Socket B/C/D support TCP Client、UDP Server、UDP Client

The AT commands of setting:

1. Set the work mode :net transparent
AT+WKMOD=NET
2. Enable socket A
AT+SOCKAEN=ON
3. Setting socket A work at TCP Client mode
AT+SOCKA=TCPC, test.usr.cn,2317
4. Restart the module
AT+Z

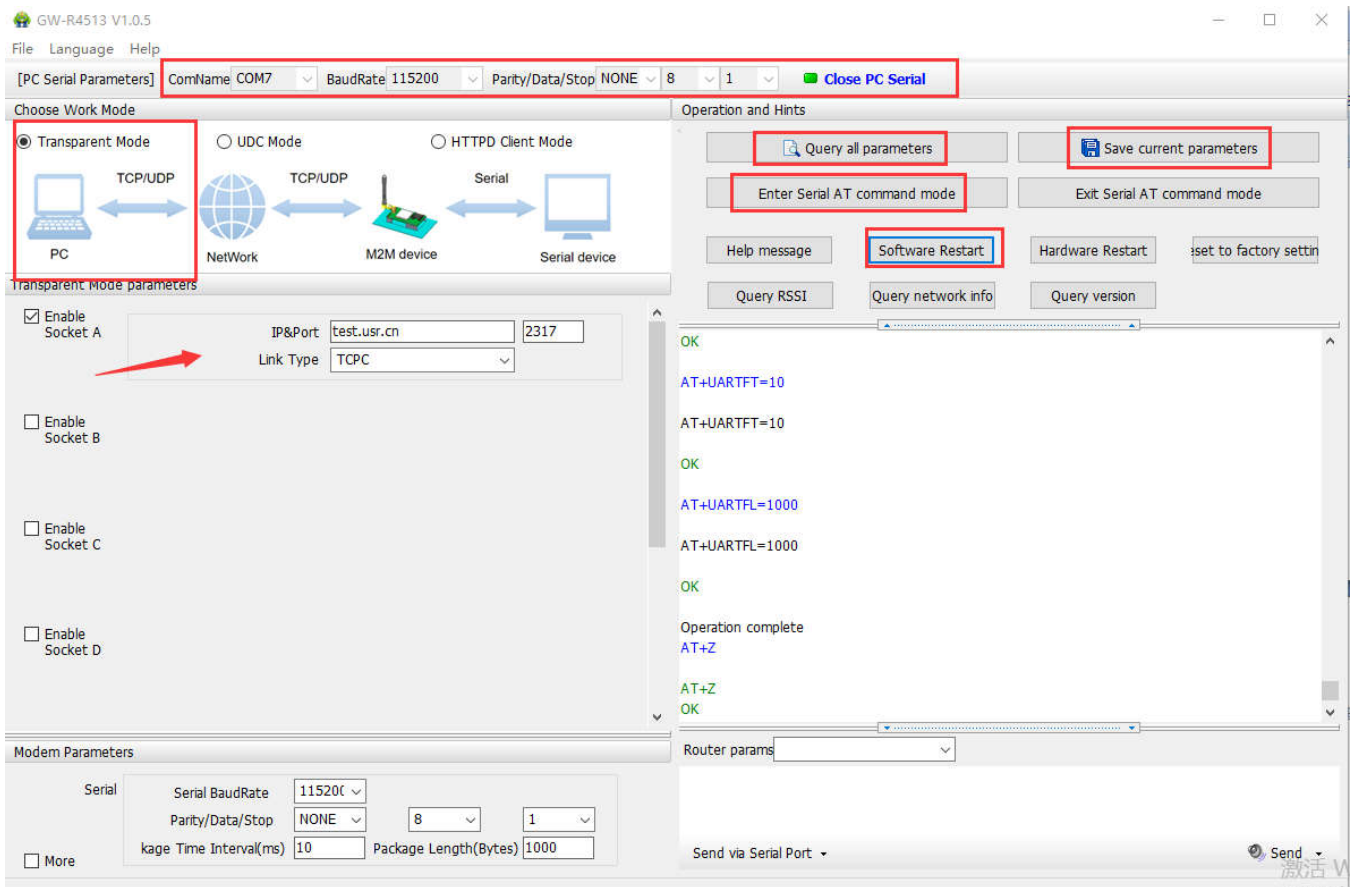

Figure65 setup software

4.1.2.HTTPD Mode

4.1.2.1. Mode Declaration

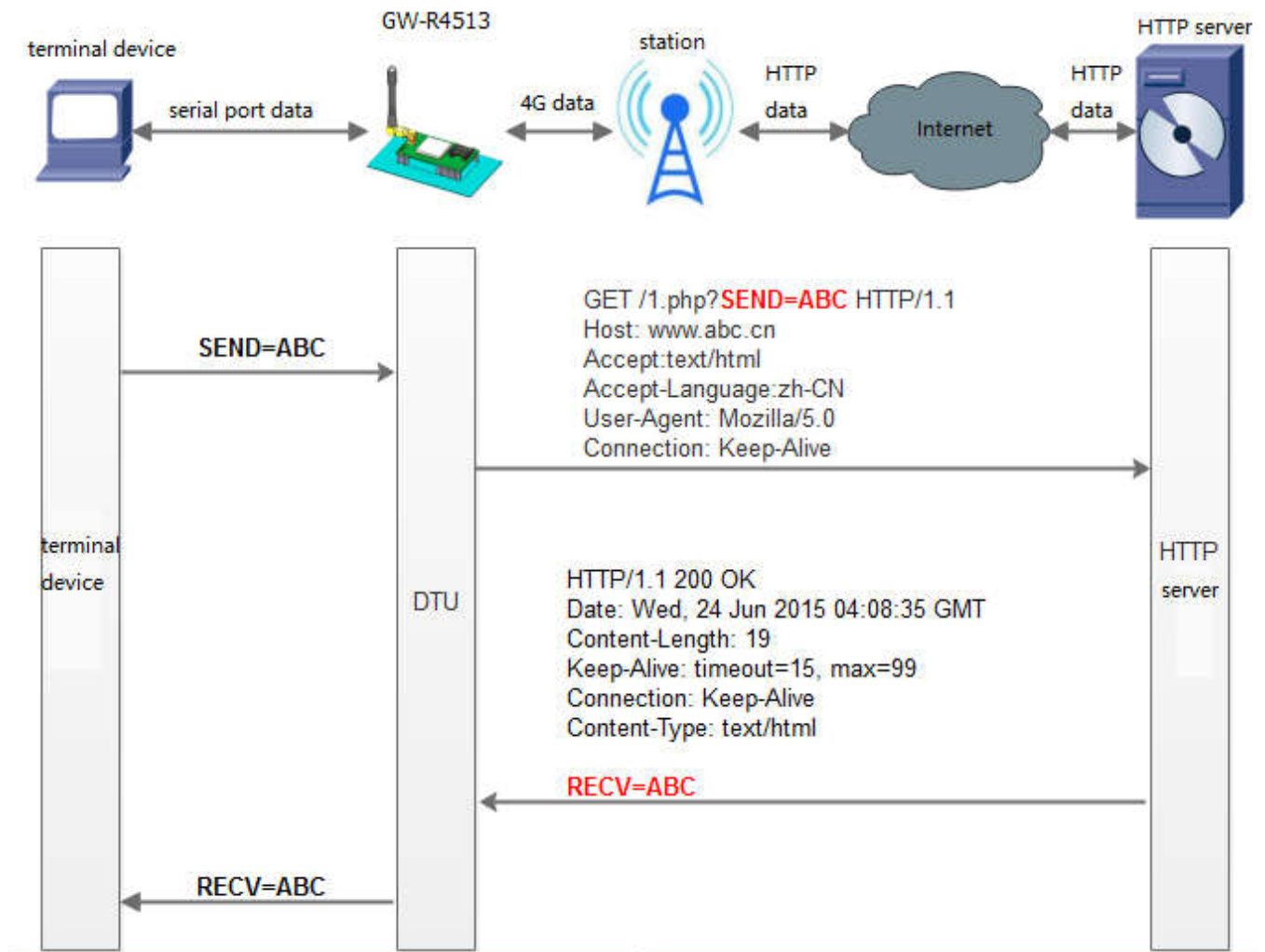

Figure66 HTTPD Mode

The AT commands of setting:

1. Set the work mode : HTTPD
AT+WKMOD=HTTPD
2. Set the type of request:
AT+HTPTP=GET
3. Set the URL
AT+HTPURL=/1.php[3F]
4. Set the server
AT+HTPSV=test.usr.cn,80
5. Set the head of HTTP
AT+HTPHD=Connection: close[0D][0A]
6. Set the overtime of request

AT+HTPTO=10

7. Set whether to filter information back to head

AT+HTPFLT=ON

8. Restart the module

AT+Z

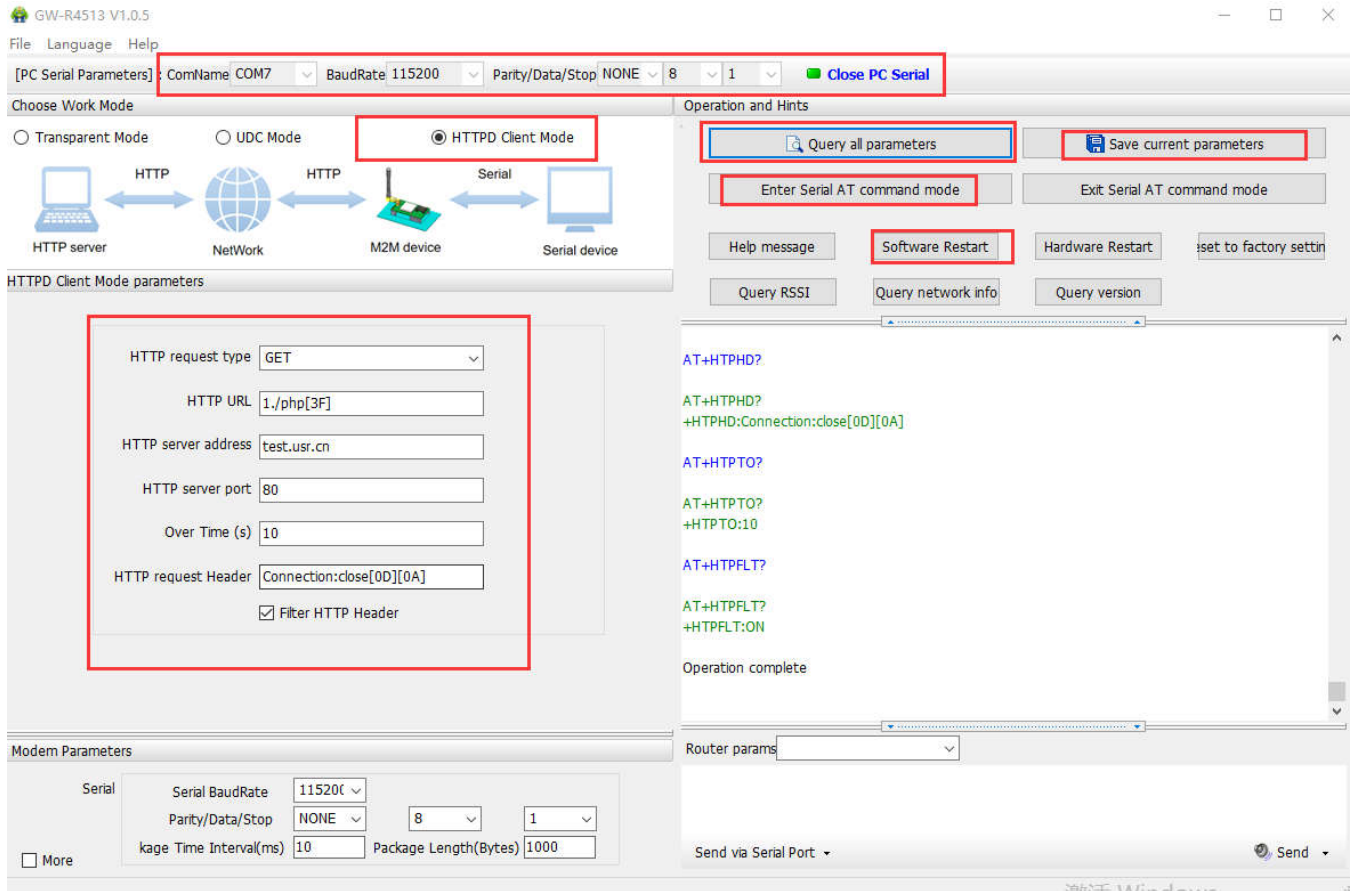

Figure67 setting software

4.1.3.UDC Mode

4.1.3.1. Mode Declaration

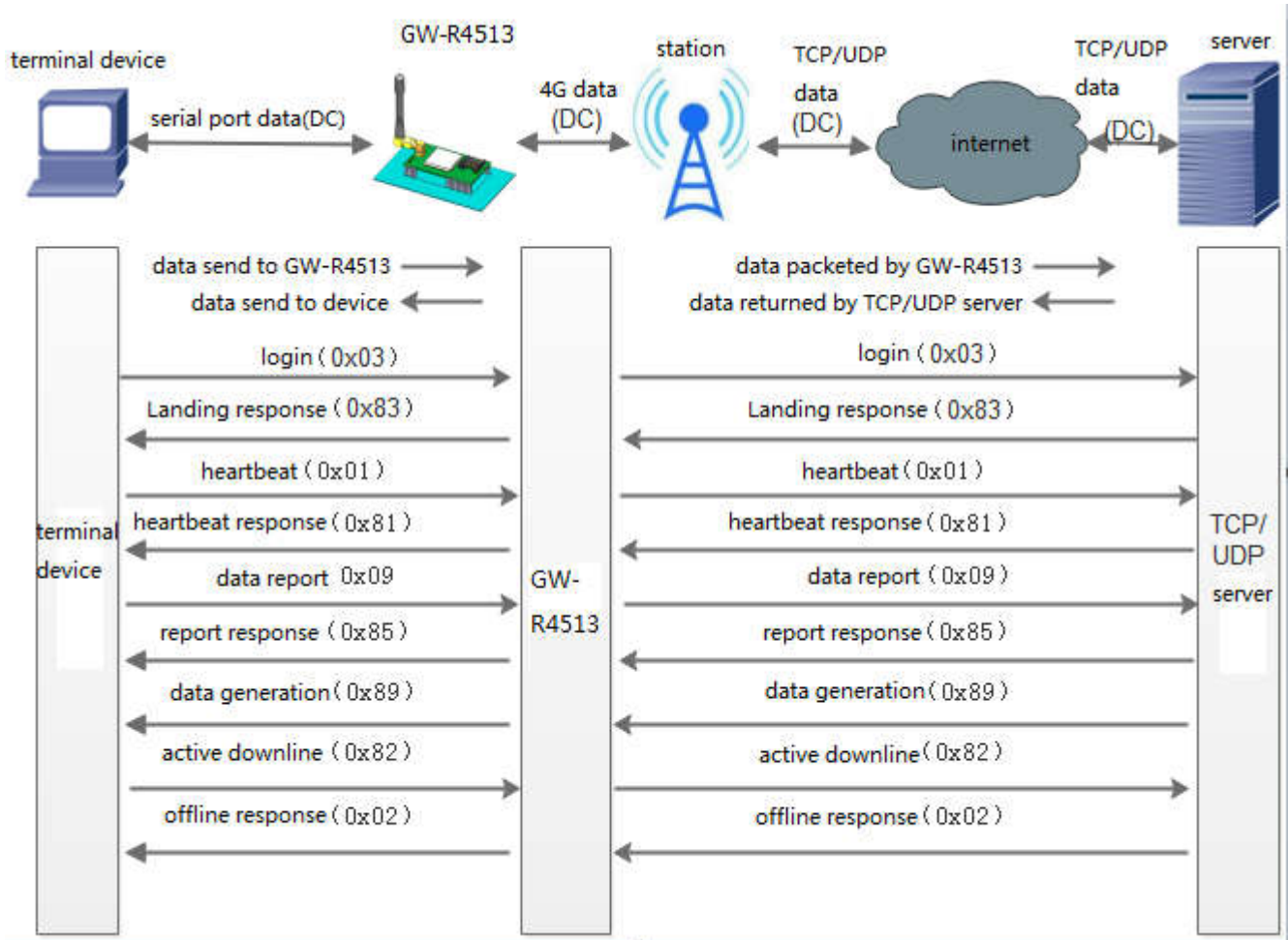

Figure68 UDC Mode

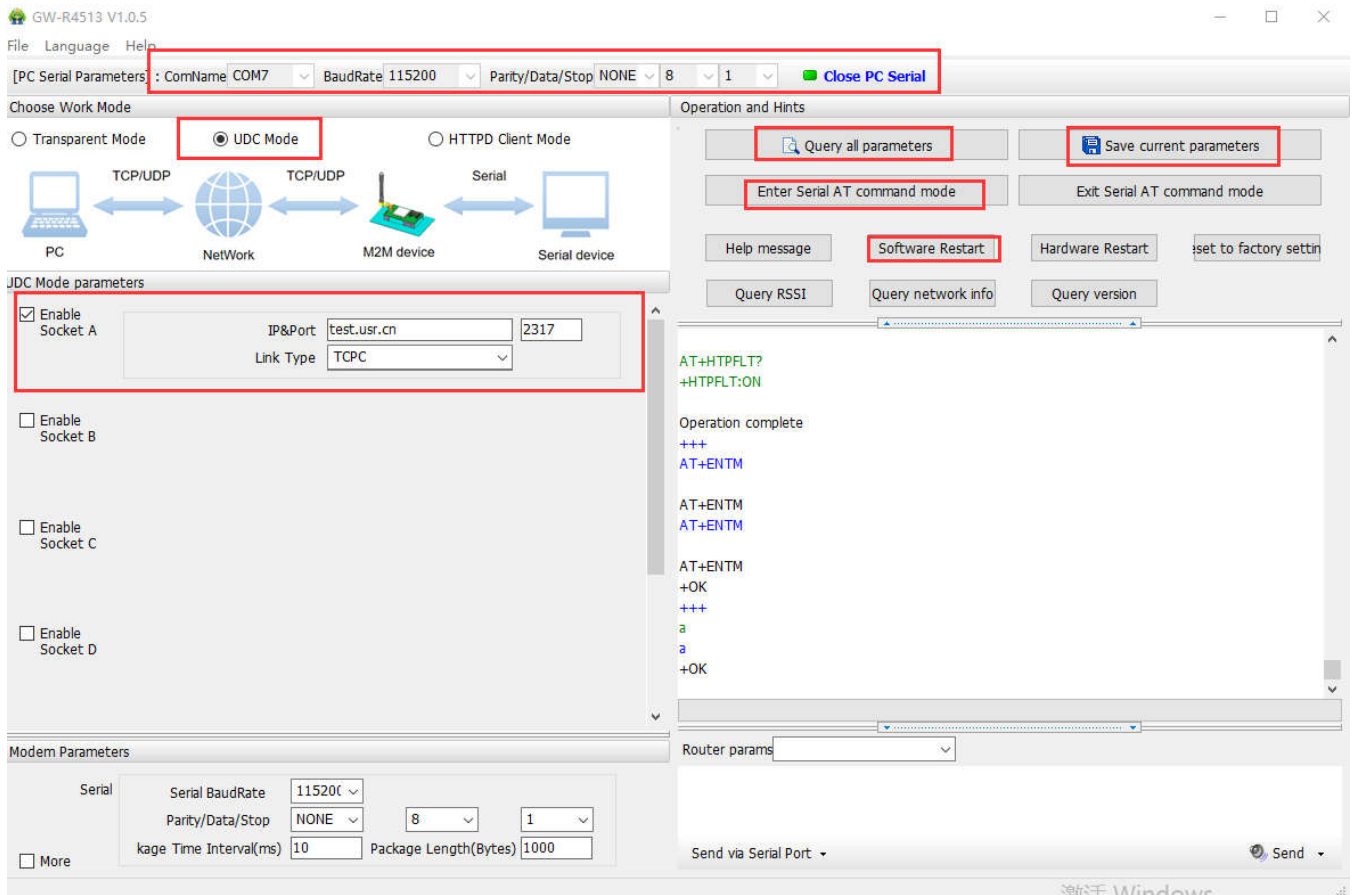

Figure69 setting software

The AT commands for setting GW-R4513:

1. Set the work mode: UDC
AT+WKMOD=UDC
2. Enable socket A
AT+SOCKAEN=ON
3. Set device work as TCP server, the server address is test.usr.cn, the port is 2317
AT+SOCKA=TCPC,test.usr.cn,2317
4. Enable heartbeat package
AT+HEARTEN=ON
5. Set the time interval
AT+HEARTTM=30
6. Enable registration package
AT+REGEN=ON
7. Set the registration mode: UDC
AT+WKMOD=UDC
8. Set the ID of UDC device
AT+UDCID=30303030303030303031
The ID parameter here is hex form.
9. Send save command
AT+S

4.2. Serial Port

4.2.1. Basic Parameters

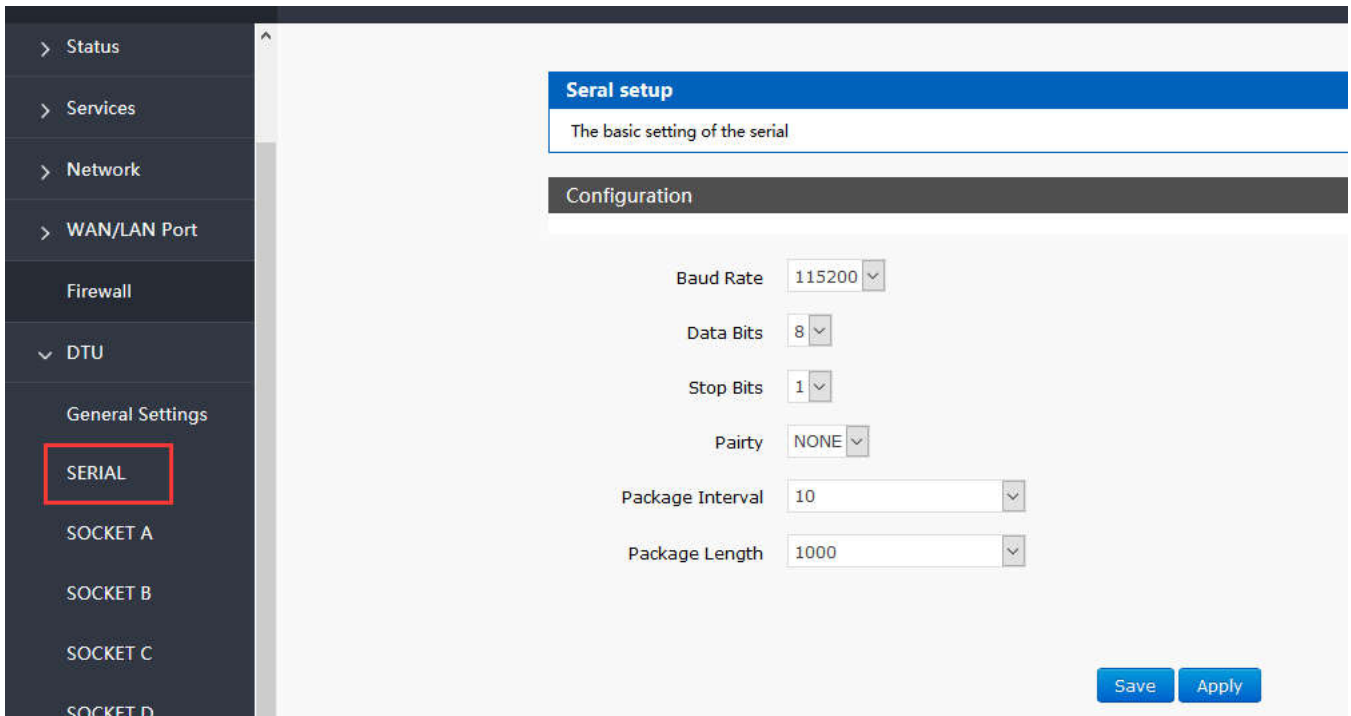

Figure70 serial port setting

Table10 serial port parameter

	Parameter
Baud rate	2400, 4800, 9600, 19200, 38400, 57600, 115200, 230400
Data bit	8
Stop bit	1,2
Check bit	NONE
	EVEN
	ODD
	MARK
485	NFC
	485 communication

4.2.2. Frame Forming Mechanism

4.2.2.1. Time Triggered Mode

When receiving data from UART, GW-R4513 continuously checks the interval between 2 adjacent bytes. If the interval

time is greater than or equal to a certain "time threshold", a frame is considered to end, otherwise data is received until it is greater than or equal to the packing length (default is 1000 bytes).The range can be set to be 10ms~60000ms. The default time is 10ms.

This parameter can be set accodeing to the AT command, AT+UARTFT=10.

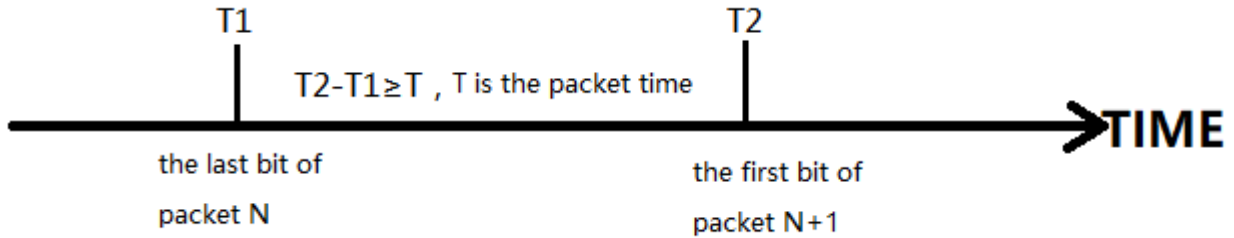

Figure71 time triggered mode

4.2.2.2. Length Triggered Mode

When receiving data from UART, GW-R4513 will check the number of bytes received continuously. If the number of bytes received reaches a certain "length threshold", it is considered that the end of a frame. The range of settings is 1~4096. Factory default 1000.

This parameter can be set accodeing to the AT command, AT+UARTFL=<length>

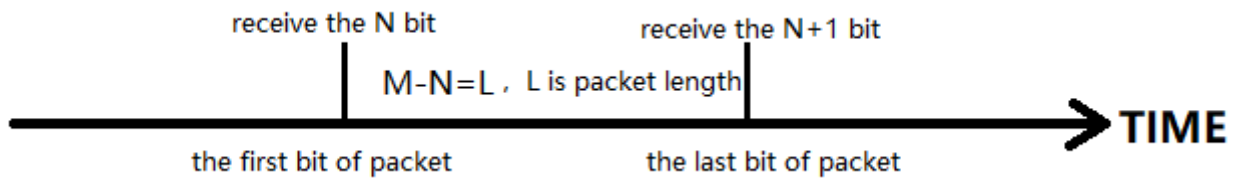

Figure72 length triggered mode

4.3. Characteristic Functions

4.3.1. Registration Package

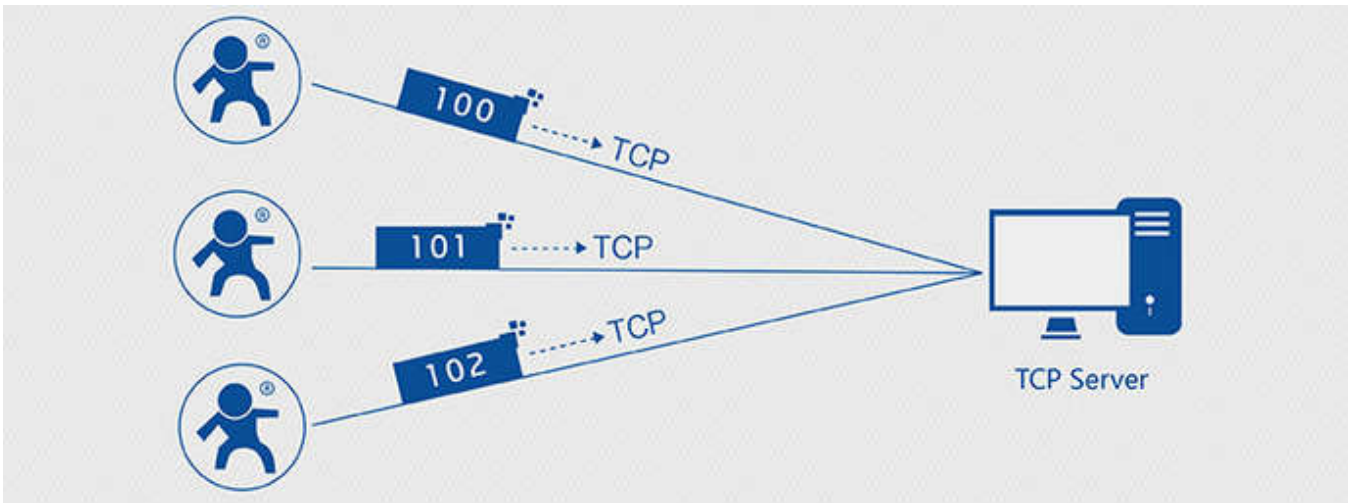

Figure73 registration package function

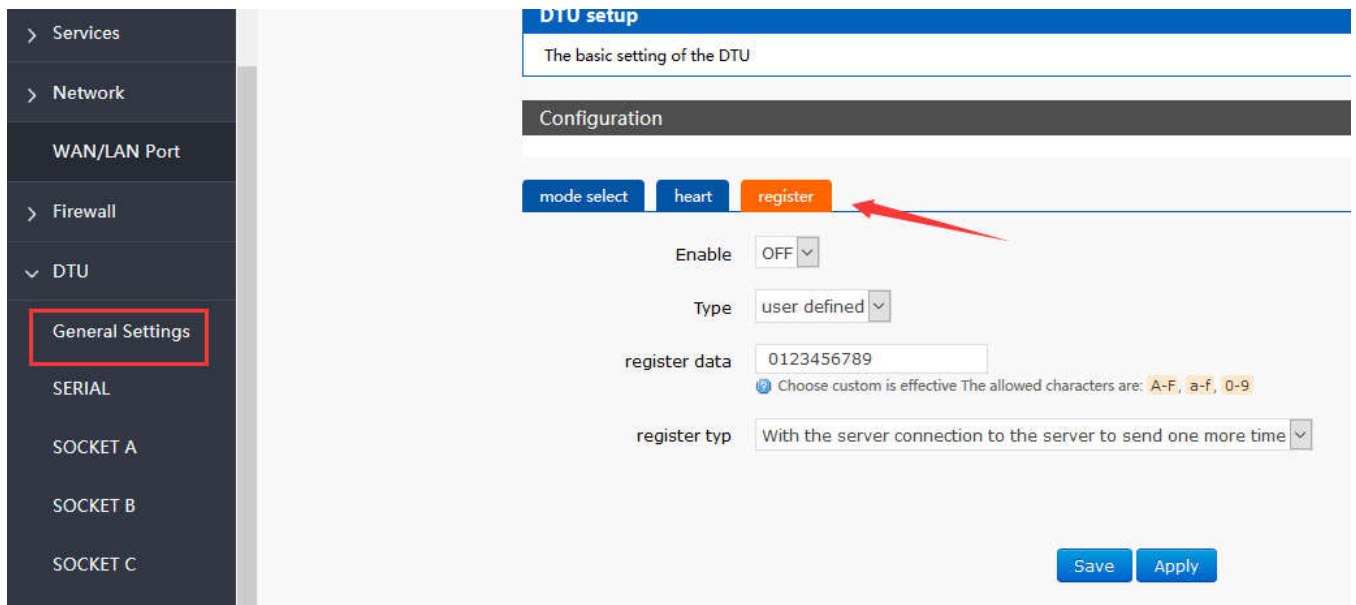

Figure74 registration package setting

When work at the net transparent transmission mode, the user can choose to send register package from device to server. The registration package is designed to enable the server to identify the data source device, or as a password to obtain authorization for the functions. Registered packets can be sent when a connection between the device and the server is established, or they can be spliced together at the front of each packet as a data package. The data of the registration package can be ICCID code, IMEI code, or custom registration data.

Table11 AT commands

Command	Function	Default parameter
AT+ REGEN	Query/set enable register function	OFF

AT+ REGTP	Query/set the type of register content	USER
AT+ REGDT	Query/set the info of custom register	0123456789
AT+ REGSND	Query/set register packet sending mode	DATA

AT commands

1. Enable register package
AT+REGEN=ON
2. Set the register type is custom define
AT+REGTP=USER
3. Set the data of register package
AT+REGDT=123456789
4. Setting up the registration package is to send registered data as the head of each packet data
AT+REGSND=DATA
5. Restart
AT+Z

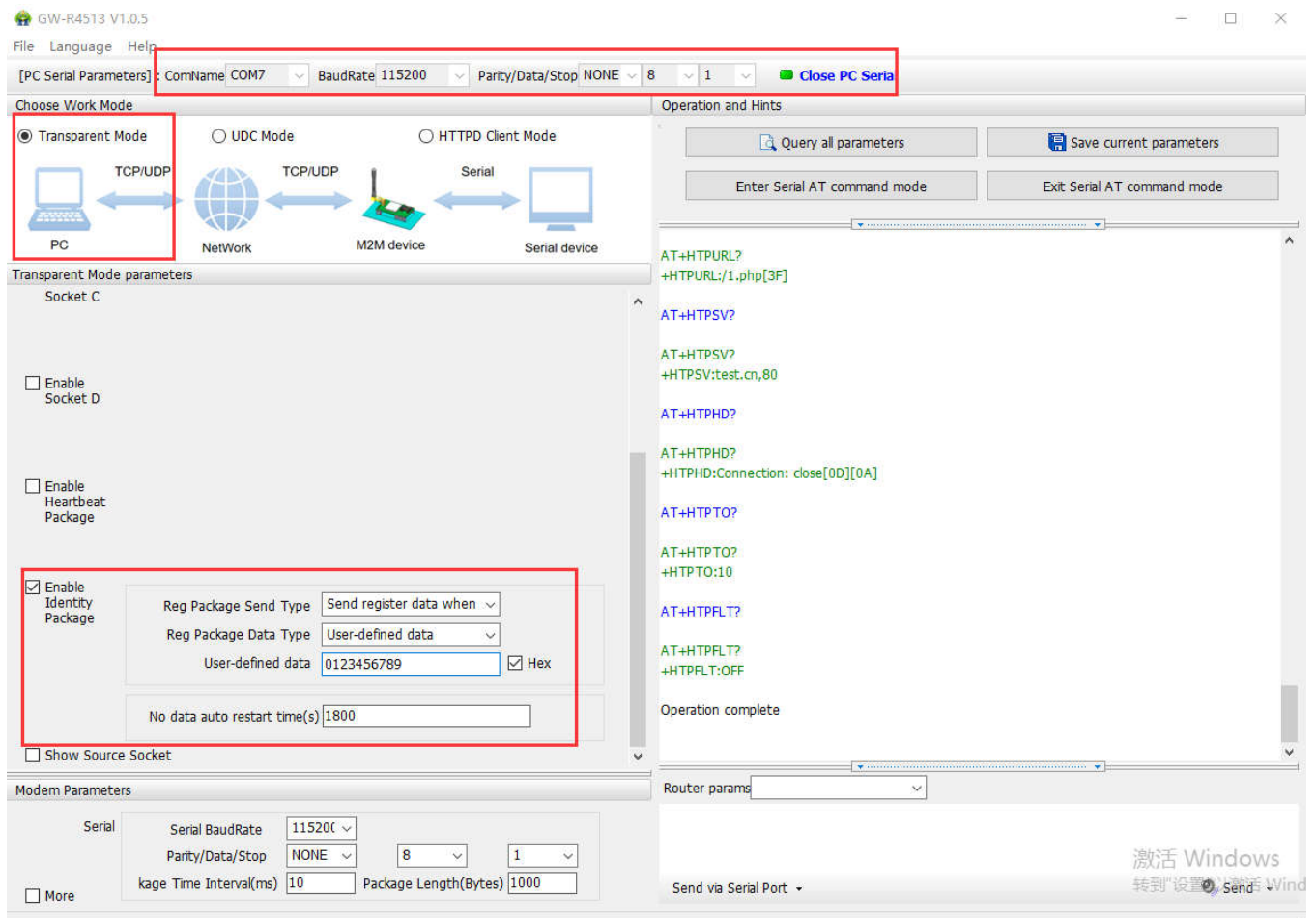

Figure75 setting software

4.3.2. Heartbeat Package

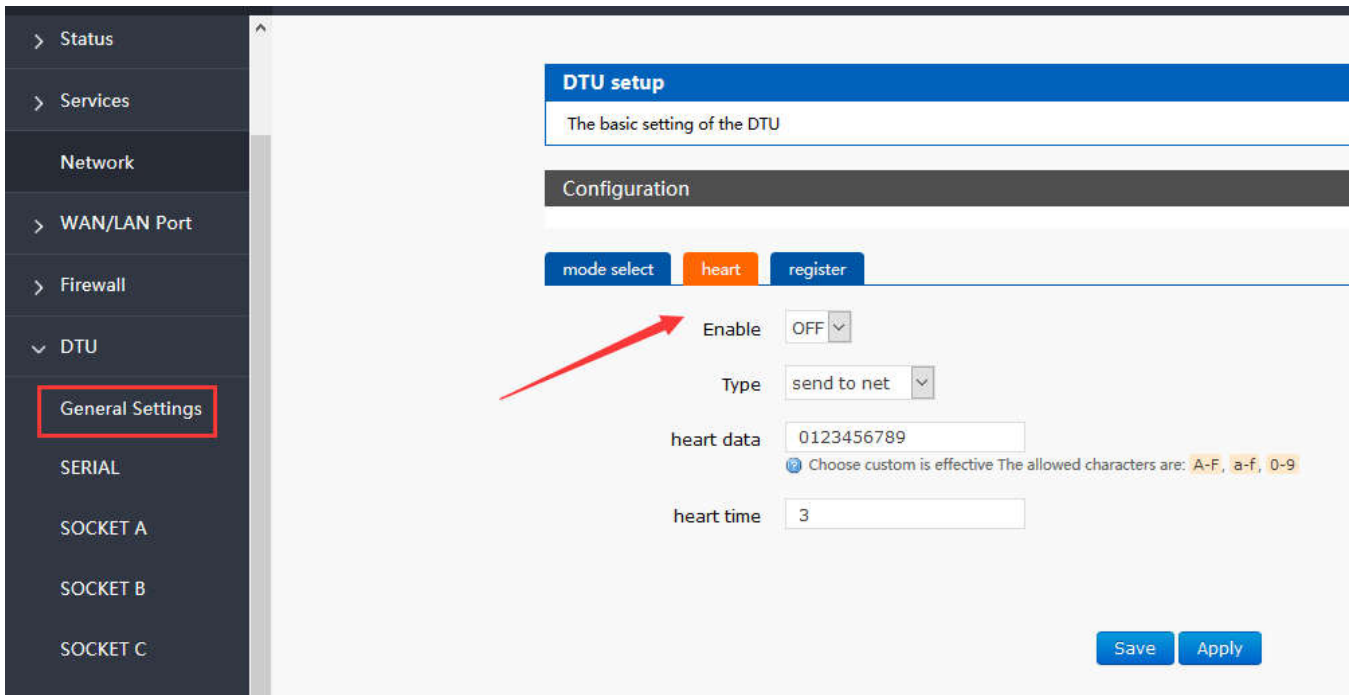

Figure76 heartbeat package setting

When work at net transparent transmission mode, the user can choose to send heartbeat packets to DTU. Heartbeat packets can be sent to the server side of the network, or to the device port of the serial port.

The main purpose of sending to the network side is to maintain the connection with the server.

In order to reduce communication flow, users can choose to send heartbeat packets (query instructions) to serial device instead of sending query instructions from server.

Table12 AT commands

Command	Function	Default parameter
AT+ HEARTEN	Query/set enable heartbeat package	OFF
AT+ HEARTDT	Query/set data of heartbeat package	0123456789
AT+ HEARSND	Query/set heartbeat sending type	NET
AT+ HEARTTM	Query/set transmission interval	30

AT commands

1. Enable heartbeat package:
AT+HEARTEN=ON
2. Set the heartbeat data
AT+HEARTDT=123456789
3. Set the heartbeat send to net port
AT+HEARTTP=NET
4. Set the transmission interval
AT+HEARTTM=30
5. Restart
AT+Z

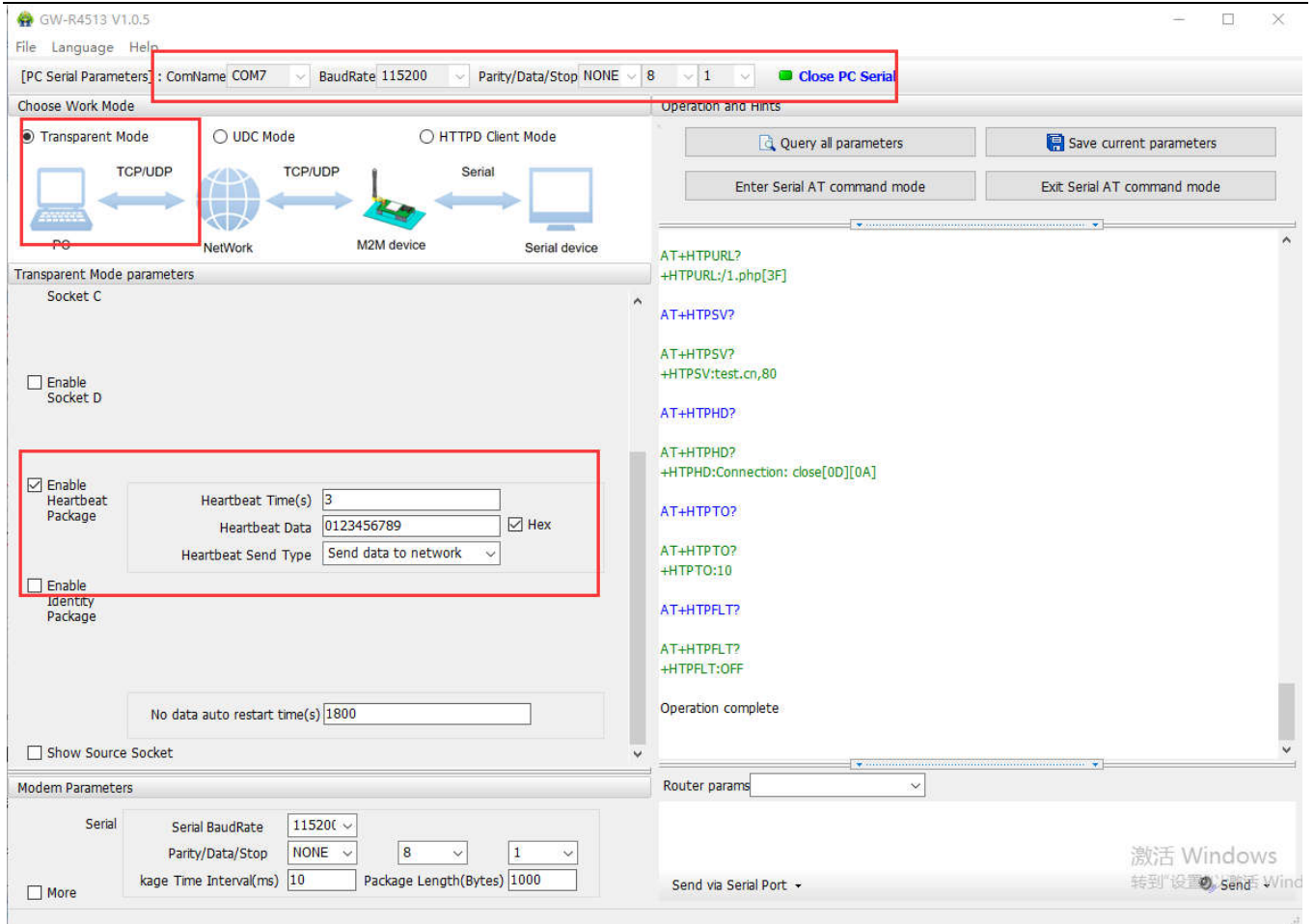

Figure77 setting software

4.3.3.USR-Cloud

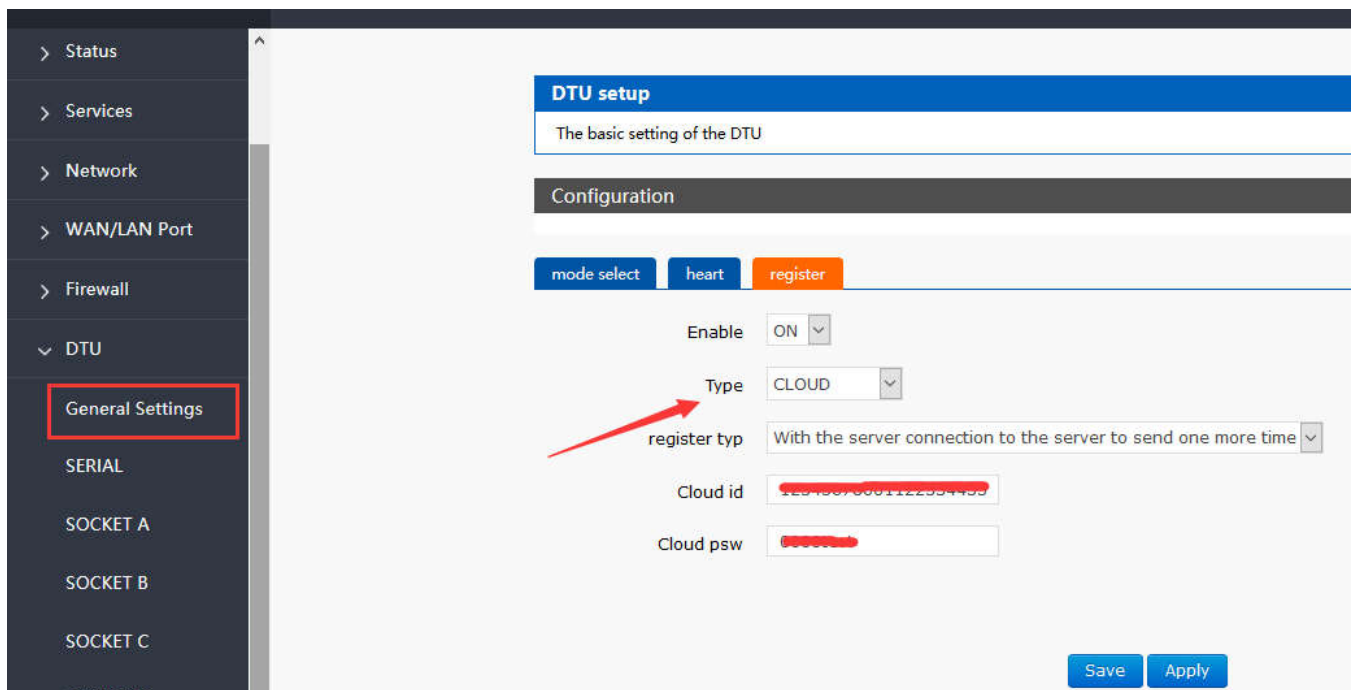

Figure78 USR-Cloud

Note: this function work only when socket A work at TCP Client mode.

Table13 AT commands

Command	Function	Default parameter
AT+ CLOUD	Set the cloud ID and password	
AT+ REGEN	Query/set enable register package	OFF
AT+ REGTP	Query/set data of register package	USER
AT+ REGSND	Query/set register sending type	DATA

1. Enable register function
AT+REGEN=ON
2. Set the type is USR-Cloud
AT+REGTP=CLOUD
3. Set the parameter of socket
AT+SOCKA=TCPC,clouddata.usriot.com,15000
4. Set the sending type
AT+REGSND=LINK
5. Set the cloud ID and password
AT+CLOUD=xxxxxxxxxxxxx,xxxxxxx
6. Restart
AT+Z

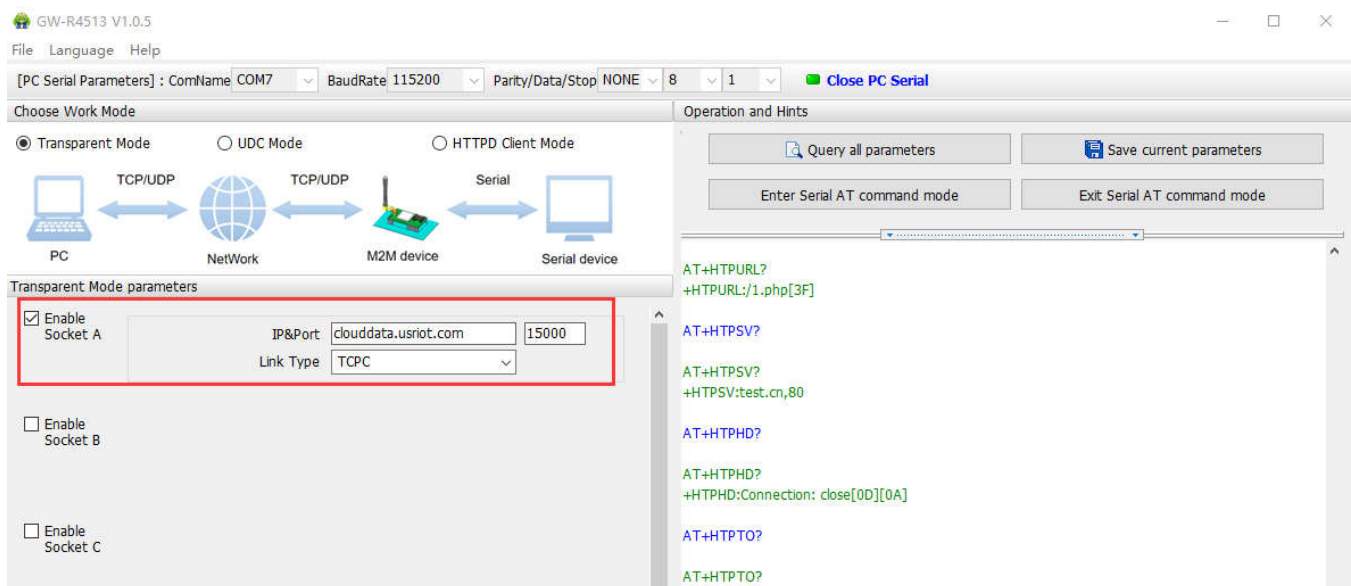

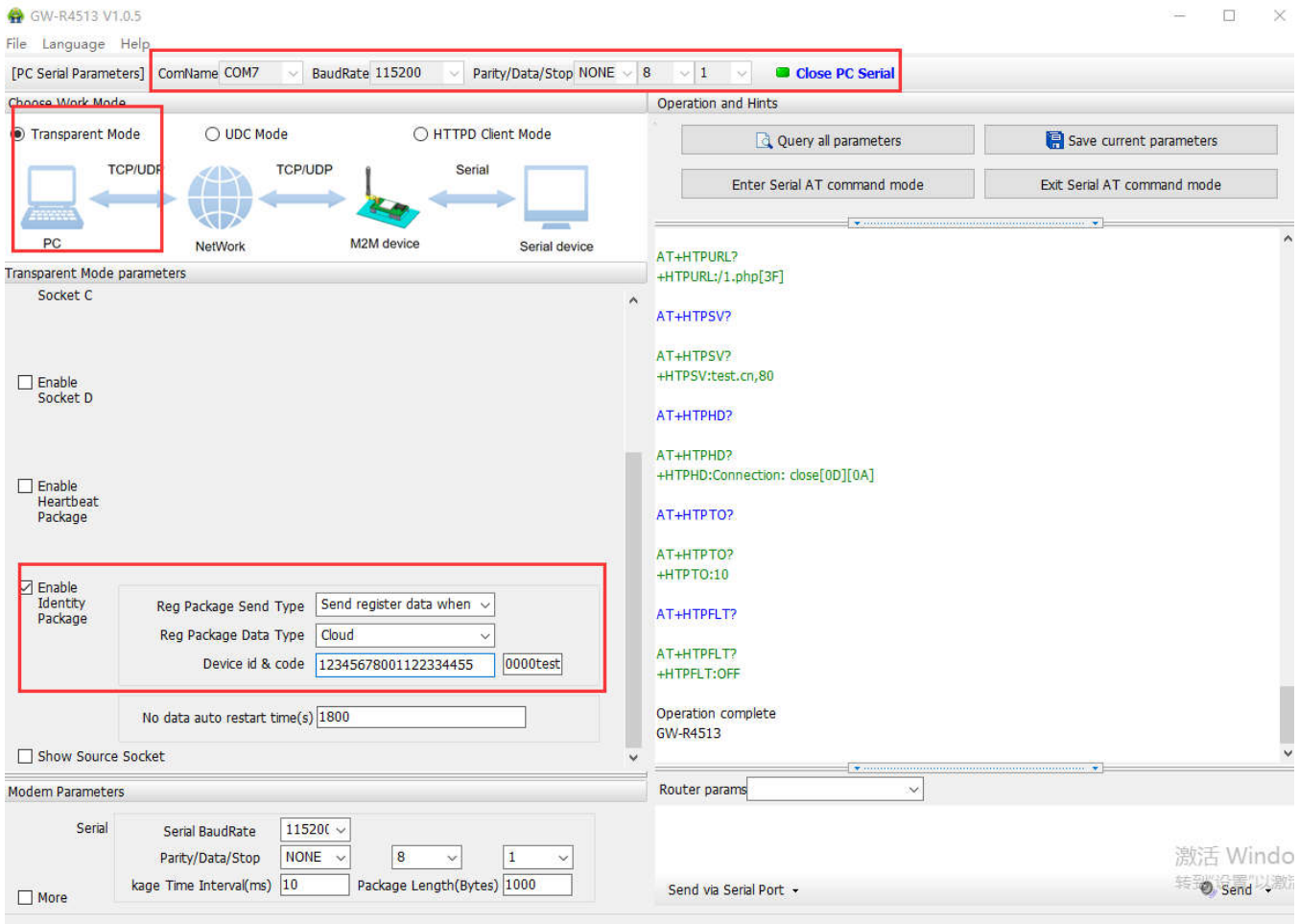

Figure79 setting software

5. Webpage Sitting

Connect PC and GW-R4513 with LAN port, or connect WLAN wireless, then login the webpage of setting.

Table14 GW-R4513 default parameter

Parameter	Default setting
SSID	GW-R4513-XXXX
IP of LAN port	192.168.1.1
User name	root
Password	root
WIFI key	12345678

Make PC join the WIFI GW-R4513-XXXX, enter 192.168.1.1 ,the user name and password both are root.

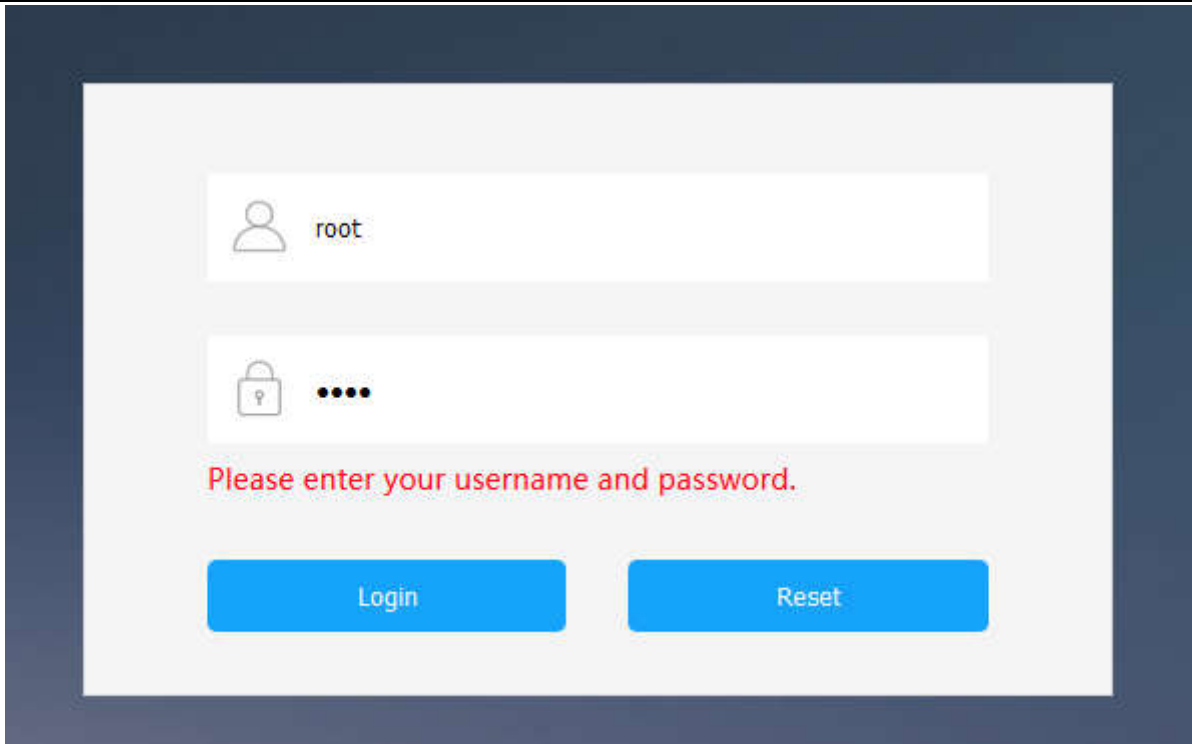

Figure80 login webpage











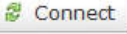







5.1. Web Function

Status	
System	
Hostname	GW-R4513
Firmware Version	V1.0.6(EN)
Local Time	Thu Nov 1 01:55:01 2018
Uptime	4h 51m 32s
Load Average	3.58, 3.74, 4.03

Figure81 status

Interfaces

Interface Overview

Network	Status	Actions
TEST  pptp-test	RX: 0.00 B (0 Pkts.) TX: 0.00 B (0 Pkts.)	 Connect  Stop  Edit  Delete
LAN  br-lan	Uptime: 4h 53m 1s MAC-Address: D8:B0:4C:00:00:92 RX: 3.23 MB (35219 Pkts.) TX: 6.24 MB (16053 Pkts.) IPv4: 192.168.1.1/24 IPv6: FDEB:24A3:B5B:0:0:0:1/60	 Connect  Stop  Edit  Delete
WAN_4G  eth1	Uptime: 4h 52m 46s MAC-Address: 2E:6F:B5:39:F8:B3 RX: 4.64 MB (10022 Pkts.) TX: 2.48 MB (28322 Pkts.) IPv4: 10.59.58.25/30	 Connect  Stop  Edit  Delete
WAN_WIRED  pppoe-wan_wired	RX: 0.00 B (0 Pkts.) TX: 0.00 B (0 Pkts.)	 Connect  Stop  Edit  Delete

 Add new interface...

Figure82 interface overview

GW-R4513

- Status
- > Services
- > Network
- > WAN/LAN Port
- Select Mode
- > Firewall
- > DTU
- > System

WAN/LAN Port setting

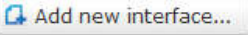
Switch WAN/LAN in Ethernet port 1. Restart to take effect.

Configuration

Mode of Ethernet Port 1

WAN/LAN
WAN ▾

Save
Apply

Figure83 mode of Ethernet port

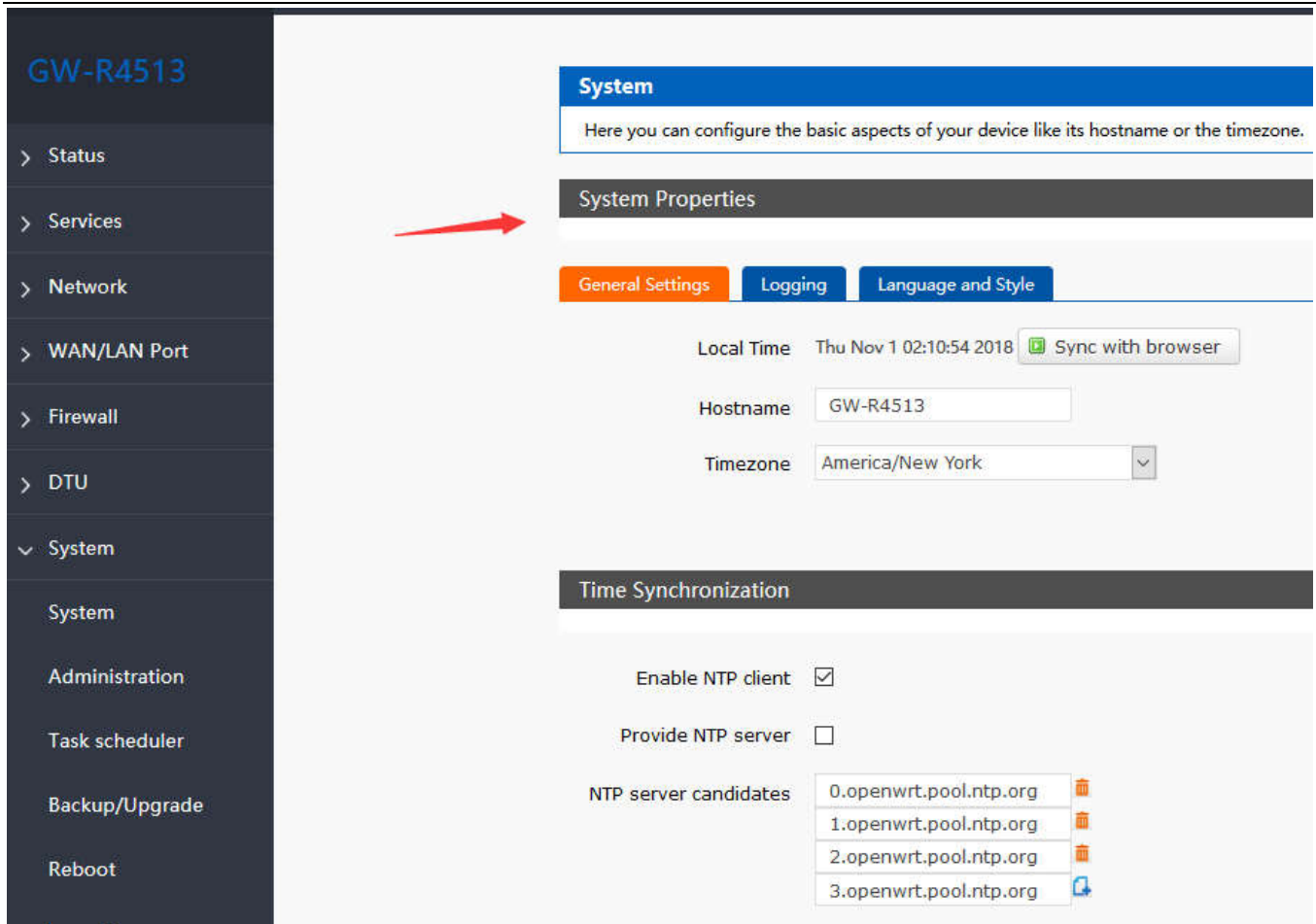

GW-R4513

- > Status
- > Services
- > Network
- > WAN/LAN Port
- > Firewall
- > DTU
- System
 - System
 - Administration
 - Task scheduler
 - Backup/Upgrade
 - Reboot

System

Here you can configure the basic aspects of your device like its hostname or the timezone.

System Properties

General Settings | Logging | Language and Style

Local Time: Thu Nov 1 02:10:54 2018 Sync with browser

Hostname:

Timezone:

Time Synchronization

Enable NTP client

Provide NTP server

NTP server candidates

- 0.openwrt.pool.ntp.org
- 1.openwrt.pool.ntp.org
- 2.openwrt.pool.ntp.org
- 3.openwrt.pool.ntp.org

Figure84 system properties

6.AT Commands

Table 15 AT commands

NO.	Command	Function
Version		
1	VER	Query version information
2	MAC	Query the MAC
3	ICCID	Query ICCID code
4	IMEI	Query IMEI code
4G		
5	AT+SYSINFO	Query the net info of device
6	AT+APN	APN address
7	AT+CSQ	Signal quality
8	AT+TRAFFIC	Query traffic information
9	AT+NETMODE	Query current network mode
System		
10	AT+UPTIME	Query running time

11	AT+WWAN	Query the IP of device
12	AT+LANN	Query/set the LAN of IP
13	AT+WEBU	Query/set the webpage account and password
14	AT+PLANG	Query/set the default language
15	AT+CLEAR	Recover to factory setting
16	AT+Z	Restart
17	AT+DHCPEN	Open/close DHCP Server
Remote monitor and upgrade		
18	AT+UPDATE	Query/set parameter of remote upgrade
19	AT+MONITOR	Query/set parameter of remote monitor
20	AT+HEARTPKT	Query/set parameter of remote heartbeat
System shell command		
21	AT+LINUXCMP	Execute system shell command
Serial command		
22	UART	Query/set parameter of serial port
23	UARTFT	Query/set serial port packing interval
24	UARTFL	Query/set the package length of serial port
Net command		
25	SOCKA	Query / setup socket A parameter
26	SOCKB	Query / setup socket B parameter
27	SOCKC	Query / setup socket C parameter
28	SOCKD	Query / setup socket D parameter
29	SOCKAEN	Query / setup whether to enable socket A
30	SOCKBEN	Query / setup whether to enable socket B
31	SOCKCEN	Query / setup whether to enable socket C
32	SOCKDEN	Query / setup whether to enable socket D
33	SOCKALK	Query socket A connection state
34	SOCKBLK	Query socket B connection state
35	SOCKCLK	Query socket C connection state
36	SOCKDLK	Query socket D connection state
37	SOCKIND	Query / setting enable or unable the source of data
Register command		
38	REGEN	Query / set enable registration package
39	REGTP	Query / set register package content type
40	REGDT	Query / set custom registration information
41	REGSND	Query / set register packet sending mode
42	CLOUD	Query/set the parameter of USR-Cloud
Heartbeat command		
43	HEARTEN	Query / settings enable heartbeat package
44	HEARTDT	Query / settings heartbeat data
45	HEARTTP	Query / settings heartbeat packet delivery mode
46	HEARTTM	Query / settings heartbeat packet interval

HTTPD command		
47	HTPTP	Query / setup HTTP operate mode
48	HTPURL	Query/setup URL
49	HTPSV	Query/setup remote IP and port
50	HTPHD	Query/setup head info of HTTP protocol
51	HTPTO	Query/setup the overtime time
52	HTPFLT	Query/setup enable or unable filter head

7. Contact Us

Company: Jinan USR IOT Technology Limited

Address: Floor 11, Building 1, No. 1166 Xinluo Street, Gaoxin District, Jinan, Shandong, 250101, China

Web: www.usriot.com

Support: h.usriot.com

Email: sales@usr.cn

Tel: 86-531-88826739/86-531-55507297

8. Disclaimer

This document provide the information of GW-R4513 products, it hasn't been granted any intellectual property license by forbidding speak or other ways either explicitly or implicitly. Except the duty declared in sales terms and conditions, we don't take any other responsibilities. We don't warrant the products sales and use explicitly or implicitly, including particular purpose merchantability and marketability, the tort liability of any other patent right, copyright, intellectual property right. We may modify specification and description at any time without prior notice.

9. Update History

Edition	Describe
V1.0.1	2018-04-10 establish