

2J6615B-868

868 MHz ISM Screw Mount

Key Features

868 MHz ISM

- 863-870 MHz

Screw Mount

Low Profile

Ground Plane Dependent

Customized Cable and Connector

Dimensions 77.3 × 15 mm

Certificates: IP67, IP69



1. Antenna and electrical specifications

Parameters	868 MHz ISM Antenna
Standards	ZigBee, ISM, SIGFOX, LoRa
Band (MHz)	868 MHz
Frequency (MHz)	863-870
Return Loss (dB)	~-21.3
VSWR	~1.2:1
Efficiency (%)	~42.1
Peak Gain (dBi)	~2.0
Average Gain (dB)	~-3.8
Impedance (Ohm)	50
Polarisation	Linear
Radiation Pattern	Omni-Directional
Max. Input Power (W)	25
Connector Type	Most RF Connectors (SMA-Male Standard)
Cable Length	Any Cable Length (300cm Standard)
Cable Type	Other Cables Available (RG174 Standard)

Antenna Measurement Conditions:

Mounted on 30x30 cm Metal Plate

200 cm RG174 Cable

Measured in Certified CTIA 3D Anechoic Chamber

2. Mechanical and environmental specifications

Specifications	2J6615B-868
Mounting Type	Screw Mount
Dimensions (mm)	77.3 x 15
Radome	ASA
Radome color	Black
Antenna Base	Zamak
Gasket	TPE
Operating Temperature (C)	-40 to +85
Storage Temperature (C)	-40 to +85
Substance Compliance	RoHS
Certificates	IP67, IP69K

3. Antenna parameters

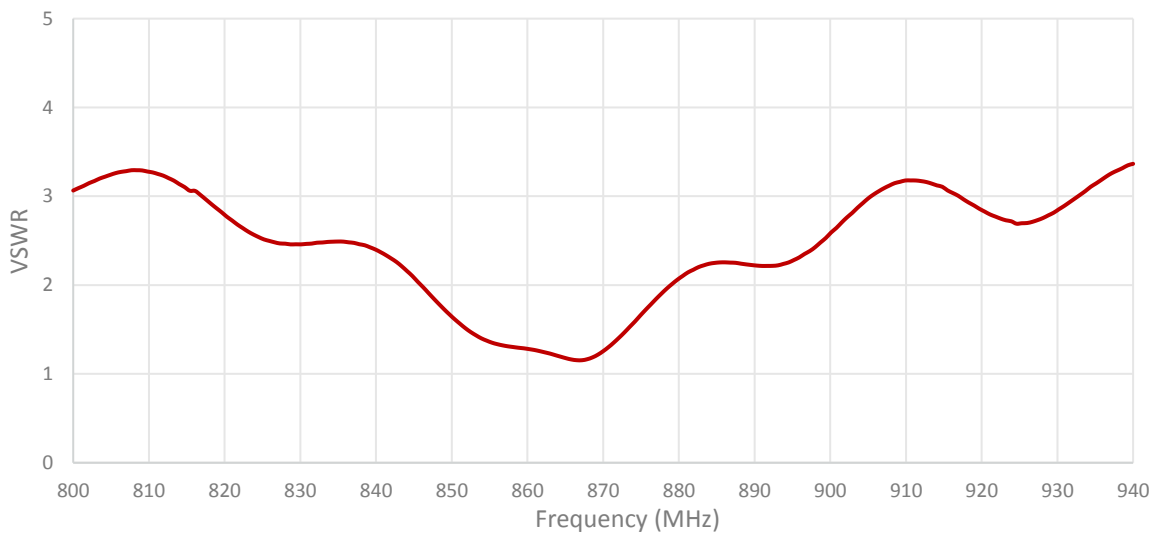
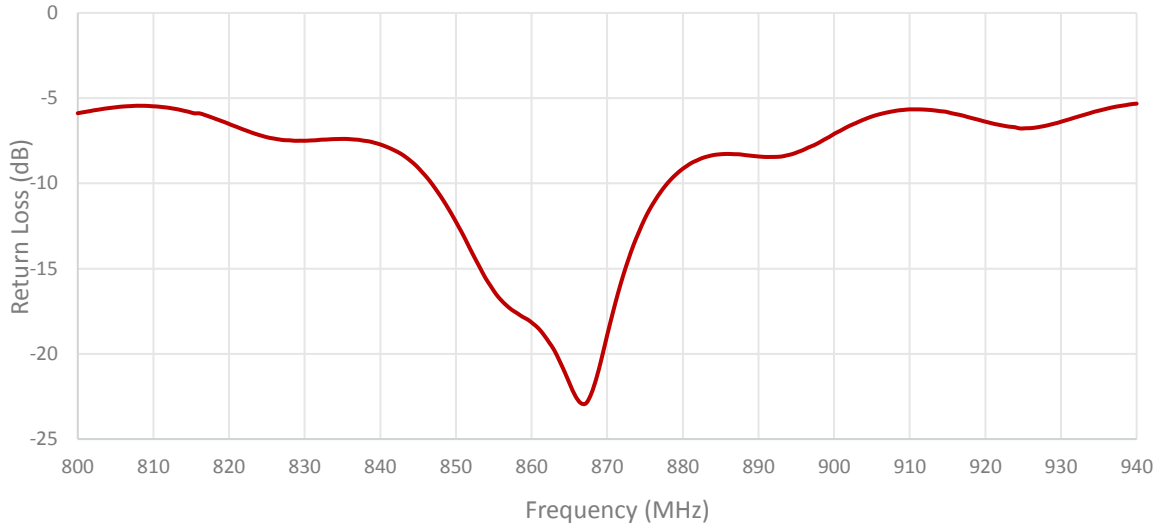

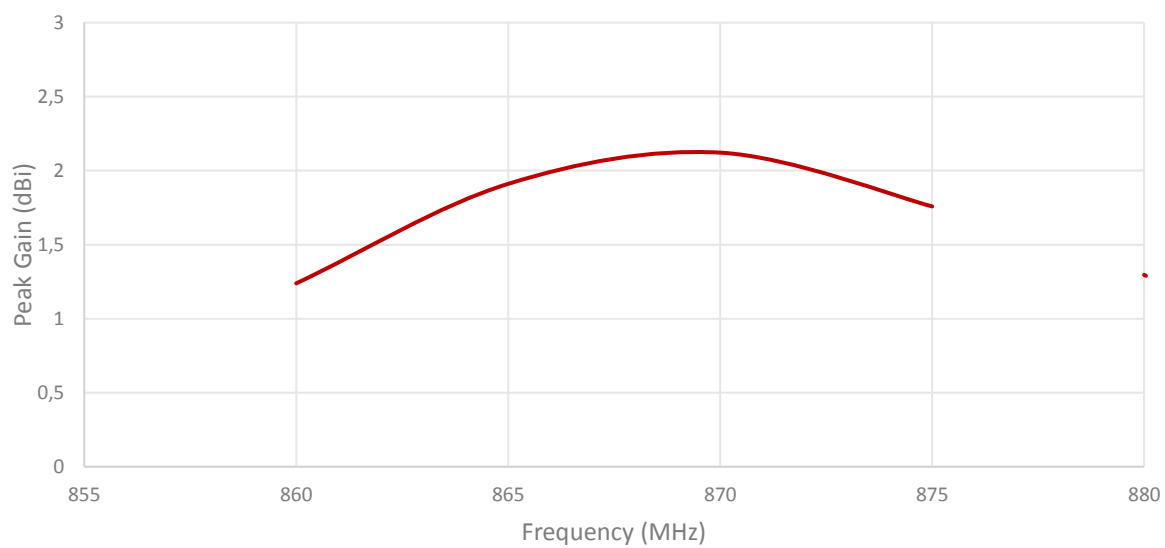
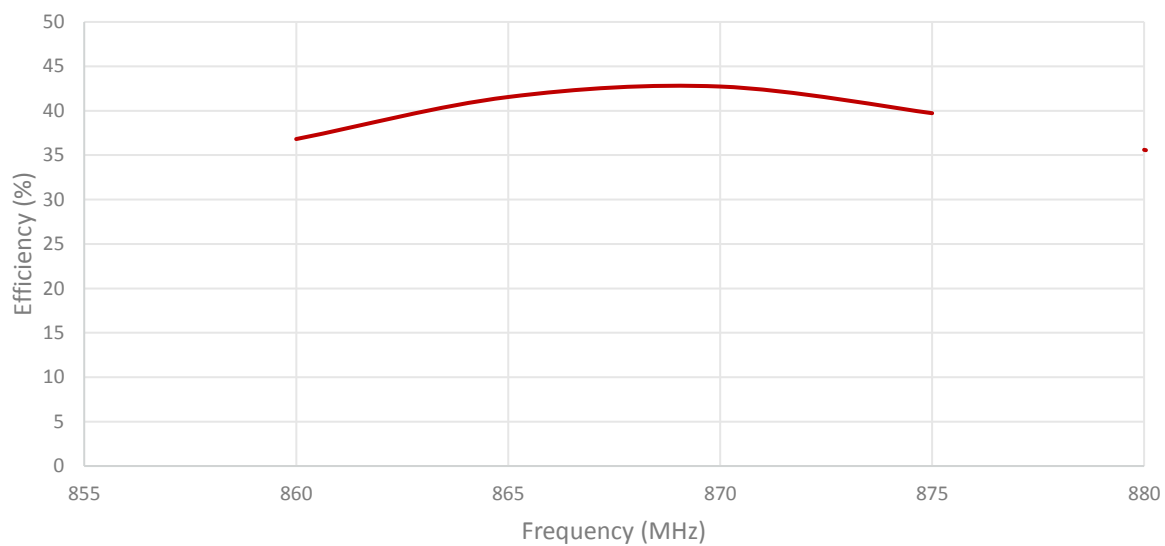

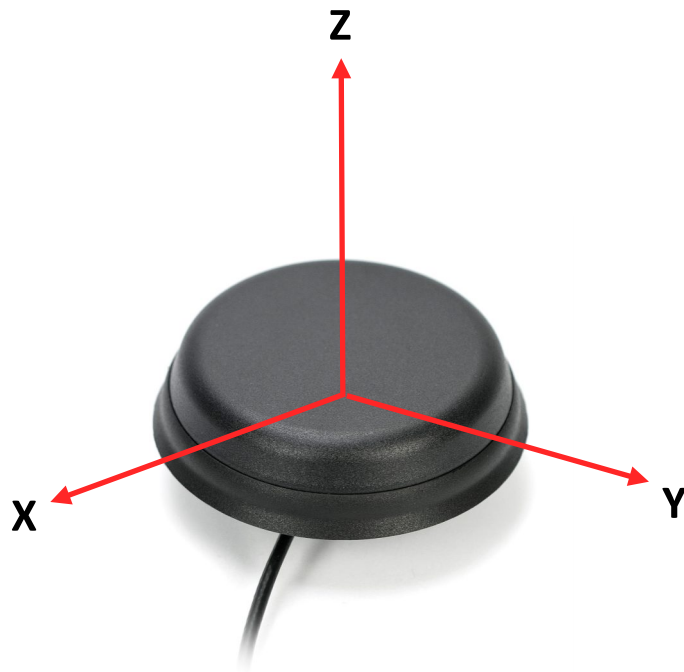
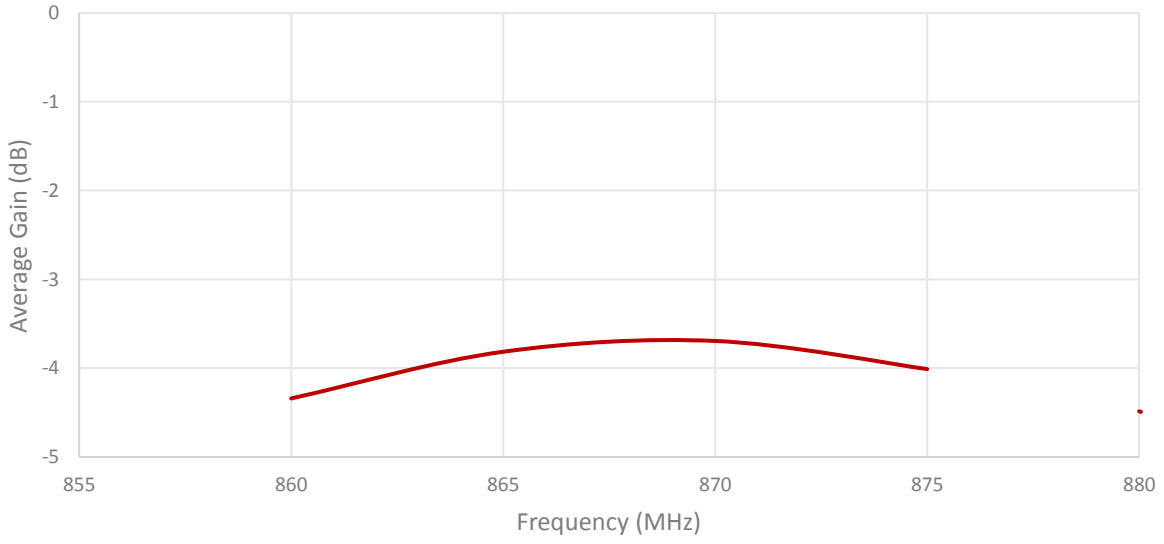

Radiation pattern reference

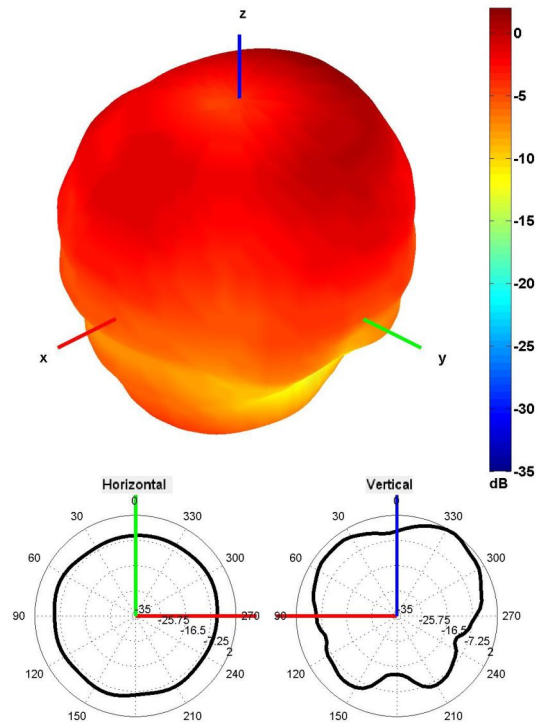

868 MHz Radiation pattern

4. Antenna drawings

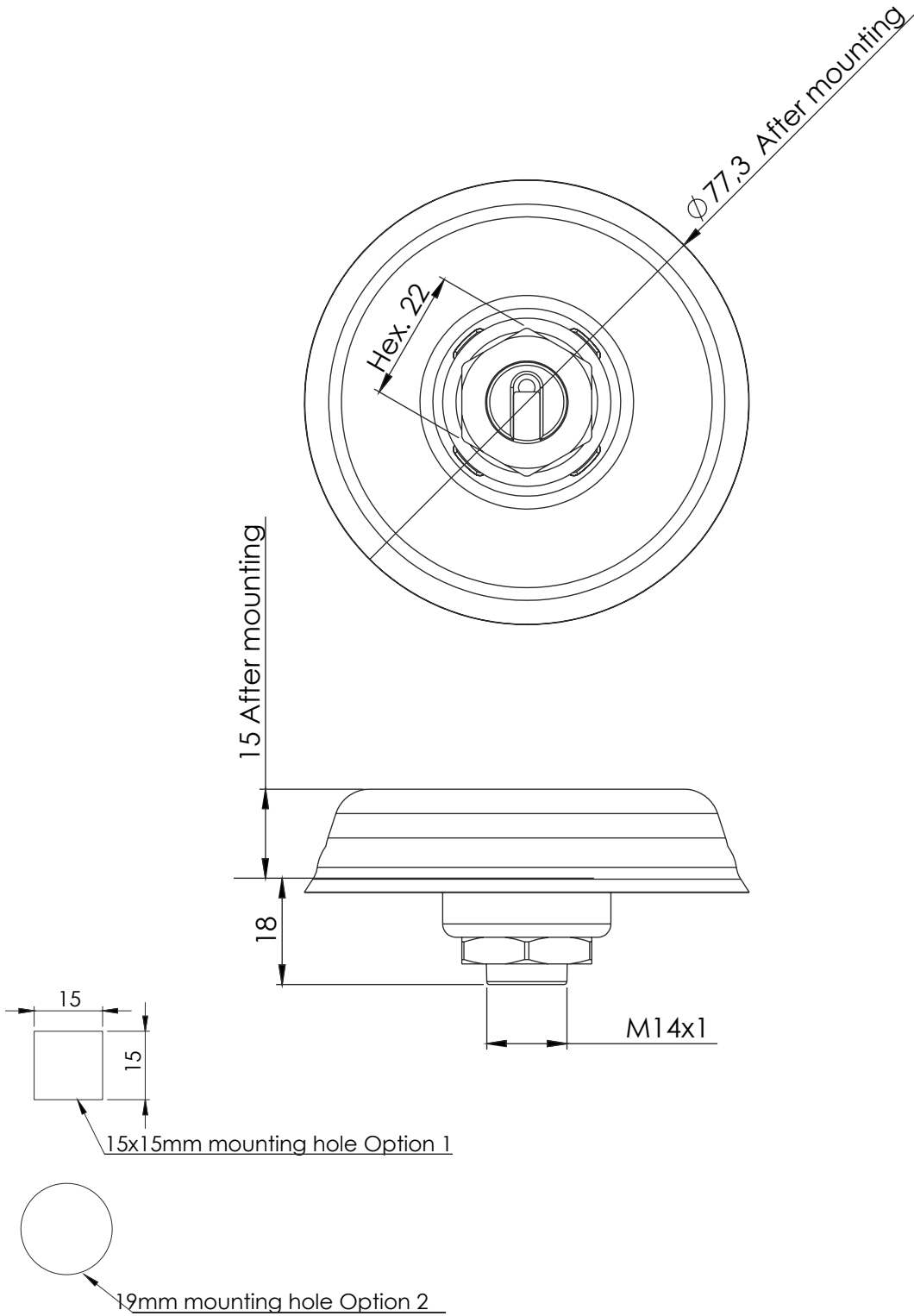

5. Antenna Images

