

## 2J6A24Ba

### CELLULAR / LTE MIMO Screw Mount

#### Key Features

**Cable 1: CELLULAR / LTE**

- 698-960 MHz
- 1710-2170 MHz
- 2500-2700 MHz

**Cable 2: CELLULAR / LTE**

- 698-960 MHz
- 1710-2170 MHz
- 2500-2700 MHz

Screw Mount

Anti-Rotation Mechanism

Ground Plane Dependent

Customizable Cable and Connector

IP67, IK09, IP69K

Dimensions  $\varnothing$  77.3 x 65.5 mm



## 1. Antenna and electrical specifications

Cable 1

Parameters	CELLULAR / LTE Antenna		
<b>Standards</b>	2G,3G and 4G		
<b>Band (MHz)</b>	700/850/900	1700/1800/1900/2100	2600
<b>Frequency (MHz)</b>	698-960	1710-2170	2500-2700
<b>Return Loss (dB)</b>	~-7.6	~-10.2	~-8.7
<b>VSWR</b>	~2.4:1	~1.9:1	~2.1:1
<b>Efficiency (%)</b>	~33	~32	~23
<b>Peak Gain (dBi)</b>	~-1.0	~-0.6	~-0.4
<b>Average Gain (dB)</b>	~-4.8	~-4.9	~-6.3
<b>Impedance (Ohm)</b>	50		
<b>Polarisation</b>	Linear		
<b>Radiation Pattern</b>	Omni-Directional		
<b>Max. Input Power (W)</b>	25		
<b>Connector Type</b>	SMA-Male Standard (Other Connectors Available)		
<b>Cable Length</b>	300 cm Standard (Any Cable Length Available)		
<b>Cable Type</b>	LMR100 Standard (Other Cables Available)		

Cable 2

Parameters	CELLULAR / LTE Antenna		
<b>Standards</b>	2G,3G and 4G		
<b>Band (MHz)</b>	700/850/900	1700/1800/1900/2100	2600
<b>Frequency (MHz)</b>	698-960	1710-2170	2500-2700
<b>Return Loss (dB)</b>	~-6.1	~-7.4	~-5.4
<b>VSWR</b>	~3.0:1	~2.5:1	~3.3:1
<b>Efficiency (%)</b>	~32	~33	~22
<b>Peak Gain (dBi)</b>	~-0.9	~-0.8	~-0.7
<b>Average Gain (dB)</b>	~-4.9	~-4.8	~-6.5
<b>Impedance (Ohm)</b>	50		
<b>Polarisation</b>	Linear		
<b>Radiation Pattern</b>	Omni-Directional		
<b>Max. Input Power (W)</b>	25		
<b>Connector Type</b>	SMA-Male Standard (Other Connectors Available)		
<b>Cable Length</b>	300 cm Standard (Any Cable Length Available)		
<b>Cable Type</b>	LMR100 Standard (Other Cables Available)		

**Antenna Measurement Conditions:**

Mounted on 30x30 cm Ground Plane

200 cm of Cable LMR100

Measured in Certified CTIA 3D Anechoic Chamber

## 2. Mechanical and environmental specifications

Specifications	2J6A24Ba
<b>Mounting Type</b>	Screw Mount
<b>Dimensions (mm)</b>	Ø 77.3 x 66.5
<b>Radome</b>	PC/ABS UV Stable
<b>Radome color</b>	Black
<b>Antenna Base</b>	Zamak
<b>Gasket</b>	TPE
<b>Operating Temperature (C)</b>	-40 to +85
<b>Storage Temperature (C)</b>	-40 to +85
<b>Substance Compliance</b>	RoHS
<b>Certificates</b>	IP67, IK09, IP69K

### 3. Antenna parameters

**Cable 1: CELLULAR / LTE**

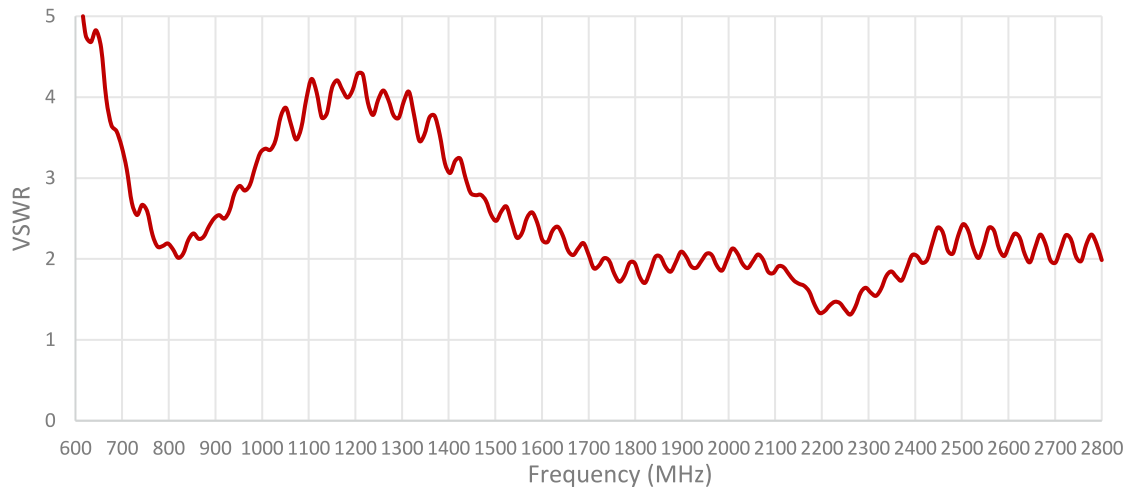
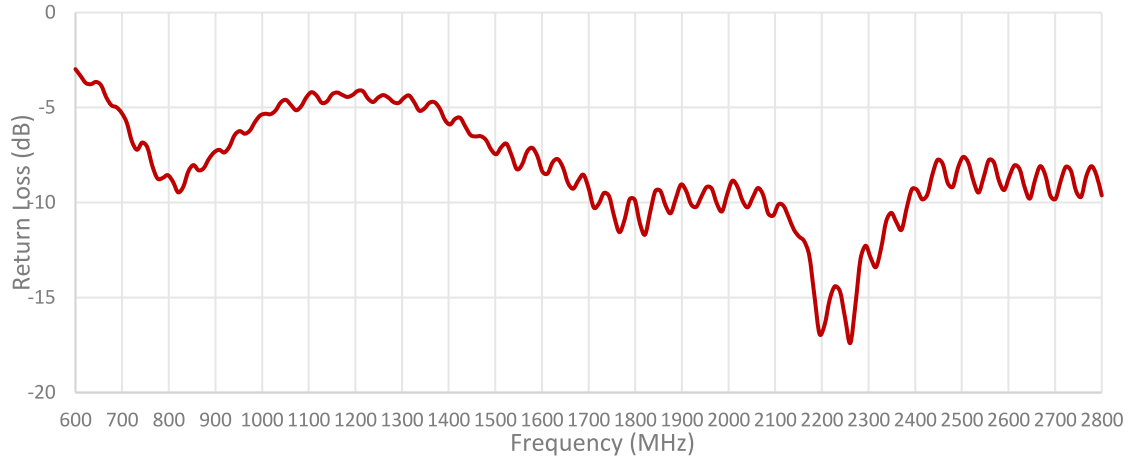

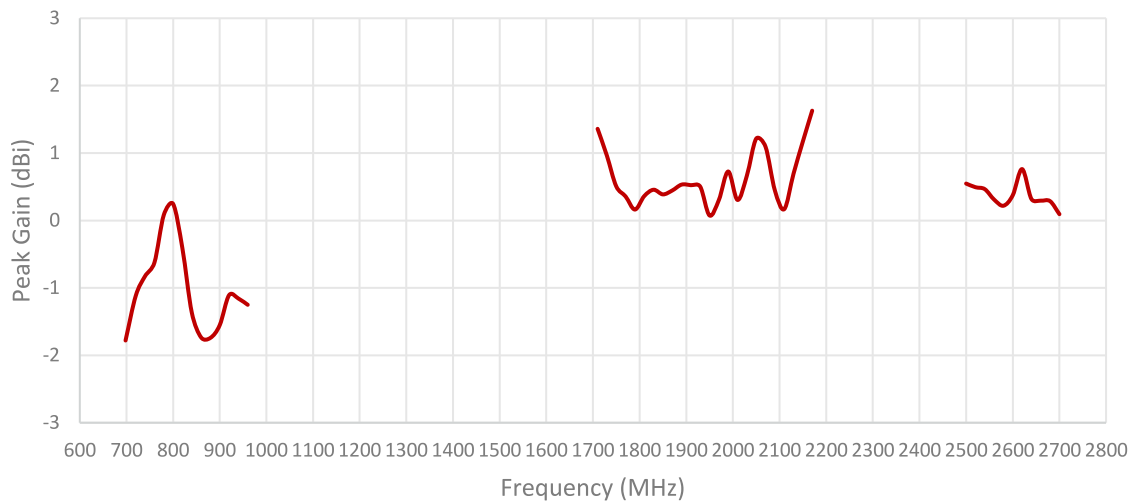
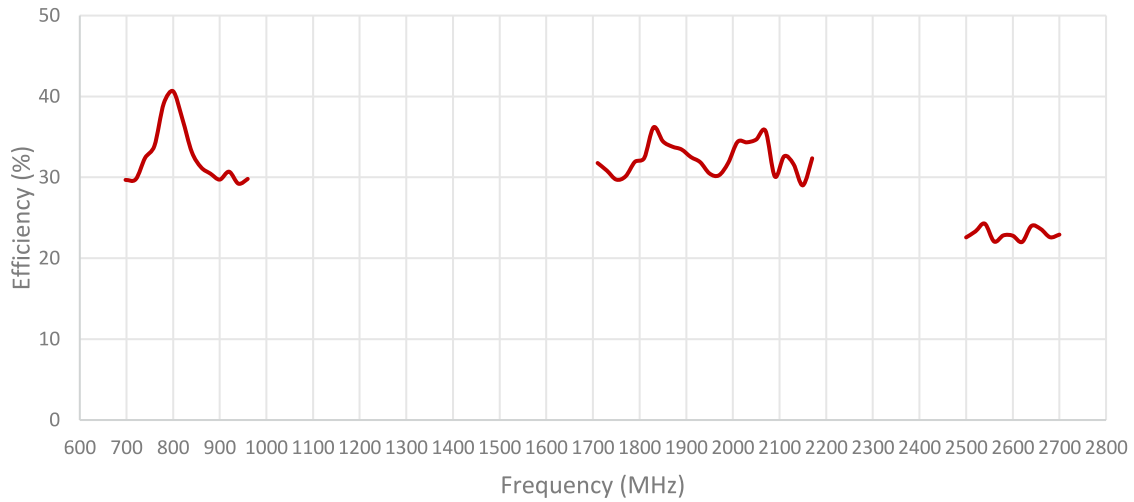

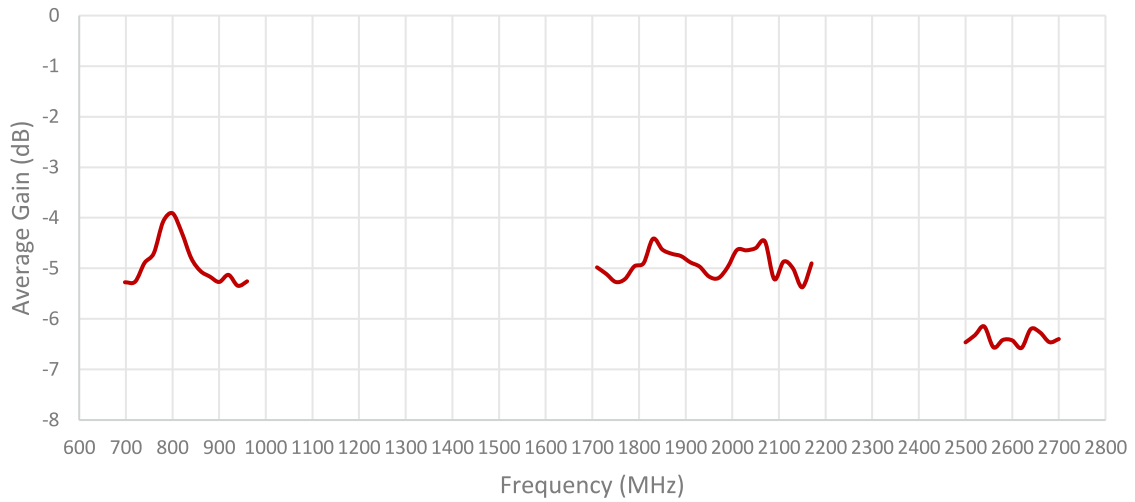

**Cable 2: CELLULAR / LTE**

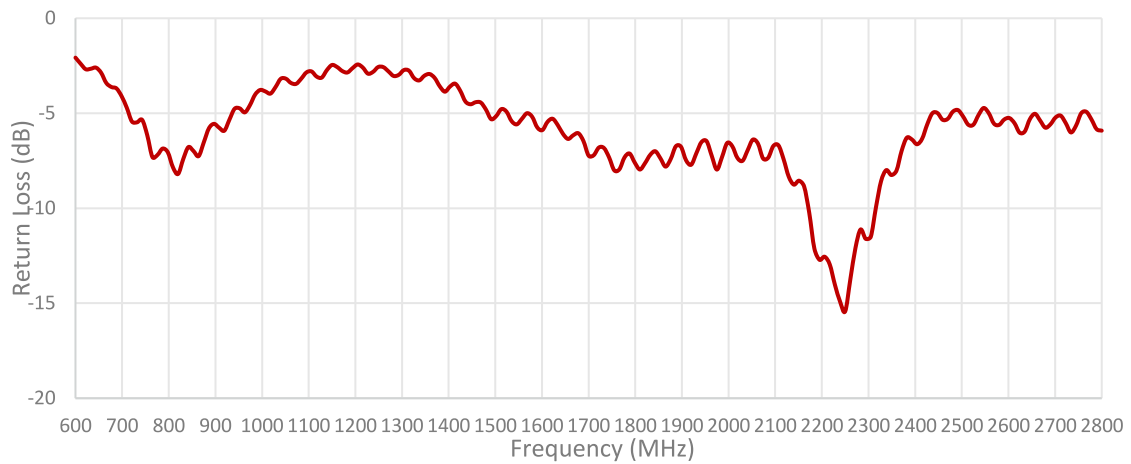

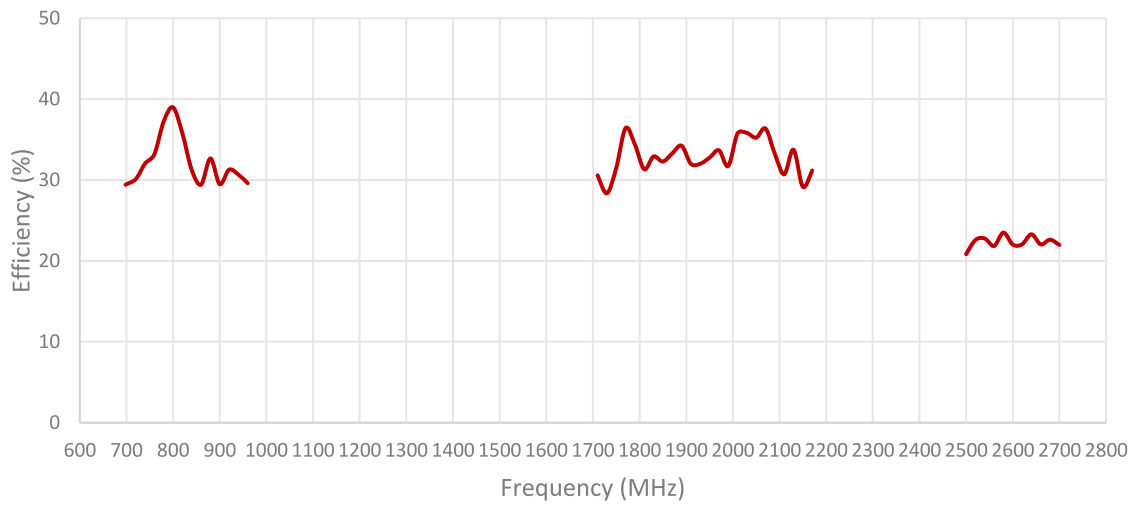
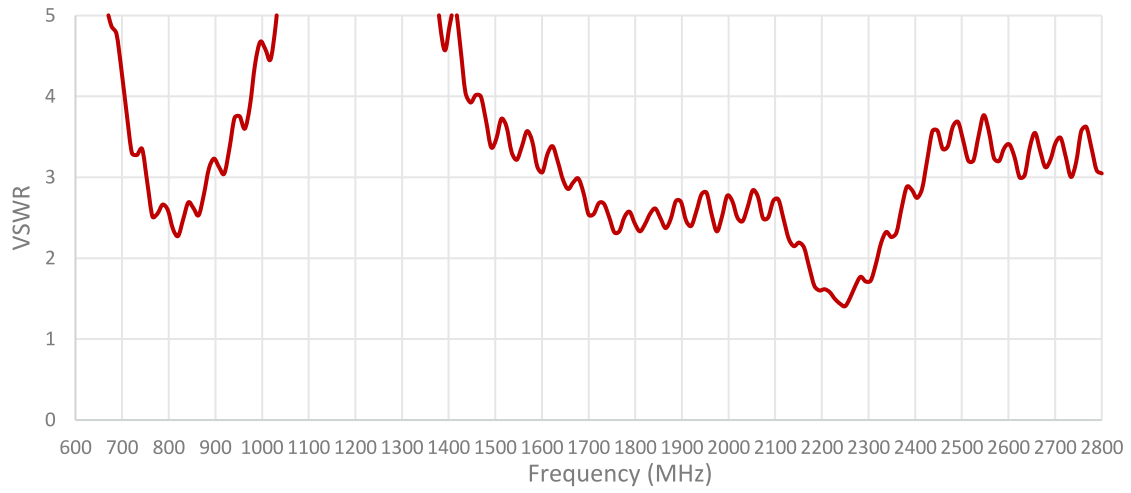

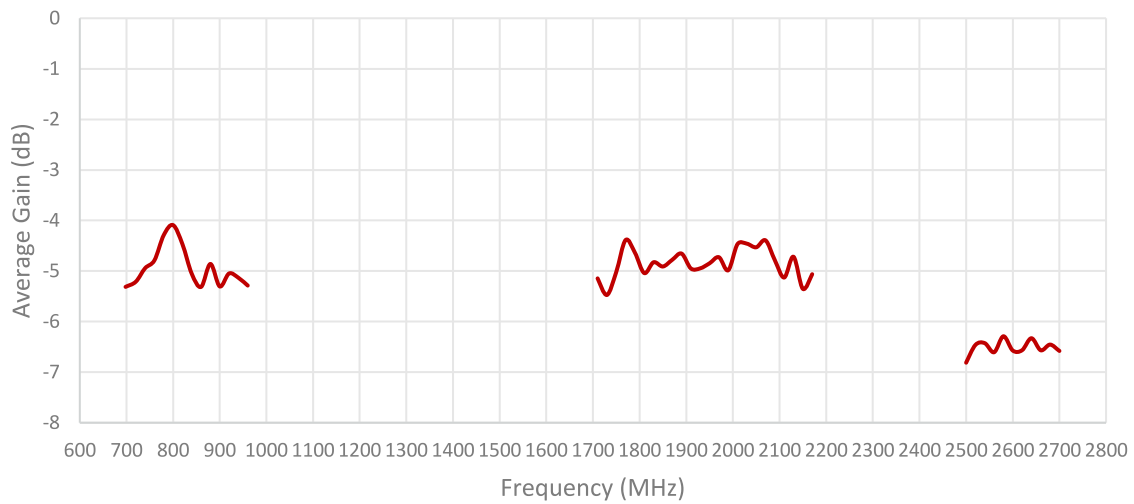
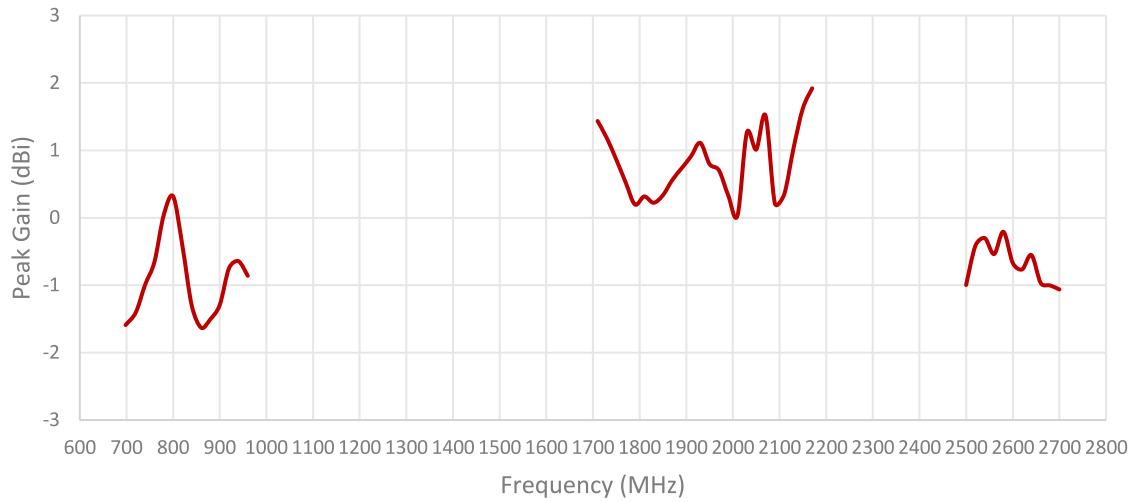



### ISOLATION FOR CABLE 1 AND 2

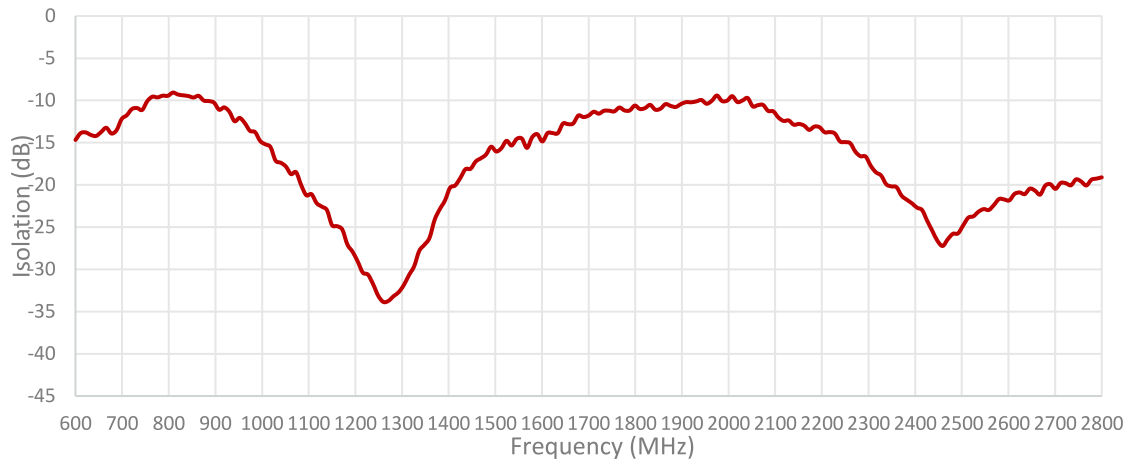

### ENVELOPE CORRELATION COEFFICIENT FOR CABLE 1 AND 2

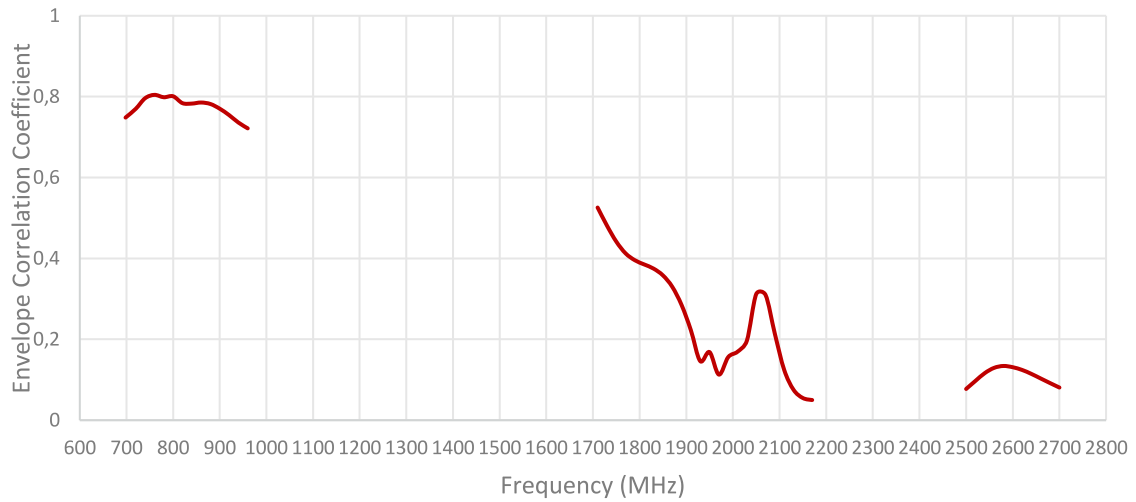

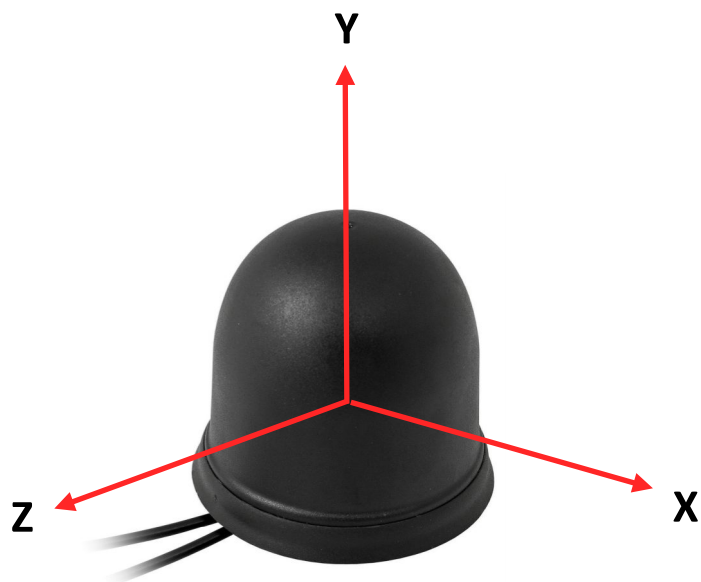

Radiation pattern reference

**Cable 1: CELLULAR / LTE**

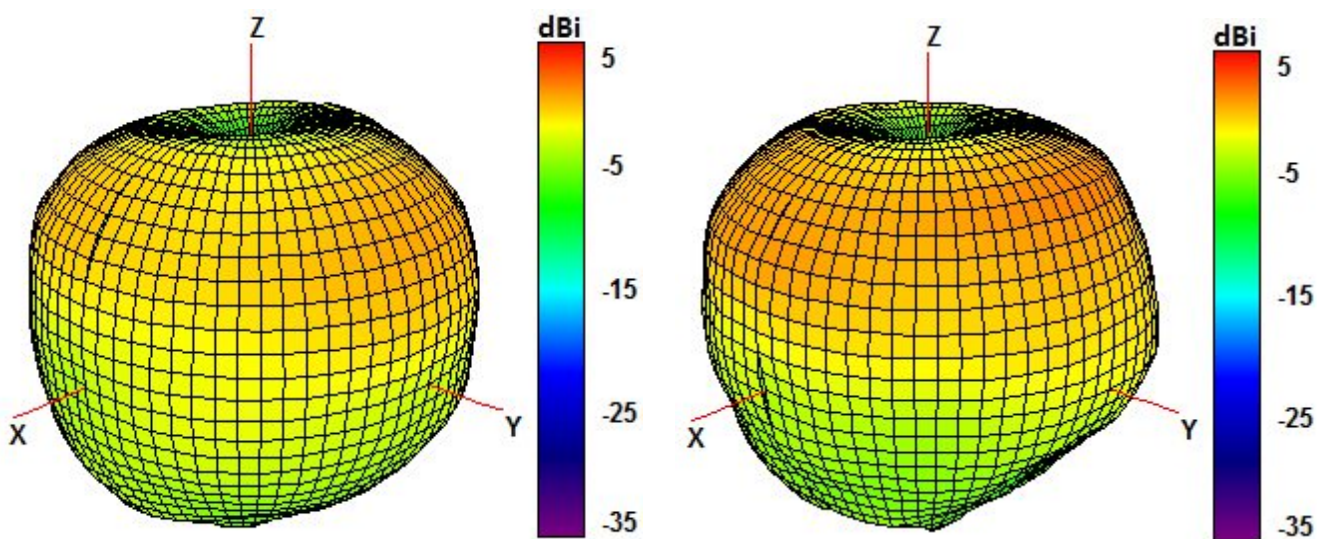

750 and 850 MHz Radiation pattern

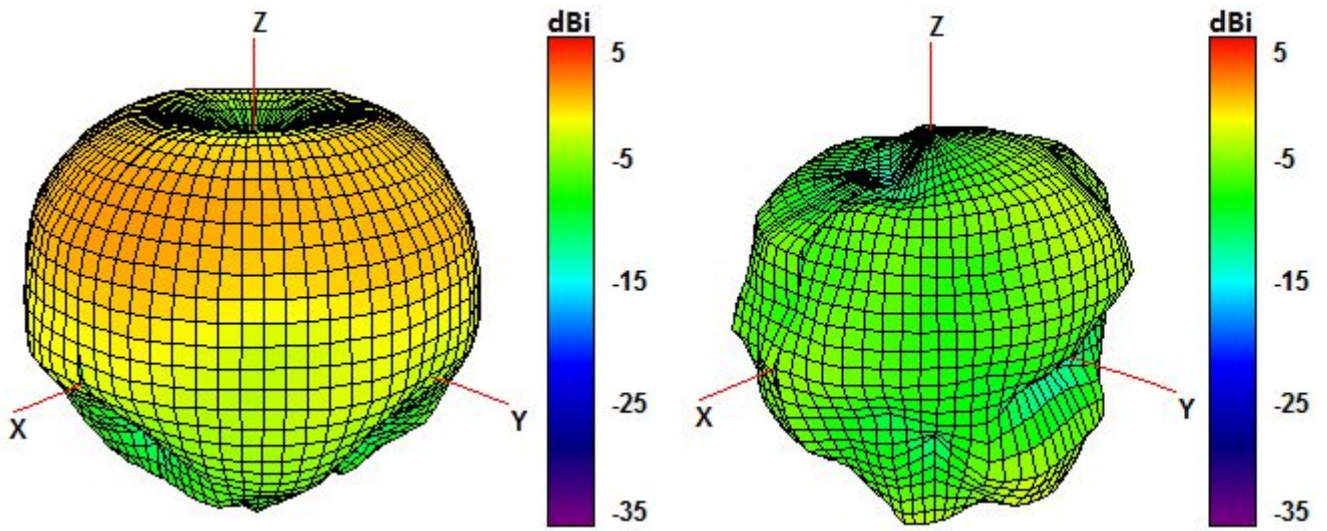

940 and 1750 MHz Radiation pattern

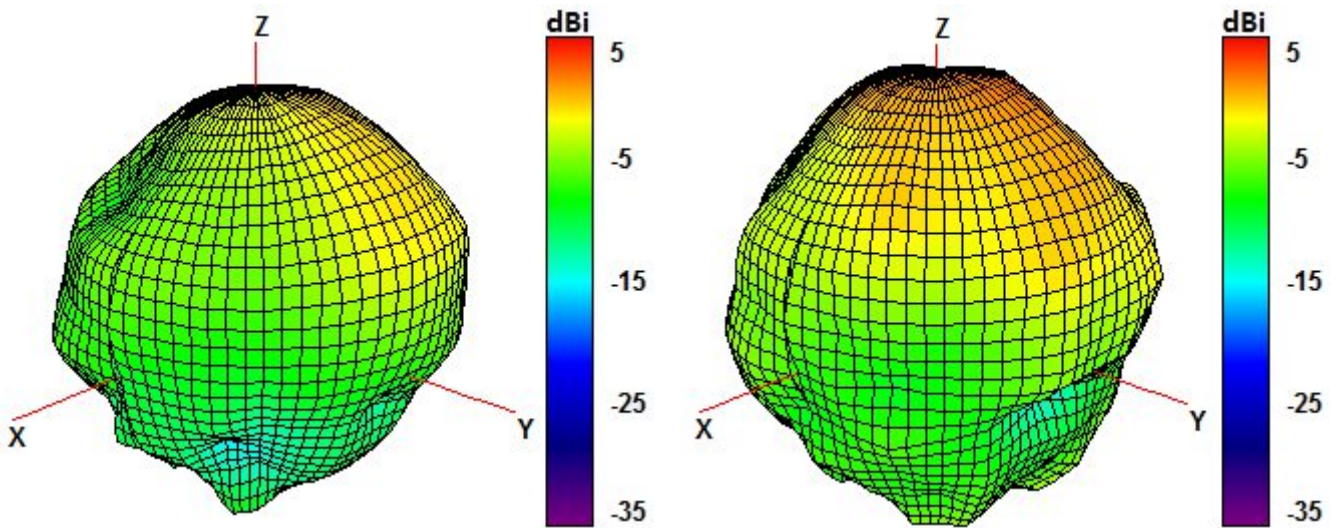

1850 and 1950 MHz Radiation pattern

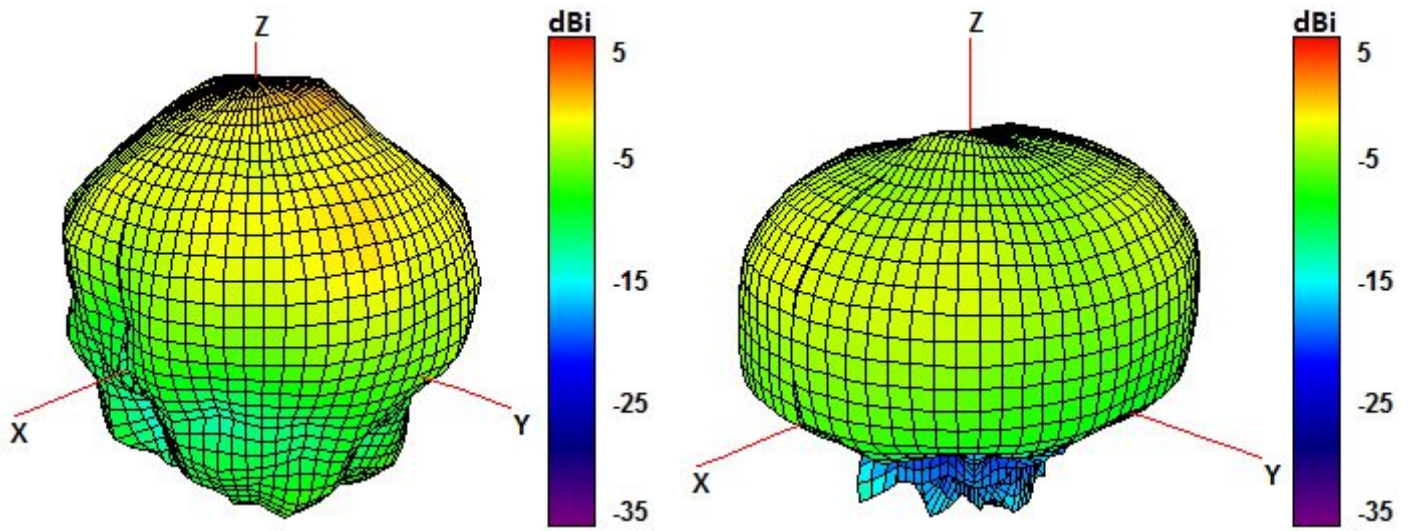

2100 and 2600 MHz Radiation pattern

**Cable 2: CELLULAR / LTE**

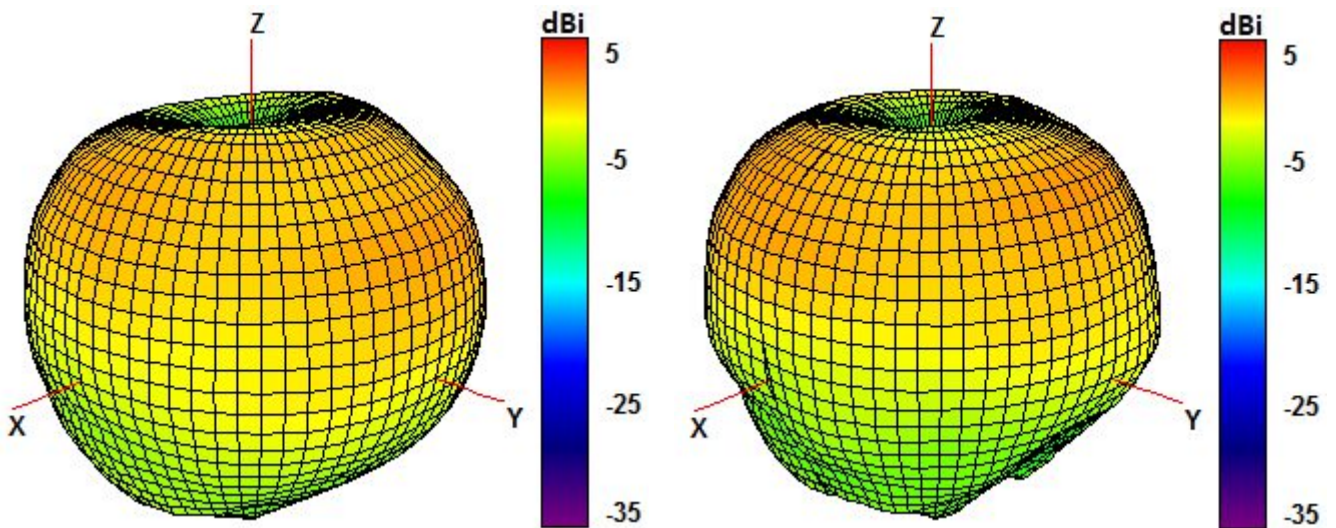

750 and 850 MHz Radiation pattern

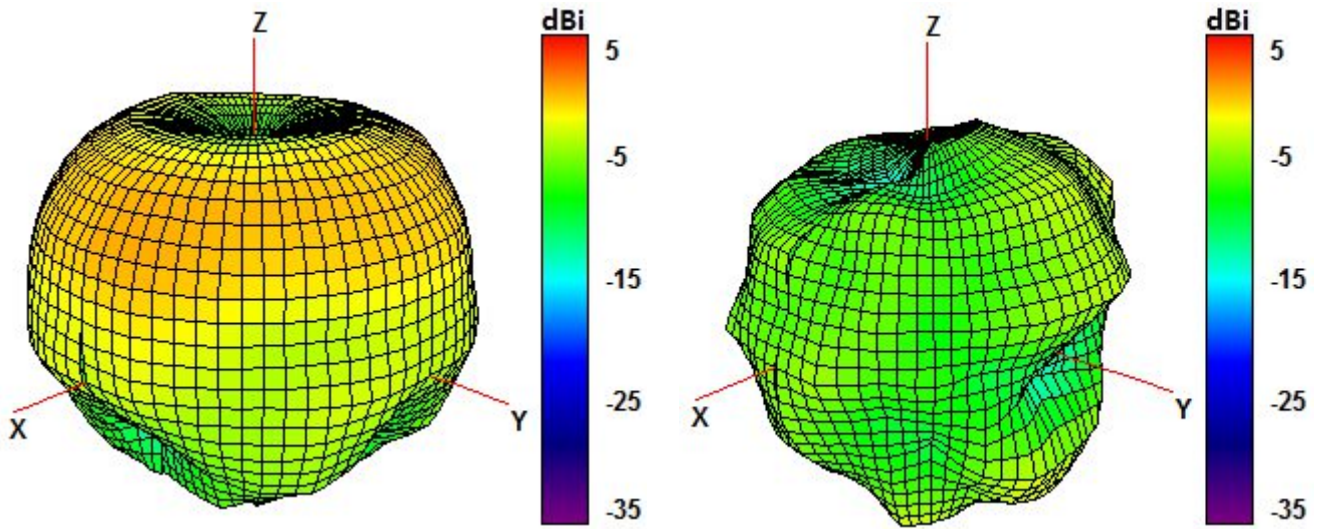

940 and 1750 MHz Radiation pattern

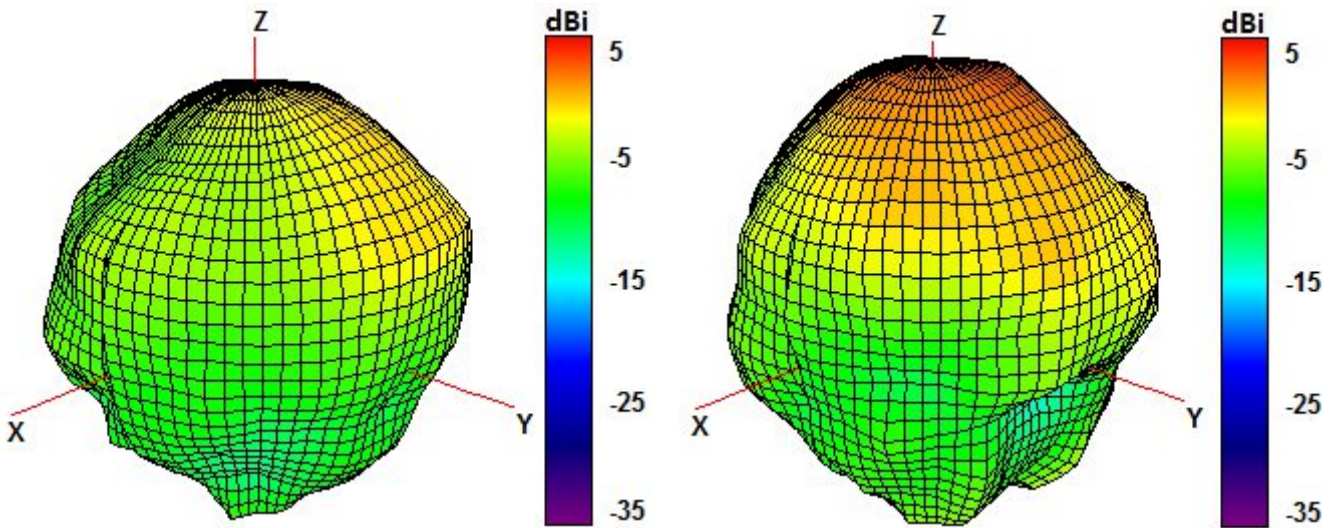

1850 and 1950 MHz Radiation pattern

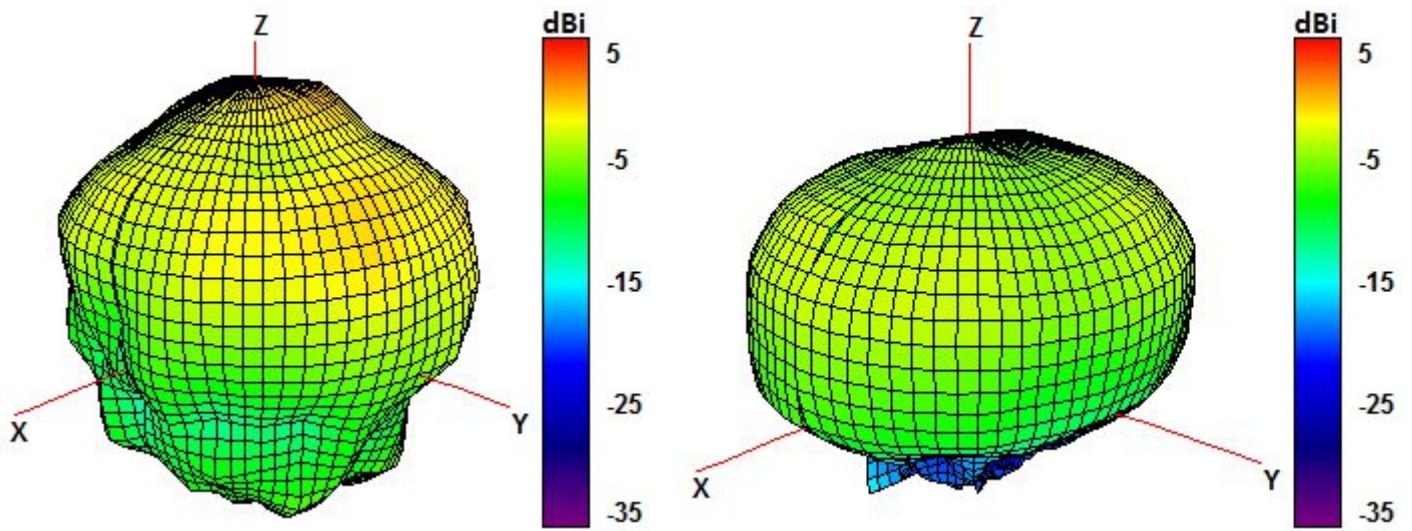

2100 and 2600 MHz Radiation pattern

## 4. Antenna drawings

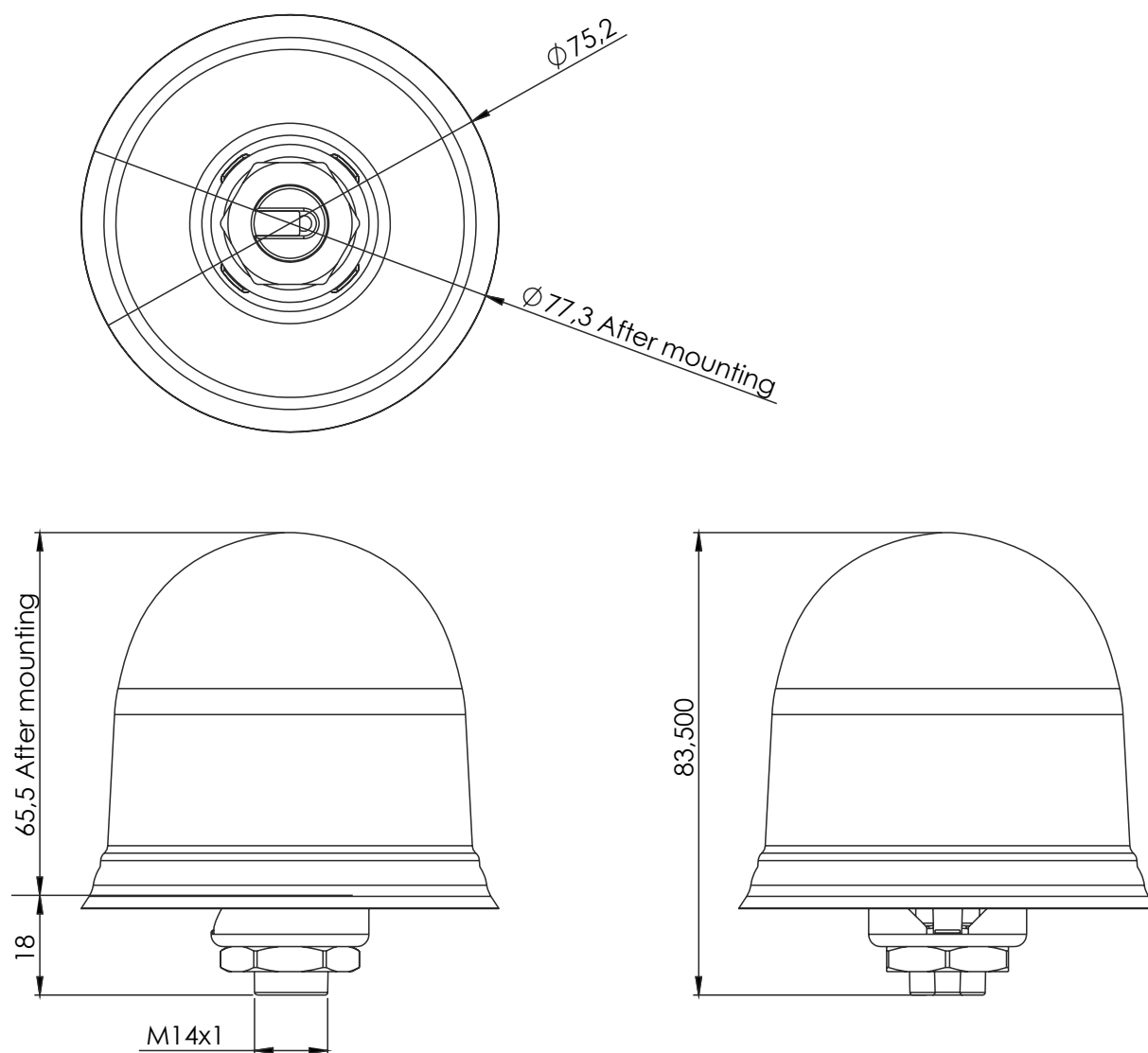

## 5. Antenna Images

